

BEGINNING IN THIS ISSUE

# The Practical Electrician

PRICE 10 CENTS

FEBRUARY, 1911

Vol. III

No. 11

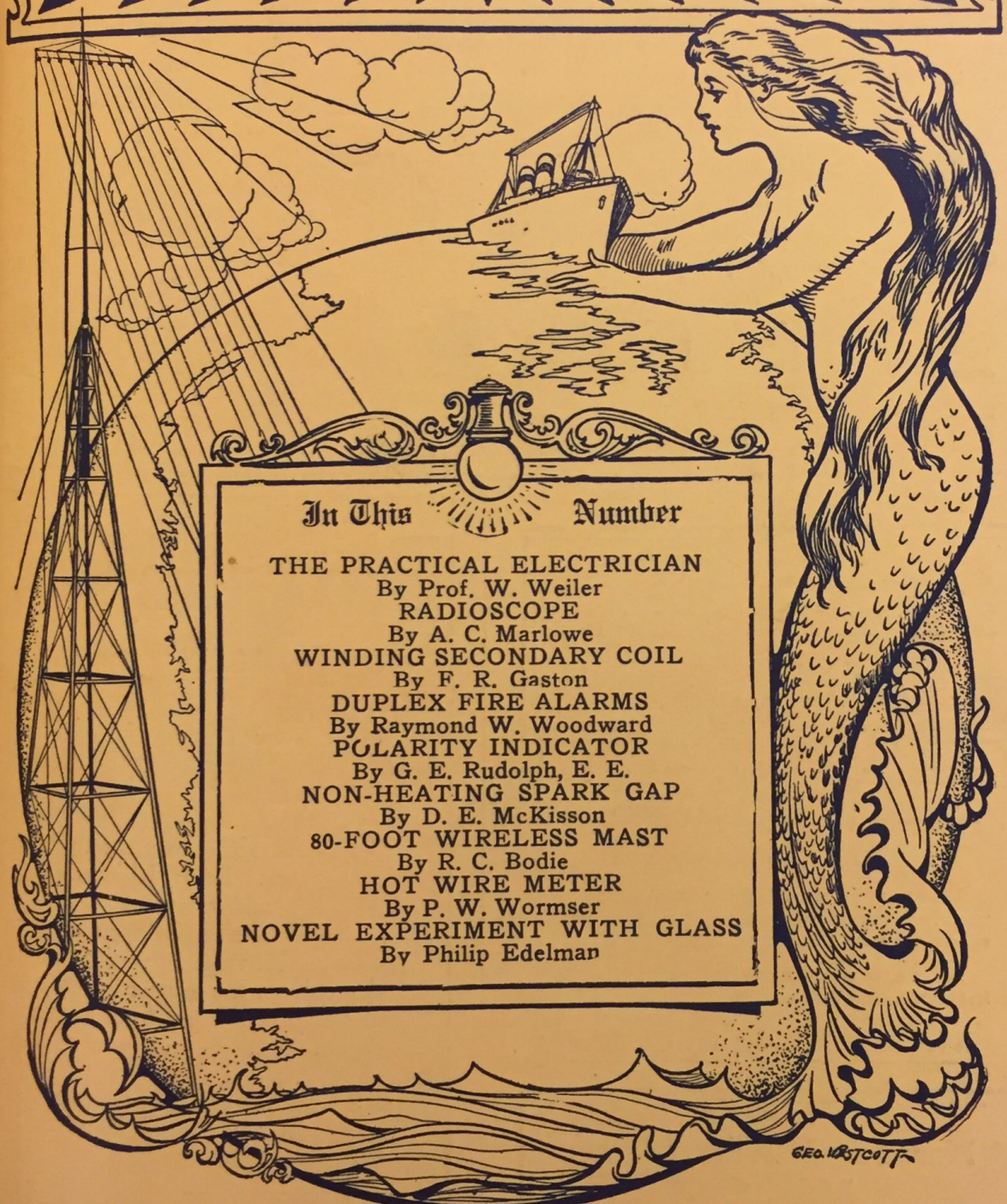
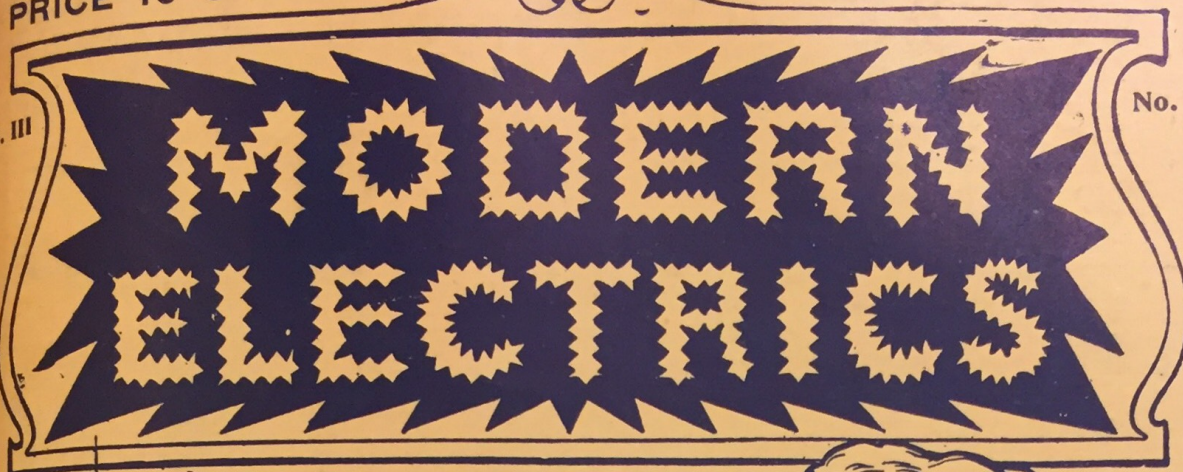

In This  Number

**THE PRACTICAL ELECTRICIAN**  
By Prof. W. Weiler  
**RADIOSCOPE**  
By A. C. Marlowe  
**WINDING SECONDARY COIL**  
By F. R. Gaston  
**DUPLEX FIRE ALARMS**  
By Raymond W. Woodward  
**POLARITY INDICATOR**  
By G. E. Rudolph, E. E.  
**NON-HEATING SPARK GAP**  
By D. E. McKisson  
**80-FOOT WIRELESS MAST**  
By R. C. Bodie  
**HOT WIRE METER**  
By P. W. Wormser  
**NOVEL EXPERIMENT WITH GLASS**  
By Philip Edelman

**THE SPIRIT OF WIRELESS**

**"THE ELECTRICAL MAGAZINE FOR EVERYBODY"**

Copyright 1911, by MODERN ELECTRICS PUBLICATION

N. S. E.

INSULATORS from 1,000 to 1,000,000 VOLTS



INSULATION

Standard of the World

Adopted by U. S. NAVY

and all Commercial Wireless Companies



Electrose Mfg. Co., 127-137 N. 10th St. Brooklyn, N. Y.  
130-240 N. 11th St.

A TWO-FOOT  
MODEL AEROPLANE  
\$1.00

BLERIOT, CURTISS,

WRIGHT, SANTOS-DUMONT,  
ANTOINETTE, DEMOISELLE,  
OR FARMAN

Upon receipt of \$1 we will mail  
you postpaid a model of any of the  
above types of Aeroplanes.

All parts are furnished with simple  
instructions for every model.

Models Made to Order

a Specialty

National Aeroplane  
Mfg. Co.

385 EAST FOURTH STREET  
NEW YORK CITY

When writing, please mention "Modern Electrics."

Patents  
Trade-marks  
Designs  
Copyrights

YOUR ability to protect your  
patent from infringement  
depends largely on the pre-  
sentation of the original application.  
The market value of your patent  
depends on the manner in which  
the invention is set forth in the  
claims. Let me tell you more  
about it.  
Send for my booklet on Patents,  
Trade-Marks, Designs, Copyrights.

LANGDON MOORE  
902a F STREET, WASHINGTON, D. C.  
Ex. Asst. Examiner U. S. Pat. Off.

When writing, please mention "Modern Electrics."

# Will You Try Johnson's Wood Finishes at our Expense

You can get samples of Johnson's Wood Finishes together with copy of their 25c Booklet, "The Proper Treatment for Floors, Woodwork and Furniture," absolutely Free. This booklet tells how to finish or refinish your woodwork, floors, and furniture—in fact, how to finish and refinish all wood.

Read Free Offer below.

## Johnson's Prepared Wax

used for polishing all kinds of furniture (including pianos), woodwork and floors. Used also for finish over dyed wood surfaces producing that beautiful artistic dull finish so much in vogue at the present time.

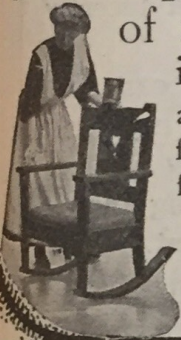

## Johnson's Wood Dye

—not a varnish stain—but a deep-seated Dye that penetrates the wood and fixes a deep, rich, permanent color. Made in 14 attractive shades With Johnson's Wood Dye you can make inexpensive soft woods as beautiful and artistic as the most expensive hard woods.



## Johnson's Kleen Floor

For cleaning all polished floors, stairs, and varnished surfaces, keeping them in perfect condition. Applied with a cloth and rubbed dry. removes all spots and discolorations in and above the varnish. After using, give the surface a coat of Johnson's Prepared Wax and your floors and stairs will look better.



## Johnson's Under-Lac

a thin, elastic spirit finish far superior to varnish or shellac. Not thick or sticky or slow-drying like varnish—neither does it dry too quickly like shellac. Especially good on linoleums and oilcloth, bringing out the pattern and giving a finish as glossy as new. Protects from wear—makes cleaning easy. Dries hard in an hour. Gallons \$2.50—quarts 70c—pints 40c.



## Free Booklet and Sample Offer

Present coupon shown here to your leading paint dealer for samples and free book—or if more convenient mail coupon to us and we will send you, free and postpaid, book and samples—any two of the above in which you are interested. All we ask is that you test the samples and report results to us, asking your dealer to supply your future needs.



S. C. Johnson & Son, Racine, Wis.  
"The Wood Finishing Authorities"

## Coupon

Mail me Free 25c. Book and Samples of the following:.....

Name .....

Address.....

Dealer's Name.....

# YOU MUST BE MASTER of a Trade to be Master of a Business LEARN ELECTRICITY

**T**HE son of a Millionaire Englishman came to America recently to take a course in the New York Electrical School.

His father will soon turn over to him the full care and responsibility of a huge business that has an immense plant. The young man intends to manage the business himself. He wants to know whether the business is running right. To do this he must have a working knowledge of every line of work that enters into the conduct of the plant.

Electricity plays a large part in his plant. So he decided to learn the Electrical business.

The New York Electrical School was selected as the best school to give him a thoro knowledge of electricity in both theory and practice.

We taught him Electricity. He left New York for England prepared to handle every electrical problem that might arise, and to do the work himself if necessary.

You can learn Electricity and it will pay you to do so, whether you want to earn your daily bread or to rise to the head of some great business.

Electricity is the best paying industrial business in America say Government statistics.

## Learn the Electrical Business

WRITE FOR FULL INFORMATION  
ADDRESS

**New York Electrical  
School**

26 W 17th St., New York, N. Y.

SEND THIS COUPON

NEW YORK ELECTRICAL SCHOOL,  
26 W. 17th St., New York, N. Y.

Please send me full information about your course  
in electricity.

NAME .....

ADDRESS .....

# Modern Electrics

VOL. III.

FEBRUARY, 1911.

No. 11.

## The Practical Electrician

A Popular Course in Electricity on the Construction of Electrical Apparatus and Experiments to be Conducted with them

By Professor W. Weiler, of the University of Esslingen, (Germany)

(Translation by H. Gernsback)

### CHAPTER I.

#### Sources of Electricity: Galvanic Batteries.

##### 1. Galvani's Experiment.

In his pamphlet of 1791: "De viribus electricitatis in motu musculari commentarius"\*, Galvani† records the following experiment: "If a freshly killed frog is suspended by one of its legs in such a manner that a metal hook in the frog's back touches a silver disc, the other leg, however, falls freely upon the same disc, its muscles contract violently as soon as the leg touches the silver surface. Consequently the leg rises, as shown in Fig. 1, but falls down almost immediately, whereupon it comes again in contact with the silver, contracts for the second time and thus continues to rise and fall to the astonishment and pleasure of the scientist."

Galvani thinks the entire muscle is nothing but a number of Leyden jars.

Referring to Fig. 1, if this experiment is to be made, kill a frog, skin it quickly, cut it with a large pair of scissors in the middle of the body and expose the two thigh-nerves which appear as two thick, white threads. These, together with one of the legs are now touched with a hoop made of a copper and zinc wire, twisted around each other as shown in illustration. As soon as touched the muscles contract violently, as if the frog were still alive. Thirty minutes after the frog has been killed the contractions become weaker and weaker and soon after stop altogether.

Swammerdam, who made above experiment already in 1678, thinks that

\* Translation: "Explanation of electrical forces through movements of muscles."

† Galvani, Luigi, born 1737, died 1789, Professor of Medicine, Bologna, Italy.

several causes act together to produce the result. Volta, however, thinks quite correctly that the connected metals, zinc and copper, when touching the moist flesh and the nerves, form thereby a galvanic cell, or an electric battery.\*

Another, but simpler physiologic experiment, is the following: Place a silver spoon handle under the tongue

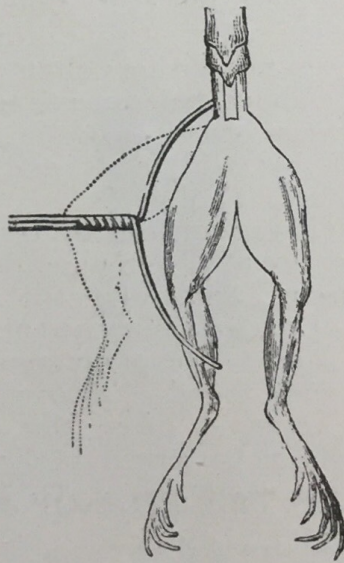

Fig. 1

and on top of the tongue a piece of zinc or iron sheet. As soon as the two metals are touched outside of the mouth, one tastes an electric current and at the same time one has the peculiar sensation of a contracting taste, which is produced by the decomposition of the saliva in the mouth and the desintegration of the zinc. If one changes the two metals around, the taste will be sour. This was first observed by T. George Sulzer (1720-1779), of Berlin.

\* Electric, from elektron, i. e., Amber as on this substance similar phenomena were first observed. The word "electricity" was first used by Robert Boyle in 1675.

He who has a gold tooth, knows that if it is touched with a piece of metal, a violent pain is experienced.

If one places a wet piece of zinc on one of the closed eyelids, and if a piece of copper strip is placed in the mouth, one experiences a sensation of light in the closed eye, when the two metals are touched with each other. Every

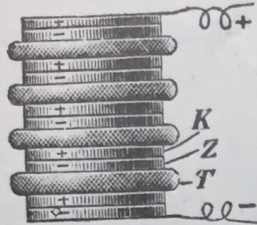

Fig. 2

time the metals are touched it seems as if it was lightning before the eye.

Upon a fifty cent piece place a cent piece and on top of this place a leech. The leech tries to get down on the fifty cent piece, but every time it comes in contact with it, it draws back quickly, no matter how often it tries.

All the above experiments are simple applications of the galvanic current, produced by two metals, and a liquid or moisture.

Galvani was misled by concentrating his entire attention upon the nerves and muscles, but Volta, the real discoverer of the galvanic current, tried to find the cause of the production of electricity and thereby discovered the electric battery. From this, all galvanic cells or batteries are derived.

## 2. VOLTA'S PILE OF 1800.\*

It is constructed of round or square discs of zinc and copper, about 4 inches in diameter. They are stacked on top of each other in such a manner that each pair of plates is separated by means of a piece of cloth or cardboard soaked in salt water, vinegar or diluted sulphuric acid. Fig. 2.

The arrangement is the following: zinc, copper, cloth; zinc, copper, cloth, etc. This battery cannot be built up too high as the weight of the plates presses the liquid out of the cloth pieces which greatly reduces the current strength. When this battery was

\* Count Allesandro Volta was born in Como, Italy, in 1745; he was Professor of Physics in Pavia from 1779-1904 and died 1826 at Como. He invented the electrophorus, the condenser and the electric pistol. Volta and Galvani had a scientific dispute over the causes that produce electricity.

first made, silver discs instead of copper discs were used. This battery gives current only for a few minutes.

**Explanation.** A galvanic or voltaic cell is any arrangement, due to which an electric current is produced by means of chemical or physical forces (for example, Diffusion\*). It does not make any difference whether the occurrence takes place between a solid body or a liquid or between two liquids, or even between two gases.

## 3. WOLLASTON BATTERY OF 1815.†)

Fig 3. shows this battery. In the center is a zinc plate ( $-Zn$ ) about 3 inches wide and 8 inches high; around the zinc plate is placed a U-shaped foil of copper ( $+Cu$ ) held in place as shown. The elements are held together by rubber bands, while small wood-blocks keep them from touching each other. This battery loses its current quickly. Humphry Davy, the inventor, of the arc light, by using 2,000 of Wollaston batteries in 1808, made his famous experiments of the voltaic arc, formed between two pointed carbons.

## 4. PULVERMACHER CHAIN.

High electric tension can be produced quickly by means of the Pulvermacher chain. On round wooden sticks, about the thickness of a lead pencil, wind two wires running parallel to each other, but in such a way that

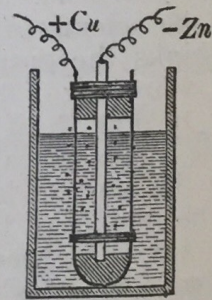

Fig. 3

they do not touch. One is gilt copper wire, the other a heavy zinc wire.

The copper wire ends at one side, the zinc wire at the other side. Each end forms a loop as illustrated, into which hooks the opposite wire of the second stick, in such a manner that each hook and eye is composed of a copper and zinc wire. 60-120 such sticks are hooked together and the ends of the first and of the last stick are

\* Diffusion, of the Latin: Diffundere—flowing through.  
†Wollaston, William-Hyde, physician, 1766-1828; one of the founders of the chemical theory of the galvanic battery.

fastened to metal rods K and Z, which have a hook in the middle.

This chain is placed for a short time in vinegar and is then suspended on horizontal glass rods by means of the hooks. The sticks absorb sufficient acid, to serve as conductor between the wires. By connecting one wire of the chain with an electroscope, the gold-leaves separate, showing the high tension current. If one uses magnesium wire instead of the zinc wire, plain water instead of vinegar may be used quite successfully.

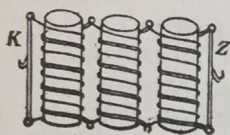

Fig. 4

**COKE BATTERY.**

A simple battery which can be made at little cost and which gives fairly good service for short time work can be made as follows: In a glass jar place a flat spiral of heavy copper wire and over the raising vertical wire shove a glass tube or a tight-fitting rubber tube, to insulate\* the wire. Then fill the jar 1/4 full with pieces of coke. Now make a zinc cylinder and suspend same from jar by means of three pieces of stiff wire as shown, taking care that the zinc does not touch the coke. Fill the jar with a solution of cooking salt or diluted sulphuric acid (acid, 1 part, water, 20 parts), or better with a mixture made of 100 parts of bichromate of potash, 50 parts sulphuric acid and 1,000 parts water.

On one side of the zinc cylinder a copper wire is soldered and the connection painted with a heavy lead paint or asphaltum. Fig. 5.

**EXPLANATIONS.**

If the copper and zinc of a battery are connected with each other, we say the battery is **closed**, Fig. 6. Unconnected, the battery is **open**. As the coke battery uses up zinc when open, it is necessary to lift the zinc element out of the solution when battery is not in use.

The solutions in the battery, which are decomposed, are **electrolytes**. The phenomenon of the separation of chemical combinations with the employment of the electric current or an electrical discharge is called **electrolysis**.

\* Insulate, from the Italian isola—*island*; to insulate—*separating*.

**6. CONTAINERS FOR BATTERIES.**

Besides glass or porcelain jars for batteries, one may use ordinary flower-pots which may be made waterproof by soaking the pots in hot paraffine. Card-board, if well glued and boiled in paraffine, makes fine battery containers, which are quite cheap.

Paper is now the style since from it are manufactured bottles, wheels, furniture and even houses, why not battery containers? A fine cement that is waterproof is made of a watery solution of bichromate of potash and strong glue. This cement must be kept in the dark as it becomes insoluble in the light.

To make containers proceed as follows: over a wooden mandril place a layer of strong paper and cover it all over with above cement; over this place again a layer of paper and so on until the container is of suitable thickness. Dry the finished article in the

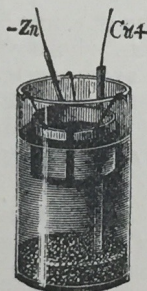

Fig. 5

sun and place for a few minutes in boiling paraffine or in marine glue. Such containers are acid proof.

To make marine glue proceed as follows: Dissolve pieces of soft rubber in 12 parts benzine, and 20 parts powdered shellac; heat carefully in a waterbath and use the glue with a regular brush.

**7. PROOF OF CURRENT.**

We have shown in the the first part of this chapter how one can prove the existence of a galvanic current by means of the taste and sight. A simpler manner is the action at a distance from the source of the current. If, according to Oersted\* (1820) one holds the closing wire of a battery over a suspended compass needle, Fig. 6, the same will

\*Oersted, 1777-1851, Professor of Physics and Chemistry in Copenhagen.

deviate from its original north-south direction. Such an apparatus is called Galvanoscope. If the battery is closed and one places it over a sensitive compass needle, the deviation will show that also in the inside of the battery a current is flowing, and always from zinc to copper.

This experiment is best made with a battery shown in Fig. 7. This is nothing but a lamp chimney and two

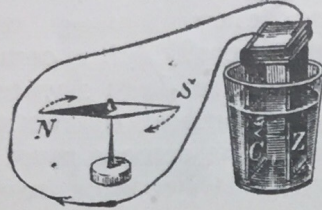

Fig. 6

plates, one of zinc and one of copper, soldered on brass rods which slide through the corks as shown.

The metal discs are submerged by diluted sulphuric acid.

A sort of galvanoscope but with stationary magnets and movable electrodes forms the floating battery of De la Rive\* Fig. 7a., whereby the zinc and copper plates are inserted in a cork which floats on acidulated water. A magnet N will turn the float.

### 8. AMALGAMATION OF THE ZINC.

Sturgeon in 1826 discovered that he could obtain a more constant current from certain batteries by using chemically pure zinc.

Such zinc, however, is quite expensive, and one therefore uses a con-

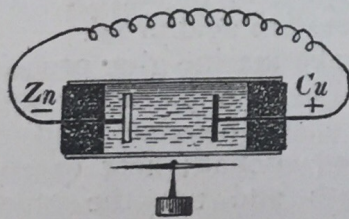

Fig. 7

venient substitute, namely one covers it with mercury,—one amalgamates it.

To do this, one places the zinc into a weak solution of muriatic or sulphuric acid; if the surface of the metal is very clean one can place it in a soup plate which contains a little mercury and diluted sulphuric acid. Then the mercury is rubbed over the zinc by means of a stick covered with cloth; the mercury must be rubbed

over the zinc till the latter becomes as white as silver. The superfluous mercury drips off within 1-2 hours.

Another method is to place the clean, pickled zinc into a concentrated solution of sulphate of mercury.

Or one dissolves 20 parts of mercury in 100 parts of aqua regia (25 parts nitric acid and 75 parts muriatic acid) by heating the solution with great care; after the mercury has dissolved add under constant stirring 100 parts muriatic acid. The parts to be amalgamated, whether plates or rods, are dipped for a few seconds into the solution which amalgamates them. After this the pieces are washed off.

The quicksilver does not affect the working of the zinc; it gradually leaves the zinc and falls to the bottom

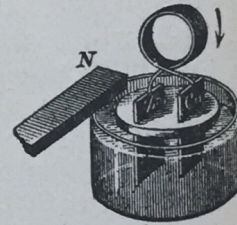

Fig. 7a

of the battery jar where it may be collected and used over again.

To amalgamate iron, dip it first in molten zinc or tin.

### ARMY TO USE WIRELESS.

The War Department of the Government is to use wireless telegraphy to communicate between army stations in the West. Orders were received at the headquarters Department of the Missouri to cease sending army telegrams by commercial telegraph lines and to make use of the wireless system which has been installed at Omaha and in Fort Leavenworth and Fort Riley, Kan.

Stations also are being installed in the army posts in Cheyenne, Denver, and other Western points. There is a large volume of telegraphic communication between headquarters at Omaha and the army posts, particularly those in Kansas. For that reason Fort Leavenworth and Fort Riley were equipped immediately after the central station here. The Fort Omaha station, which was the first erected, has been furnished with the very latest equipment.

\* De la Rive, 1801-1873, Physicist of Geneva.



# Radioscope

By A. C. Marlowe.

(Paris Correspondent Modern Electrics)

**O**WING to the increasing work with radium and different radio-active substances, the need has been felt for a convenient means of measuring the activity of substances which are examined. Such measurements often

being very light. Around the needle is a metal frame R electrically connected to the needle, while both are well insulated from the box. To block the needle, a rod D is inserted through the tube T which is insulated from the box. The same rod is used to bring an electric charge to the needle from the outside.

The measurement consists in observing the natural fall of the needle away from zero when charged, owing to its slow discharge. We then observe the rate of fall when using a standard radio-active substance placed in the box. To begin with, we place the apparatus so that the magnetic needle, when pointing north-south, comes on the zero line; as shown by the scale on the glass cover of the box. We then place the rod D so that it touches the needle and then give an electric charge to the needle. This is done by rubbing a piece

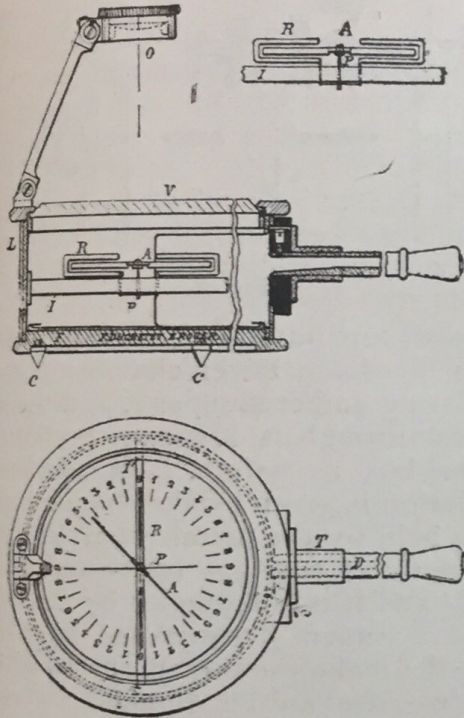
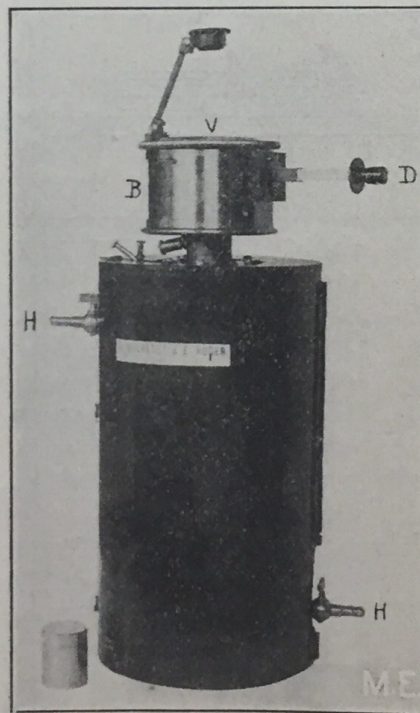

Fig. 1

need to be made outside the laboratory, as when observing minerals, soils, residues of mineral springs, mineral water or the atmosphere, this work often needs to be done on the spot. An instrument known as Radioscope is devised for the purpose by Prof. Szilard, a well-known worker in this field and connected with Mme. Curie's laboratory at the Paris University. It is constructed at the Ducretet establishment and will be convenient for chemists, mineralogists, geological workers, doctors, etc. Measurements can now be made much more easily than before. The method consists in charging a movable system and then discharging it by the conductivity which the air takes under the action of the radium rays. A metal box B (Fig. 1.) carries an insulating piece I in which is mounted a pivot point P carrying a magnetized needle A, this



General View of Radioscope

of amber and touching the outside end of the rod so that the rod and also the needle become charged. Then we remove the rod by holding the insulating handle. Owing to the effect of the charge, the needle now takes a certain angle from the first or zero position.

However, the charge does not hold up, but the needle commences to drop back, owing to the natural discharge. We observe the time taken by the needle to drop by one degree, calling this F. A disc covered with standard radio-active substance such as uranium oxide is put in the box by unscrewing the bottom and then closing again. The action of the rays is such that the electric discharge is now more rapid, owing to the well-known effect of such rays upon the air. We again observe the time taken by the needle to drop by one degree and call this time E. Next we put in a second disc (in place of the first) which is covered by the test substance, and we have a new rate of drop, calling this S. The activity of the substance in relation to the standard or unity, is  $\frac{(F-S) E}{(F-E) S}$

Seeing that different kinds of rays are given off by radium and like substances, it is best in some cases to use a large chamber below the needle box so as to allow the substances to act upon the air in the best way. To do this

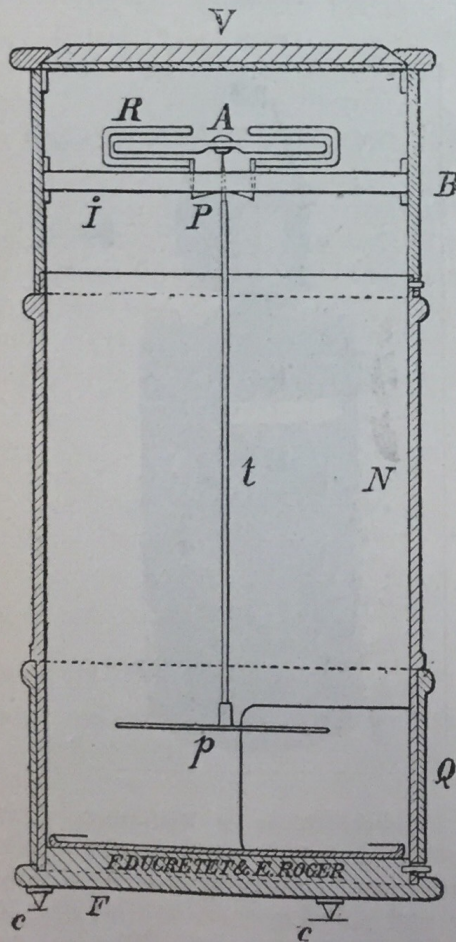

Fig. 2

we unscrew the bottom of the box and replace it by the long cylinder N,

(Fig. 2) putting the test discs on the bottom as before. The rod t runs from the pivot to the aluminum plate p. In this case the effect of the rays takes place in the cylinder and is exerted between the bottom disc and the plate P. Another form is shown in Fig. 3, which

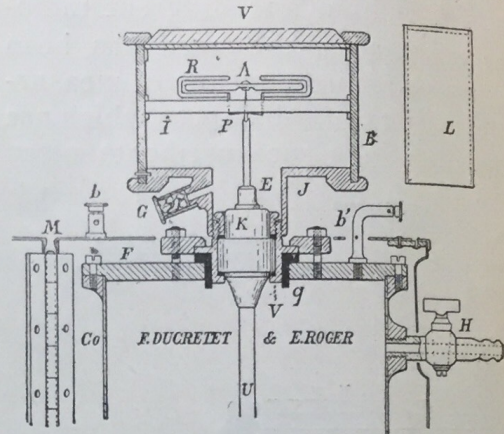

Fig. 3

is used for liquids and gases. The cover F of the lower chamber has an insulating amber stopper K and the rod passes through it down to the bottom of the box as before. An additional insulation is given by the ebonite bushing q held by the metal collar V. The cylinder has two gas inlets and cocks H, H<sup>1</sup> and it is surrounded by a second metal cylinder M, insulated from the first. To make the measurement with a gas, we use an air pump to give a fairly good vacuum and then let in the gas, then allowing air to enter until the pressure becomes equal. The readings should be made about 3 hours after putting in the gas. For the standard, there is used a gaseous body instead of a solid as before, this being radium emanation, and it is introduced into the box as we have just shown.

**A GREEN WRAPPER**  
means your subscription expired. Better renew to-day and you won't miss important numbers.

**W. A. O. A.**



The Wireless Association of America, headed by America's foremost wireless men, has only one purpose: the advancement of "wireless." If you are not a member as yet, do not fail to read the announcement in this issue. *No fees to be paid.*

# Method For Winding a Secondary Coil

By F. R. Gaston, Asso. Professor of Physics, State Normal College, Ypsilanti, Mich.

In setting up a spark coil it is advisable to wind the secondary in thin sections. In order to do this neatly and rapidly, it is necessary to secure well-made apparatus that can be revolved in a lathe or by the help of some small source of power, as a sewing machine or small motor.

Let us suppose that each section is to have a 2-inch opening and an outside diameter of  $3\frac{1}{2}$  or 4 inches and a thickness of  $\frac{1}{4}$  inch. A  $4\frac{1}{2}$ -inch bolt is first procured  $\frac{3}{4}$  in. in diameter (AA, Fig. 1). This is centered in a lathe and a center hole drilled in each end. From a  $\frac{3}{4}$ -in. pipe turn off two pieces about  $\frac{5}{8}$  in. long for BB. From a plumber obtain a short piece of 2-in. brass tubing and turn off a piece CC  $\frac{3}{4}$  in. long with true ends and smooth edges. Next, turn out of hard pine  $\frac{7}{8}$  in. thick two disks DD about 5 in. in diameter. While each block is in the lathe turn a depression FF  $\frac{1}{4}$  in. in depth and perfectly smooth into which the brass ring CC will fit well. Also groove the rim of one for a belt as shown at EE, and turn the centers out to receive the bolt AA. Now put the

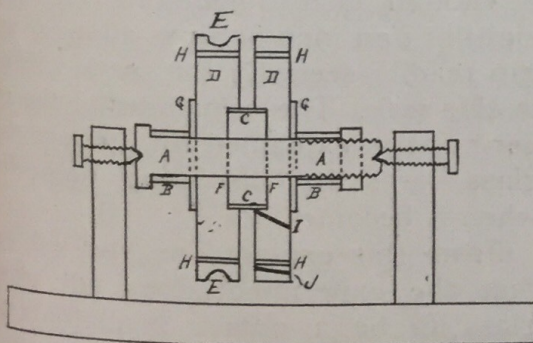

Fig. 1

various pieces together as shown, using the large washers GG to prevent warping. Four holes should be drilled near the edges of the disks to receive  $2\frac{1}{2}$ -in. stove bolts, and small holes I and J for the ends of the wire.

To wind a section of a coil, first coat the surface of the brass tube with paraffine, set the apparatus in a lathe, and "fish" the end of the wire through the

hole I. Place the spool of wire on a smooth spindle and start an even layer of wire on the paraffined ring, always running the winding device from you. After the first layer has been wound, the lathe may be run at a high rate of speed and the wire will wind in a remarkably smooth manner. It is surprising to note how quickly a fine section can be made if the apparatus is well-constructed. When the proper diameter is secured, bring the end of

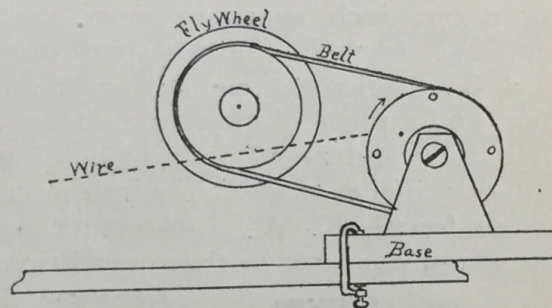

Fig. 2

the wire through hole J and then set the four stove bolts in the holes HH. The center bolt may now be removed and the coil placed in hot paraffine and thoroughly saturated. After removing the disks from the paraffine and cooling, the bolts may be removed. A slight tapping upon the disks will serve to loosen the flat section of wire and the brass ring will easily slip out.

It is advisable to give each section a good coating of paraffine over the sides to hold the wires in place. To do this, distribute small pieces of the wax about the section and then melt it into an even, transparent layer by carefully "ironing" it with the face of a heated hammer.

If it is desired to unwind the wire, clamp the section firmly between the winding disks and mount the device as shown in Fig. 1. By placing a spool in the lathe, the wire can be quickly transferred, as the coating of paraffine will prevent it from drawing down between the disks and the coil. By holding the section on two fingers, the wire can be unwound from the inside without loss.

# A Novel Experiment With Glass

Philip Edelman.

IF I were to ask "What material is the best insulator," the answer would probably be "glass." Perhaps some wiser ones might say, "mica." In either case, the following experiment apparently shows that these "best" insulators are poorer insulators than common dry air, or better conductors than common dry air. Yet dry air is considered a poor insulator, or fair high tension conductor, whichever you wish.

The apparatus necessary is a coil giving a one inch spark or more, large condenser for bringing this spark down to a fat discharge one sixteenth inch long, and a piece of glass one sixteenth inch thick and about four inches long and two inches wide. A wireless coil or one-fourth K. W. transformer will just about conform to these conditions.

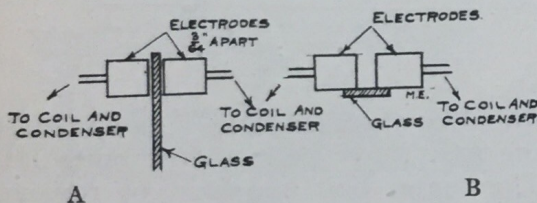

Adjust the spark gap so that the spark will just barely not jump across. This will be just a trifle more than one sixteenth inch if the spark only jumps one sixteenth inch. Now insert the glass into the air gap between the two spark electrodes. Instantly a discharge leaps across. The primary current is left on during the whole experiment. It is not long before this discharge takes the form of an arc. Now push the glass in further. The discharge will follow around the edge of the glass, and can be drawn out to several times its original length in this manner. By this time the discharge will have heated up the glass and will break then, starting at the edge. If you push the glass further into the gap, the spark will cut a line thru it. After the spark has cut its way thru about one inch of the glass, the glass will usually crack. If a sheet of mica is used it acts much the same way.

Two things must be considered in explaining this action. These are the dielectric strength and the inductive capacity of the glass, mica, and air. Glass has about twenty times the dielectric strength of air, and mica about one hundred and twenty times. On the other hand glass has only about six times and mica about five and one half times as great inductive capacity as the air. Also another important factor is the heat generated in the glass or mica, when it is subjected to this high tension. Now, in the experiment just described the discharge divides itself inversely according to the inductive capacity. This means that if the gap is composed of air for about one sixty-fourth of an inch and glass for one sixteenth of an inch, only four-sixths of the total penetrating strength of discharge is spent in penetrating the glass, leaving one third of this penetrating strength to pierce only one sixty-fourth of an inch. Since this one sixty-fourth inch gap is only one fourth of the gap normally pierced by this discharge, and one third of the penetrating strength of the discharge, or enough push to penetrate one forty-eighth of an inch of air is allowed, you can readily see why the spark will act in this way. The remainder of the experiment is explained by the fact that glass loses its insulating properties when it becomes hot.

From this explanation, you will see that the experiment **does not** prove glass to be a poorer insulator than was at first thought. If the glass is applied to the gap as shown at, B, in the figure, the discharge will jump the lengthened gap in the same way. The spark makes a greatly increased noise. I thought this lengthened spark might increase the radiation in wireless sending, but found that it acted the same as when the spark arced, i. e. the oscillations were not set up in the shunt circuit, so that there was very little radiation.

# Duplex Fire Alarms

By Raymond W. Woodward.

**B**OTH of the burglar alarm systems that are in common use have unavoidable faults. The open circuit system can be rendered useless by merely cutting the wires, while by crossing the wires of a closed circuit system that is also useless. However, there is a way to overcome both of these difficulties.

Fig. 1 shows a system which is not absolutely fool-proof, but which is nearly so. R is a 20 ohm relay connected to the ground on one side and to gravity cells and a resistance on the other. From the battery a wire runs to the place to be protected as shown at C.

The local circuit is formed by a bell and two or three dry cells. The side of the bell not connected to the battery is fastened to another wire leading to the protected quarters, shown at a. One side of the dry cells is grounded, as is also the wire b, a and b are led to open circuit trips, and b and c to closed circuit ones. The wires should be twisted together and of the same color and concealed, if possible, so that they can not be followed.

In Fig. 2 is shown an absolutely fool-proof system. In this case two twenty ohm relays are needed. They are connected in series with gravity cells G C and a resistance O of 100 or more ohms. The two wires should

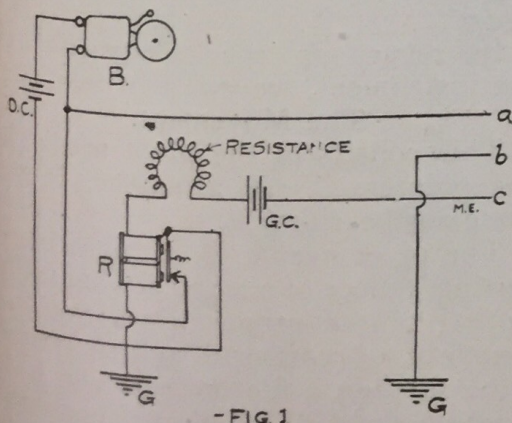

- FIG. 1

be led together and the coil placed at the end as in the diagram. The closed-circuit trips CC are connected in series, while the open circuit ones are in parallel. One of the relays R is ad-

justed (by the spring) so that it is normally attracted and away from the

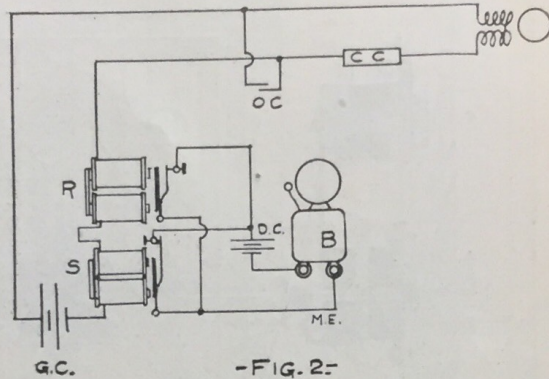

- FIG. 2 -

contact point. When a closed circuit trip is touched or the wires cut, the armature will fly back and make a contact and give alarm. The other relay S is adjusted so that it is normally away from the magnet and contact, which in this case must be reversed. When an open circuit trip is touched or the wires crossed, in other words, the resistance coil cut out, the armature will be attracted and make contact, because of the stronger current. The wiring for the local circuit is given in the diagram.

The latter system is excellent for protecting a wireless station that is situated at a distance from the owner's place of residence, as the wires do not need to be concealed.

## Neon Tubes for Lighting.

Some interesting experiments were made with Moore tubes by M. Georges Claude, of Paris. He wished to find out what were the best gases to use in the tube so that the glow will be the best in the rarefied state. Using some of the rare gases, he found that neon gave a very brilliant light of a yellow color, so that it was well suited for ordinary lighting. He presented his results to the Académie des Sciences, and showed that the effect would not be produced except when special precautions were taken to exclude all traces of other gases, for should these be present the tube will not work. Such tubes may come into use for practical purposes before long.

# A Polarity Indicator

By G. E. Rudolph, E. E.

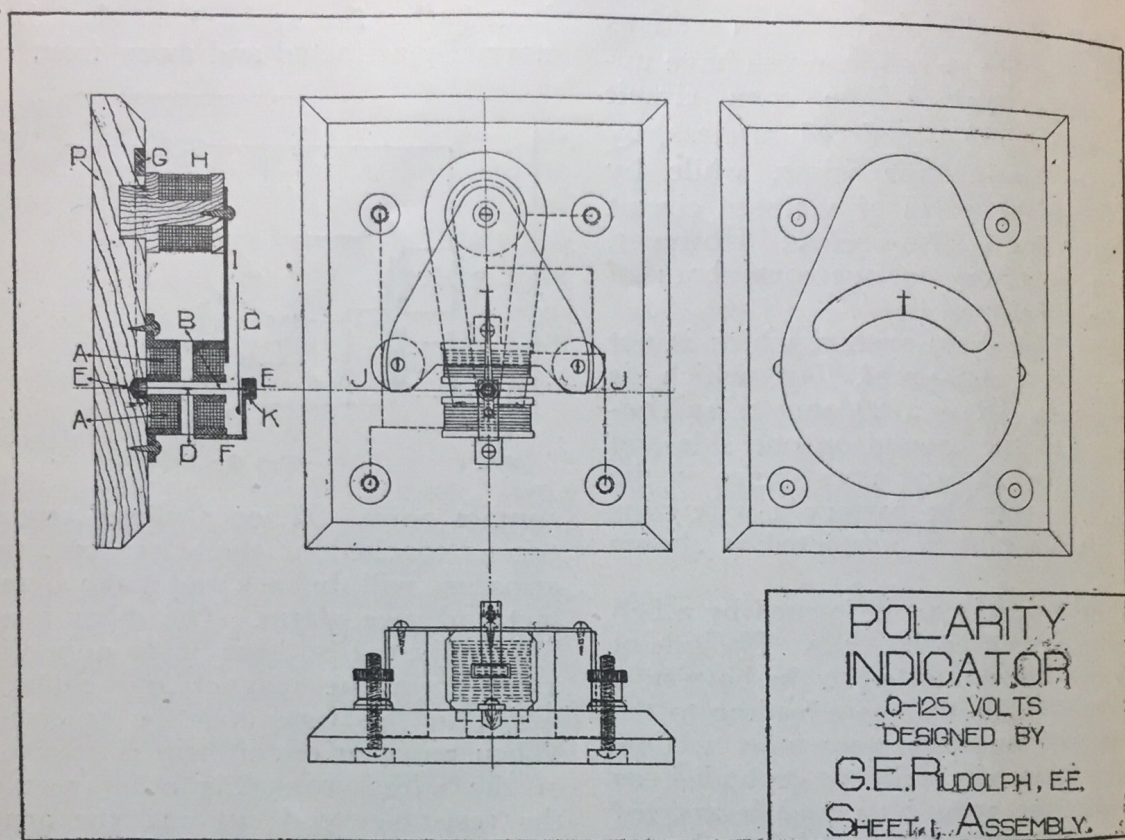

**B**EING in need of a polarity indicator for some time, and not finding satisfaction in pole-testing paper and such material, the writer decided to design one, and was rewarded with very gratifying results. In fact, it is so simple as to allow its being made by any amateur at home with only ordinary tools. And he, no doubt, will find it an easy and enjoyable undertaking, and will have, (if the following remarks, along with the drawings are carefully followed), a very efficient and handy little instrument that has a wide range of usefulness; as the resistance coil of german silver wire will allow its being used on any voltage up to 125 without undue heating, providing it is not left in the circuit too long.

The accompanying drawings are self-explanatory, but a few remarks may not come amiss to those wishing to make an indicator for themselves.

In the assembly drawing two sets of binding posts will be noticed; the lower two being for low voltage, such as ordinary battery voltage, and the upper two for higher voltage, such as the

house-lighting circuit, dynamos, etc. In either case, the binding posts are so connected that the pointer indicates the side to which the positive wire is connected, when testing a circuit. A note on the dial mentioning this fact is advisable as it makes the instrument more business-like, as well as explaining its action to any one wishing to use it.

In regard to the construction of the instrument, we will first take up—

### The Movement.

This consists of the pivot needle, B, the pointer, C, the armature, D, and the glass bearings, E.

The pivot needle, B, is made by inserting a piece of a small sewing needle or hat pin of proper length into the clutch of a breast-drill, and sharpening it by holding a file on each end while rotating the drill. Follow this up with a whet-stone to make it smooth, so as to turn in the glass bearings with practically no friction. The drill may be used in the same manner as shown in previous issues of "Modern Electrics" for winding electro-magnets.

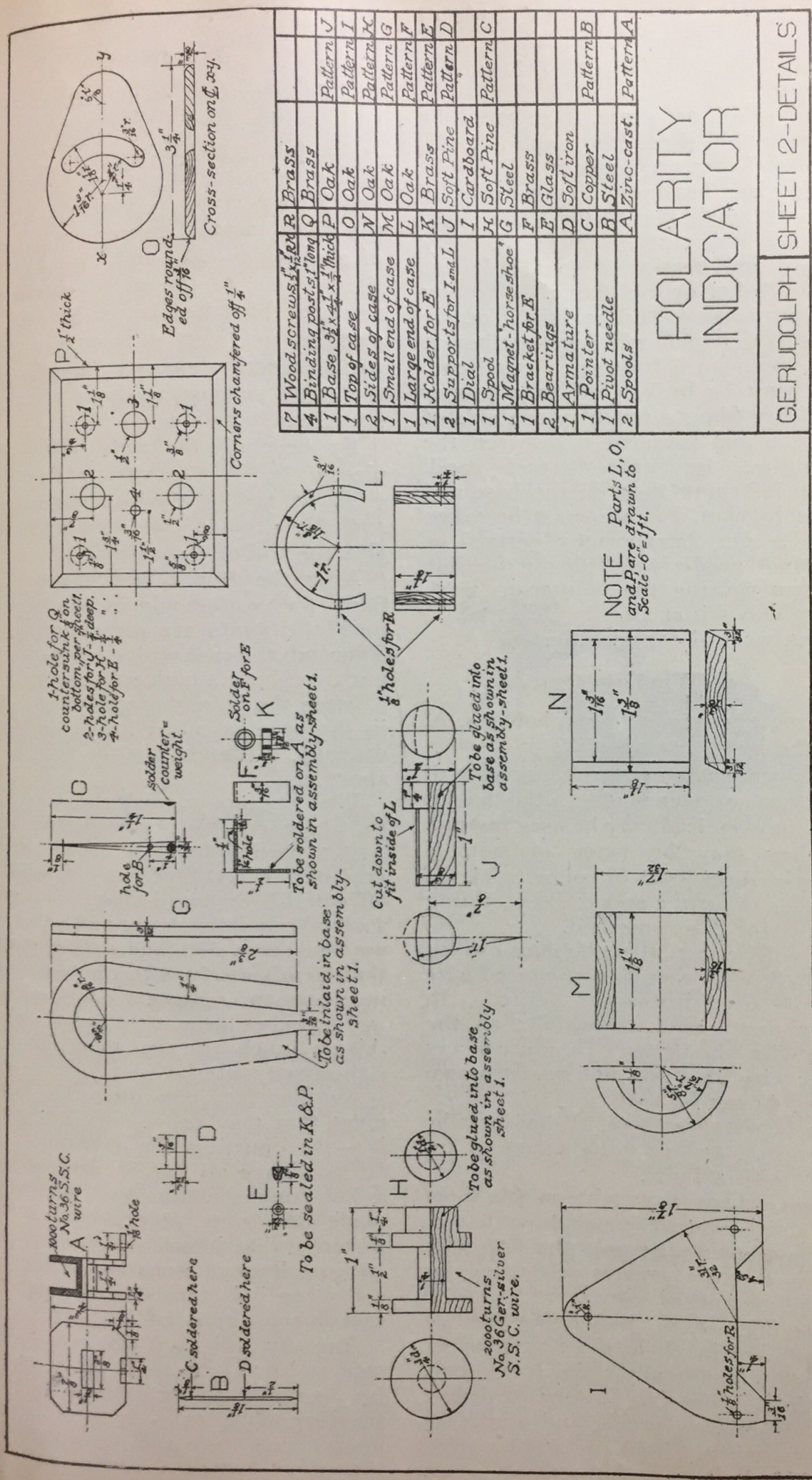

# POLARITY INDICATOR

GERUDOLPH SHEET 2-DETAILS

The pointer, C, should be made of thin-beaten copper, the thinner, the better. This beating also makes it springy.

The small armature, D, should be cut from thin sheet iron, such as ordinary "tin" cans are made of.

The glass bearings, E, are made by taking a small glass tube, (the small end of a medicine dropper does very nicely), and heating it to a red heat in an alcohol or gas flame. Then by slowly turning it and holding it nearly vertical, the tube will run together at the bottom until it forms a small cup. This may be broken off to a proper length by filing a notch in one side of the tube and pressing it between the thumb and forefinger of each hand. When fastening them in the base and in the bracket, F, care must be taken so as to get them exactly vertical or the pivot needle will rub on the side of them causing the pointer to work "sluggishly," if at all.

Next we will consider the

### Windings.

These consist of the two bobbins, A, and the resistance spool, H.

The magnet bobbins, A, are cast of zinc in a wooden mold; altho babbitt metal or even lead may be used instead. Or they may be made of suitable pieces of sheet-brass or copper soldered together to form a spool; altho casting them is the easier method.

As will be seen, these bobbins call for No. 36 S. S. C. wire; but enameled wire may be used instead if desired. In either case, wind them full; as the more wire, the better. Do not use any larger wire than this, but smaller down to No. 40 can be used.

The resistance spool, H, had best be turned out, as it is quite a task to cut it out with a knife.

The German silver wire on this spool may also be varied in size down to No. 40. In any case use only the 30% wire as this has the greater resistance for a given amount of wire.

The magnet, G, had better not be varied very much in size; as a larger magnet will not allow the feeble current from a one-cell battery to deflect the pointer very much, and a smaller magnet will not hold the pointer from vibrating back and forth during a test.

Now let us consider the

### Woodwork.

This consists of the two circular ends of the case, L and M, the sides, N, the top O, and the base, P.

The two circular ends of the case, L and M, are made by boring a hole of the given **inside** diameter into the **end** of a piece of oak; and then dressing them down to the given **outside** diameter. This had better be done on a lathe too; but of course a little patience with a sharp knife will serve the same purpose to those who have no access to a lathe.

By beveling the ends of the side pieces, N, of the case carefully, a good fit can be made between them and the circular ends, by glueing as also the top of the case O.

After the glue is perfectly dry and hard, the case should be sandpapered until the joints are perfectly smooth. Then rub the case with a piece of wood until you have a high polish on it.

After the holes have all been bored in the base as called for in the detail drawing, it should also be finished as above.

Then stain or varnish the woodwork to whatever shade you desire. The writer used Johnson's brown weathered-oak Wood-Dye, and finished it off with his Prepared Wax. This gives a very beautiful velvety finish that will not show scratches, and a shade of stain that blends nicely with the brass binding posts and screws.

Use only the quarter-sawed oak as this is much prettier than the plain slab-sawed material.

Another fact regarding this instrument that may prove very interesting is:—By omitting the resistance coil, H, you have all that is necessary for a low-reading voltmeter. The writer made one some time ago that is so sensitive that it will show the gradual fall in voltage of a nearly-worn-out dry cell when it is furnishing enough current to cause this fall.

And by substituting heavy wire, (about No. 12 or 14 B. & S. gauge), for the No. 36 on the bobbins, A, a very sensitive ammeter is the result. These instruments have the advantage over the usual home-made ones by being



portable; i. e., they may be used in any position without altering the reading any.

Of course, in making either a voltmeter or an ammeter of this instrument, a different form of case would be required, as this case does not allow for enough movement of the pointer. And the pointer would also need to be turned on the pivot so as to rest at the left side of the scale when not in use.

### PRESCRIPTION BY WIRELESS SAVES LIFE.

**A** WIRELESS message flashed 800 miles, from steamship to steamship, from the coast of Florida to the coast of Yucatan, saved the life of Capt. Arthur N. McGray, master of the tramp steamer Herman Frasch of New York, when he lay at death's door from ptomaine poisoning, last month. Then the captain, in his usual health, brought his vessel to this port.

On Jan. 2, when the Frasch left the Gulf port Sabine Pass, Capt. McGray, was taken ill after eating canned salmon. There was no surgeon on board the Frasch and he grew steadily worse. On Jan. 4 he realized that he was near death. As he lay writhing in agony in his bunk it occurred to him that he could send a wireless message to the physicians of the United States Naval Station at Dry Tortugas, which was then about 100 miles away.

Eight times that distance away the Ward line steamship Merida was leaving the harbor of Progreso, Yucatan, when her wireless operator caught the message telling of the illness of Capt. McGray, and asking rules, for treatment and a prescription. The surgeon of the Merida wrote an answer. It was received on board the Frasch an hour before the naval surgeon at Dry Tortugas replied.

Capt. McGray believes the prompt intervention of the message by the operator of the Merida saved his life. "An hour more and I would have been on the wrong side of the crisis," he says.

### TELE-MICROPHONOGRAPH.

In order to work a phonograph in connection with a loud-speaking telephone, the Ducretet firm of Paris, have designed the following instrument known as "Tele-Microphonograph." The combination of phonograph and microphone transmitter is realized here in the best manner, as the result of different experiments. The sounds given off by the phonograph diaphragm R are received by the microphone Mi and the wires are taken from here to the loud-speaking telephone which is mounted at a distance. For the loud-speaking telephones, the Gaillard-Ducretet type is adopted such as is used in the French Navy and other places for transmitting orders. This telephone will carry a heavy current and the voice can be heard at some distance off. What is to be noticed is that the microphone system is independent of

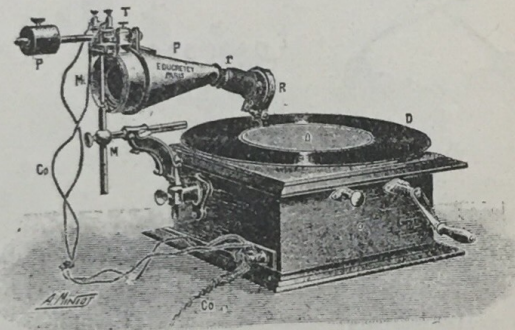

the phonograph part, so that we can obtain the best regulation of these two parts with respect to each other in order to have a good reproduction of the sound. The loud-speaking receivers can be placed at different parts of the house, garden, etc., and as they may be concealed from view, some interesting results can be obtained. The above combination does not hinder the phonograph from being used in the ordinary way, as the microphone part is easily removed and the usual mouthpiece can be put on.

### THE SOUTHERN WIRELESS

**ASS'N** was formed Dec. 12, with B. Oppenheim, Pres., and Sam Stone, Secy. and Treas. The Association has over 100 members already and those living around New Orleans are invited to join by corresponding with the president. Address 1435 Henry Clay Avenue, New Orleans, La.

## Paris Letter

### New Electrolytic Detector.

THE following method is used by M. Jegon, of Paris, for wireless posts in which hour signals are to be received. Where electrolytic detectors are used, it is well known that we need a good adjustment so as to work at the critical voltage of the detector, and this is usually done by two storage battery cells giving 4 volts, along with

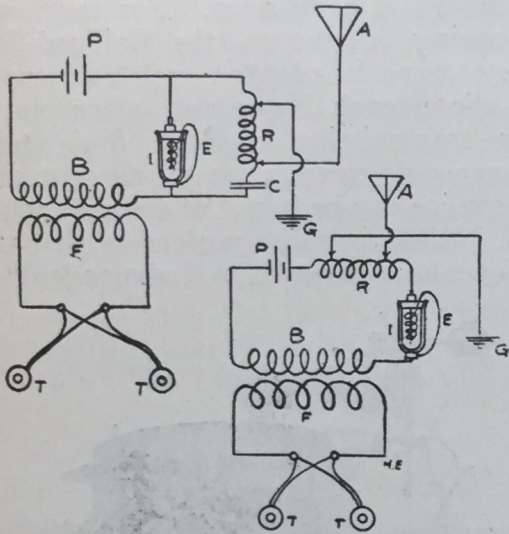

a potentiometer. While this can be done by regular wireless stations it is not convenient for independent posts which may need to receive the wireless signals, as these may lack the means for battery charging, etc. Accordingly he devised a method for using an ordinary battery so as to give a simple and compact set. He now suppresses the potentiometer and uses a detector which is designed so that its critical voltage is always somewhat above that of the battery. Another point is the use of a telephone transformer having the primary of heavy wire connected to the telephone, and a fine secondary coil in series between the battery and detector. In this way the working is improved, and we have greater sensitiveness. This is due to the fact that the potentiometer is not used. It is found that the potentiometer causes a diffusion of the waves, seeing that some of these pass by the potentiometer, and not all by the detector. Again, the telephone is not in the detector circuit, but in an induced circuit, so that the diaphragm is only attracted when the waves act on the detector, and there

can be no permanent tension on the diaphragm by the constant current of polarization of the detector. A better result is thus given. The diagram shows two Laclanché or dry cells on the detector E which is of a special form and uses an electrode of lead in the shape of a coiled fuse wire, with the usual fine wire in the middle.

Water acidulated with sulphuric acid forms the solution. This type of detector, which was lately patented by M. Jegon, has a critical point which is much above the voltage of the two cells. In series with the detector is the long fine wire coil B, about 450 ohms, with the heavy wire secondary of 3 ohms. To the secondary we connect a pair of 140 ohm telephones in parallel. The tuning coil R is joined to the ends of the detector, with the condenser C in series, or as in the second diagram, directly in series between the battery and detector, without the condenser.

### Simple Buglar Alarm.

A very simple burglar alarm can be made by using a thread stretched across the room and connected with an electric alarm device. An arrangement of the kind is shown here. The thread is fastened to a pin placed in the wall and

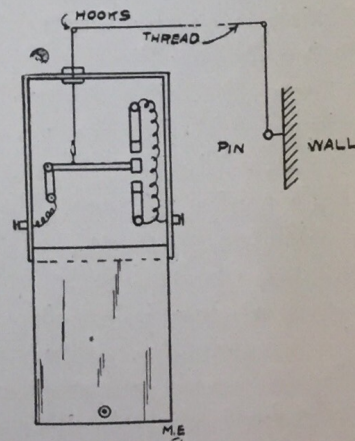

is stretched at the desired place in the room by running it over a pair of ordinary insulating hooks. It then runs into the box containing the alarm device. This consists of an arm which is pivoted at one end and is held in place in the middle position by the stretched

thread. Should the thread be broken by a person coming against it, the arm will fall and thus make contact with the lower metal piece so as to ring a bell at a distant point. If the thread is not broken, however, but simply stretched, the arm is raised and comes against the top contact, and this also makes the circuit for the alarm. A sliding cover is used on the box, and it also carries an alarm contact, so that any attempt to slide the cover off will again close the circuit. It is best to have the lead-in wires concealed in the wall and run into the back of the box, so that they cannot be cut. A pair of false wires can be run from the box, having these well in view so that they can be cut and no further search will be made for the real wires.

**New Marconi Circuit.**

The following method of coupling has been patented by the Marconi Company. Using a Fleming valve detector V, this is connected as here shown. The local detector circuit 1, 2, and the telephone circuit 3, 4 are loose coupled and are tuned to the same pitch of wave. This is claimed to give very good results for receiving circuits.

President Fallières, accompanied by a government commission, lately made a visit to the Eiffel Tower wireless plant, as the military station is now entirely installed in the under-ground quarters. They were received by Gen.

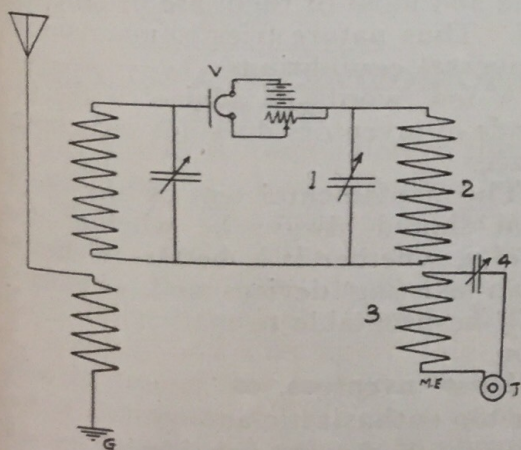

Brun, minister of war, and the chief of the wireless corps, Lieut. Col. Ferrié, Comm. Frack and others. We expect to publish some information about the new plant before long, although it is not to be inspected by visitors and is kept quite secret, owing to the fact that it is used entirely for military purposes.

**Ingenuous Selecting Device.**

We illustrate a selecting device for making certain contacts at a distance by using a vibratory method. At the sending end are mounted a number of similar apparatus I, II, III, etc. Each is composed of a vibrating tongue or tuning fork working in the usual way by an electro-magnet B. By pressing on the button A we send current into the magnet and cause a vibratory current to be sent into the line. The pitch of the current depends on the tongue

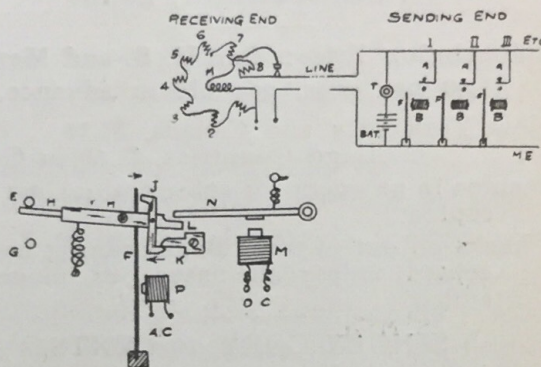

F, and each tongue is adjusted to give a different pitch. At the far end is a set of receiving electro-magnets 1 to 8, and each one works with a tongue or fork, these being tuned so that 1 corresponds with 1, 2 with 11, etc. For instance we push button No. III and at the other end No. 3 corresponds. This is shown below, where No. 3 magnet or P works with the vibrating tongue F. When it vibrates it pushes against the end of the pawl J which is held by K and releases it, allowing the arm H to fall by the spring and make contact at G. This contact can work any kind of signal, such as an electric bell or annunciator drop. A suitable device is needed for restoring, and this is done by a direct current magnet M and lever N. To bring back, we push the button T at the sending end, and this makes the circuit for the direct current magnet.

A bill has come up before the British parliament proposing that all vessels carrying over 50 passengers shall be provided with a 100-mile wireless post, otherwise a heavy fine must be paid. This does not include vessels plying between England and Ireland, where the distance is only 100 miles or so.

# MODERN ELECTRICS

A Magazine devoted entirely to the  
Electrical Arts.

Published Monthly by

**Modern Electrics Publication**

NEW YORK CITY

**H. GERNSBACK, Editor**

Subscription Price: For U. S. and Mexico  
\$1.00 per year, payable in advance.

New York City and Canada, \$1.25.  
Foreign Countries, \$1.50 in Gold.

Stamps in payment for subscriptions not accepted.

Checks on out of town Banks cannot be accepted unless the usual exchange is added.

SINGLE COPY, 10 CENTS

Forms close the 20th of the month preceding date of publication. Advertising rates on application.

The Editor will be pleased to receive original contributions of timely interest pertaining to the electrical and the affiliated arts. Articles with good drawings and clear photographs especially desired. If accepted, such articles will be paid for on publication, at regular rates.

**No manuscripts will be returned unless return postage is enclosed.**

Address all communications to:

**MODERN ELECTRICS PUBLICATION**

233 Fulton Street, New York, N. Y.

Chicago Office: 907 Manhattan Bldg.

Paris Office: 137 Rue d'Assas

Brussels Office: 23 Rue Henri Maus

Copyright, 1911, by MODERN ELECTRICS  
PUBLICATION.

Entered as second class matter March 31, 1908, at the New York Post Office, under the Act of Congress of March 3, 1879.

Vol. III

FEBRUARY

No. 11

## EDITORIAL.

**W**E have spoken several times of inventions and the present editorial is one on cultivating inventions.

Generally speaking, there are two kinds of inventing. One is achieved by the man who can't help inventing new things; he is a born inventor, just like

a musician to whom music comes naturally and who never needed a teacher. The second kind of inventing is the mechanical kind. By this is meant the kind of inventing that is done by persons to whom inventing does not come natural, but those who are suddenly confronted with a certain device that to their minds seems imperfect, whereupon they will bend their energies towards improving the existing device.

The born inventor differs from the mechanical one in that to him ideas come suddenly, without the slightest suggestion. The writer, for instance, who has invented a number of devices will suddenly have a certain idea, of which he perhaps never thought before. Within less than ten seconds after the first impression of the idea, he will see the entire device, down to the smallest detail clearly before his mental eye and from that mental picture a complicated sketch of the device can be drawn immediately without reflection or real thinking; just like copying an existing drawing.

Considered all in all, the two kinds of inventors, as far as their inventions go are nearly equally matched. The born inventor will usually invent a great many things, three fourths of which are useless: he becomes guilty of over-production. The mechanical inventor invents very few things as a rule and most of them are usually useful. Thus nature tries to maintain the universal equilibrium.

A few words of advice to the two kinds of inventors does not seem out of place.

The fundamental test of any invention should always be whether it is useful, whether it is better or cheaper than existing devices and whether it will be profitable to market the invention.

Most inventors, on account of being far too enthusiastic and optimistic, fool themselves by not considering in cold blood all the defects of their devices. There was never an invention that had not its bad points and weak spots. These should be considered most critically by the inventor, because if he does not do it, the world will soon enough do it with surprising thoroughness, usually to the dismay of the misguided inventor.

Never market an invention before it is completely worked out and "fool-proof." If it has weak spots, try and improve on same, if you don't do it, your competitors will do it for you at your expense. It is fallacious to think that as long as the device works after a fashion it should be put on the market and the improving done afterward. Nothing is more preposterous. Witness the sad fiasco of the Wireless Telephone, exploited by several American Companies, who are now defunct. One of them erected costly steel towers from 100-200 feet high in dozens of cities in this country, and the great defects of the "arc" wireless telephone must have been well known to the technical staff as well as to the promoters. Nevertheless, they plunged along, trusting to good luck that the improvements were only child's play and would find themselves. However, the improvements did not materialize in time to avert the final crash and the tall steel towers to-day are sad monuments of inventors' folly and shout their warning to inventors who would market inventions before they are ripe.

#### PHONOGRAPHS AS "CENTRALS."

The Berlin telephone department is making tests with phonographs in order to notify subscribers that the line is not free, so as to relieve the operators of this duty. The results are said to be very good.

#### WIRELESS ASSOCIATION OF ILLINOIS.

THE "Wireless Association of Illinois" was organized, Monday, January 16, 1911. The following officers were elected for a term of one year; Clarence C. Hess, President; Earl C. Bristow, Vice-President; John C. Rector, Secretary and Treasurer.

The purpose of this Association is to advance the study of Wireless transmission among the Amateurs and bring together the unknown operators of Illinois.

All persons in Illinois who own or operate a Wireless station either sending or receiving or both are invited to join. No admission fee will be charged. All who wish to join may communicate with Mr. John C. Rector, 303 N. Eighth Street, Marshall, Illinois, Secretary and Treasurer.

## Correspondence

*Editor Modern Electrics, N. Y.*

Dear Sir:— In reply to yours of the 21st. inst. and to Dr. E. F. Huth, G. M. b. H., I beg to say that in reviewing my article on "Radiotelephony in Vol. 3., No. 7., I find I do not describe the arc generators, Fig. 4 and 5, as being Poulsen arc generators.

Beginning with ¶3, Page 366, I describe Fig. 3, in detail as to how the Poulsen arc generator is constructed, and in no way, shape, or form mention Figs. 4 and 5 as being of this construction.

Through an oversight on my part, ¶1 top of page 367, should have read: Fig. 4 shows the Kuntz & Jaeger type of I. K. W. generator for producing undampened electric oscillations. The 2¶ Page 367, describes Fig. 5 in detail, which being of the same type as Fig. 4. I did not think it was necessary to mention it as being of the Kuntz & Jaeger type.

Fig. 6 is a photo of an oscillation transformer of American manufacture and not by Kuntz & Jaeger.

Fig. 7 is a photo of a Condenser of American manufacture. Dr. E. F. Huth, says my statement ¶3 top of page 368, "Fig. 10 shows the complete arrangement for employing the electric arc in radiotelephonic work as used by the writer," is untrue, as I have never sold him any such apparatus." It is true that he never sold me any such apparatus, my statement does say as used by the writer, but does not say used by the writer. As I have made tests of said type of apparatus, I felt at liberty to make the statement "as used by the writer."

As the 3 photos in question were not copyrighted photos, I used same, as my article was a review of the different systems and methods employed to produce undampened electric oscillations as used in Radiotelephony, and not a description of any one system.

Very truly yours,

WM. E. SMITH.

New York, Dec. 30, 1910.

# Construction of a Non-Heating Spark Gap

By D. E. McKisson.

**T**HE spark gap, as it is known, is a device for breaking up the secondary current of the closed oscillating circuit into a disruptive discharge, which causes vibrations in the ether, the penetration of which is dependent upon the power produced at the secondary of the transformer or coil; also upon the percentage of accuracy with which the two oscillating circuits are balanced in respect to each other.

For short distance transmission where no aerial or ground is used, two brass balls are efficient as oscillators. However, these will not produce satisfactory results on inductive systems using aerial and ground circuits, so a different type must be used. Flat faced zinc, machine steel or silver electrodes may be em-

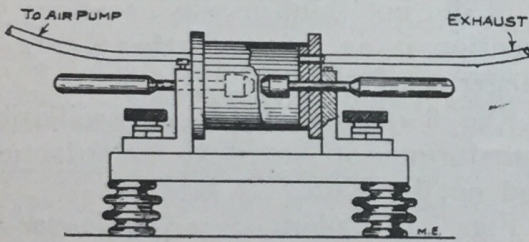

ployed with equal results. Brass is not advisable for low power sets, as its surface offers too high a resistance to the discharge. However, on high powered stations the difference is not noticeable, owing to the high amperage of the circuit. It has been found by experimentation that if both electrodes of a sustained or disruptive oscillating circuit are cooled the radiated discharge is much more penetrating. This is partially due to the fact that the hotter the electrodes the more resistance they introduce into the circuit, and, thereby, cutting down the efficiency.

The noise of the spark is one of the undesirable features of a wireless set, and in case it is necessary to cut it down or out entirely, some method must be used that will accomplish this. A few of the best known and most successful are given below. A very good plan, and one that has been adopted by several commercial stations, with good results, is to place the transformer, spark gap, helix

and anchor gap in the attic or in a small "coop" on the roof. The only noise noticed in the dispatcher's office, while transmitting is a very heavy but soft brush discharge from the points of the aerial switch. This noise is subdued in stations where there is absolutely no leakage of exceedingly high frequency currents.

Often, however, it is not possible to put the instruments in any room except in the operating room, in which case some muffler is necessary. If space is not potent, a wood "safe," constructed of heavy wood, and sound-tight, will serve admirably, and the transmitting instruments placed inside it. Again a smaller muffler can be designed on the principle of a gas engine muffler and the gap placed inside of it. Both of the foregoing methods are in use by a commercial company as mentioned previously, while the latter is used in all of their stations.

The electrodes only are placed in a sound-tight tube. The piercing detonations of the discharge are not entirely eliminated by this method, but are cut down in about the same proportions as is a rifle report by a Maxim Silencer. This method is most suitable for amateurs, owing to the low cost and comparatively easy construction. For small sets a gap made after the directions given below will prove quite satisfactory, both as to non-heating and stifling the undesired crash.

Procure a glass tube 3 inches in diameter and 4 inches long, with thick walls (micanite tubing should be used to enclose electrodes discharging condensers of over 20,000 volts). Thick rubber plugs should be turned to fit tightly in each end of the tube and holes bored in each plug; a hole in the centre for the electrode rod and a hole at one side for ventilation. On one end of the rods should be fitted the electrodes, whose faces should be bevelled to prevent the unnecessary outside sparking. Radiator discs may be used in cases where the work is continuous or the amperage abnormally high, but will not be necessary for electrodes used on the majority of amateur sets. At the opposite end of

each electrode rod should be fitted a rubber handle for adjusting. The enclosed gap, consisting of electrodes and tubes, should be secured to a rubber base by "L" shaped brass standards through which run the electrode rods. Connections with the rest of the apparatus is made by binding posts on the base of the standards. The completed gap should be mounted on corrugated rubber or porcelain insulators to prevent leakage.

The cooling element consists of a small turbine air pump, the air being passed through a rubber tube to the muffler, where it circulates and escapes with the heated air to the outer atmosphere through another tube running from a hole in the opposite side of the muffler. The air pressure should not be too strong or the air in the tube will become compressed and cut down the spark, as compressed air has a higher dielectric capacity than air at normal pressure.

### METHOD FOR WINDING A SECONDARY COIL.

(Continued from page 625)

If a lathe is not at hand for winding the sections of a coil, a sewing machine can be used as shown in Fig. 2. It is first necessary to attach a grooved pulley to the spokes of the fly wheel of the machine as shown. The winding device shown in Fig. 1 is clamped to the machine and a round belt used to connect the two grooved pulleys. The wire should be started in an even layer and held with suitable tension. To use a small motor for winding, a simple belt tightener should be made which can be controlled by the hands. This will serve to regulate the speed and also to stop the apparatus quickly when desired. The sections should be handled very carefully and the greatest pains taken to insure them against injury.

There is to be a new wireless telegraph service across the Atlantic. The stations will be at Clifden, Ireland, and Glace Bay, Nova Scotia. There will also be a service between Clifden and Coltano, Italy, putting the latter country in wireless communication with the Western world. Stations are to be established under the personal supervision of William Marconi himself. When the service is established lower rates for wireless messages are promised.

### THE LARGEST ELECTRIC CLOCK IN THE WORLD.

A NOVELTY in time pieces is now being constructed by the well-known manufacturing electricians, Gent & Co., Ltd., Faraday Works, Leicester, for the new palatial office of the Royal Liverpool Society at Liverpool, Eng. This wonderful electric clock, which will occupy a position 220 feet from the ground, possesses four dials, each measuring 25 feet in diameter or two feet more than Big Ben, while the minute hands are 14 feet long.

The mechanism is constructed on the system known as "the waiting train movement." This disconnects the time-keeping element from the hand-driving element and thus renders the clock independent of interference by wind, rain or snow, besides making it unnecessary to ascend the tower for the purpose of winding. The clock will be connected with Greenwich by C. O. P. wire. The gigantic dial is about 70 feet in circumference, whereas, the driving mechanism occupies a space barely 4 feet square.

At each beat of a pendulum the arc gets shorter in length but not duration until eventually it comes to a stop, but long before this can happen the pendulum itself automatically operates the electrical energy necessary to sustain the beats. Thus at each wide oscillation of the pendulum, one arm passes freely and completely over the notched plate below, but as soon as the shortening arc of the pendulum fails to carry it over it catches in the notches of the said plate pressing the spring lever down so that the two points of another plate below the first one came in contact. This completes an electric circuit; the coils now attract the armature with their electro magnetic energy just at the right moment to permit a clutch to catch in another clutch of the pendulum and so give it a hearty pull, repeating this continuously. The impulse transmitter is a small instrument kept in an office. It is very finely adjusted, free from atmospheric influence and capable of regulating a large number of dials, so that all record the same accurate time. As each tooth of the wheel is pulled round by an arm of the pendulum so the large wormwheel is moved slowly by a screw thus driving the hands.

# An Eighty-Foot Wireless Mast

By R. C. BODIE.

**I**NTEND, in this article, to give the details for the construction and erection of an 80 foot wireless mast, which, I think, any amateur with ordinary constructive ability can put up with very little expense, the largest item of the expenditure being for the guy wires. The pole is made up of four sections each 20 feet long, not including the necessary extra three feet

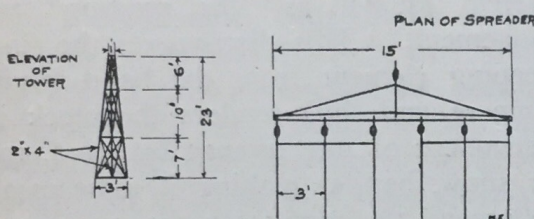

minus one and one-half at each end for splicing. The two top sections are 2x2 inches double dressed fir, the third section is 2x3 inches, and the bottom inside the tower 2x4 inches. The tower, as seen in the sketch, should be about 23 feet high and, although any kind of construction will do, it may be well to follow the ideas as shown in the drawings. It should be well guyed, for it is necessary to lean a ladder against it in order to bolt the sections at the top when in process of erection of the mast. Each of the sections, should be fitted with bolts 8x3/8 inches, but be sure the holes for the bolts are in line so that no trouble will be experienced when bolting the sections together. A good sized pulley and 160 feet of rope (or wire cable one-fourth inch in diameter) should be attached to the top of the highest section. Now as to the guys. They are as follows:

Three guys from top each 90 feet = 270 feet.

Three guys from second each 75 feet = 225 feet.

Three guys from third each 60 feet = 180 feet.

Three guys from fourth each 46 feet = 138 feet.

Total = 813 feet of No. 10 iron wire.

Insulators, as shown in the sketches, should be inserted, and all the guys laid out in position on the ground before the actual erecting is commenced. To do that, we need a single large pulley and about 50 feet of rope to fit—one-half inch being about large enough. Now attach this pulley to the top of the tower, pass the rope down through the tower and attach to the foot of the top section, the other end of the rope coming outside the tower—through the trellising—at a convenient point. Now pull up the first section until the bolts are in line with the holes prepared for them in the top of the second section, the guys having been attached and serving to keep the sections perpendicular while raising the mast. Now place the rope at the foot of the second section, pull up, bolt, attach rope to bottom of that section, pull it up, bolt and your mast, capable of receiving 1800 miles—as the writer knows by experience—with suitable instruments, is ready for the aerial. Tighten all the guys, hav-

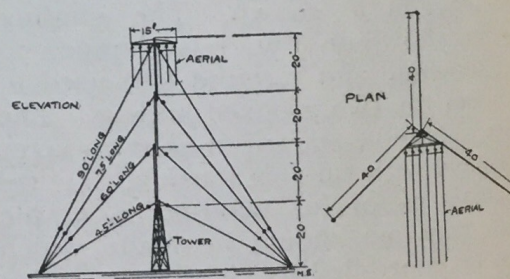

ing first seen that the mast is perpendicular. The spreaders should be 15 feet long, six wires giving a distance of three feet between each one. Insulators capable of withstanding the energy to be used are inserted about eight inches from the spreaders, which should be shaped and supported as shown in the drawings.

With such a mast erected in your backyard and an aerial 70 feet long sweeping down to your house 40 feet high, 2000 ohm phones, inductive tuner, loading coil, fixed condenser, and silicon detector, the progressive amateur should be able, at night, to hear strong stations 1500 miles away, while good work would be done by picking up some distant operator close on the 2000 mile line.



# A Hot Wire Meter

By P. W. Wormser.

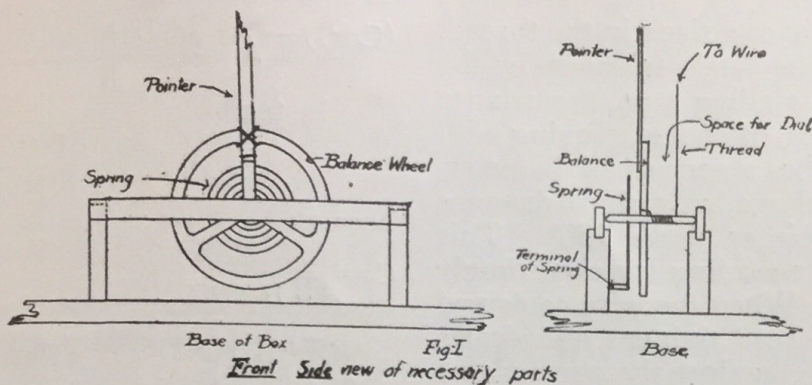

A hot wire meter is an absolute necessity if one is to realize the highest possible efficiency of his station. There are several other methods in use, the glow-lamp and anchor-gap being probably the most common, but both are unsatisfactory when the results are compared to a hot wire meter test. In fact, where the longest anchor-gap is obtained is by no means when the closed and open oscillating circuits are in resonance, for by substituting the meter one will find by entirely changing the clips and condenser capacity, a far better reading may be obtained, sometimes one 200% better being possible.

Many people have an idea that the hot wire meter is a very complicated piece of mechanism, while those who know its simplicity are deterred from making it by the high cost of jewelled bearings. The following meter if properly made will be found to be as sensitive as one costing from thirty to forty dollars, while if all the most common materials are at hand, it will not cost the maker twenty-five cents.

The first thing is to procure an old clock; a common alarm clock will do. Remove the balance wheel and hair spring, or better still, leave the necessary framework to hold it together; the rest may be cut away with a pair of heavy shears, while it will then be much easier to fasten to the meter frame (see Fig. 1).

Construct a wooden frame 7 inches long, 4½ inches high, and 2½ inches deep, and mount the balance wheel with its spring at the center of the bottom piece. (Fig. II.) Now wind up the spring by rotating the balance one or two turns. Then tie a fine silk thread to the

wheel and wind it about four times around the axle, being careful to do this in such a direction that the pressure on the spring will be balanced by pulling the thread. Now procure a piece of No. 36 bare climax wire and stretch it between the two binding posts A and B (Fig. II), but so that the direction of its length shall be directly over the point where the thread is wound about the axle.

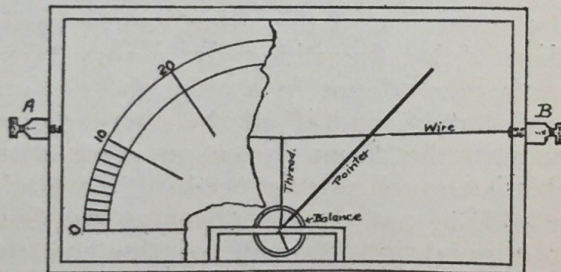

Get a piece of light, straight-grained wood (bass is good) and trim down a piece to about 1/16 inch x 1/32 inch and 3 inches long. The smaller it can be trimmed the better, as the pointer must be as light as possible. Paint it black. Pull the thread till there is a little pressure on the spring, and then fasten the pointer to one arm of the balance wheel by means of thread and a drop of wax. Be sure that the pointer is in line with the center of the wheel.

A dial must be placed back of the pointer as close as possible without interfering with its movement. As many divisions may be drawn as desired, but the greater the number the more accurate the reading. Have the center of the dial coincide with the center of the wheel.

To assemble, get the scale in position, then tie the thread to the wire at its mid-

dle point, drawing the thread with such pressure that the pointer is moved over the scale to O. The operation of the meter is simple. A current passing from A to B heats the wire. The wire lengthens and leaves a slack in the thread. This slack is immediately taken up by the spring, the axle winding it up, the balance wheel and pointer, of course, moving with it. As the axle has a very small diameter, the thread will move but a short distance to make the pointer move 180°. This gives an accurate reading for exceedingly small currents. When the wire cools and contracts, the thread tightens and draws the pointer back against the pressure of the spring to O. This is clearly shown in diagrams.

The meter will give big readings for very small sparks. If large coils or transformers are used, the wire must be shunted with several feet of No. 36 copper wire, the amount to be determined by experiment. Otherwise the heavy current would instantly burn out the high resistance wire. An easy way is to make a small, single slide tuning coil about one inch in diameter and containing about 100 feet of No. 36 D. C. C. magnet wire. The resistance of the shunt can be easily adjusted by the slide. If a very large spark is used put in a very short shunt immediately, and if all the current goes through the shunt throw on more wire. This is a much safer procedure. It would be well to put a glass cover on the box. If a good job is made of the box the meter will have a very neat appearance, but, of course, its prime value is its sensitiveness. The pointer will always return to its original position.

In order to counteract weather conditions it would be advisable to make one of the binding posts adjustable, so that the pointer may be brought back to O when the wire has expanded or contracted slightly. However, the initial reading need not be O, as the final position is what is looked for.

A very compact and sensitive meter can be made by following these directions, but using instead the hair spring of an old watch and its balance wheel. It could be placed in a case three inches square. The wire used would have to be about No. 40, as very little pull can be exerted by the hair spring to straighten it out. The pointer should be a very fine shaving of a straw stalk, held on by a bit of wax.

**ERRATA TO PUBLICATION.**

Correction of Formula used in Calculating Condensers, by I. H. Glickman, Page 501, December Issue of Modern Electrics:—

$$(Cor.)— A = \frac{36. \pi DC \times 10^5}{K}$$

instead of

$$A = \frac{36. \pi DC}{K \times 10^5} \text{ (incorrect)}$$

because

$$C = \frac{KA}{4 \pi D \times 9 \times 10^5}$$

and

$$C 4 \pi D \times 9 \times 10^5 = KA$$

Taking the formula as he has it and substituting the values for a ¼ K. W. Transformer we get the following:—

$$A = \frac{36 \pi DC}{K \times 10^5} = \frac{36 \times 3.1416 \times 2 \times .01041}{6.57 \times 10^5} = .000003584$$

Log. 36 = 1.55630		
Log. π = .49715		
Log. .2 = .30103— 1	Log. 6.57 = .81757	
Log. .01041 = .01745— 2	Log. 10 <sup>5</sup> = 5.	
	2.37193— 3	5.81757
	10. —10	
	12.37193—13	
	5.81757	
	6.55436—13 or .55436—7	

We find the best value of K for glass to be (8) instead of the value (6.57).

The formula left in the form in which he has left it will not give the correct result.

Final result checked on the slide rule to the 4th place.

EUGENE WILSON.

**TALK ACROSS THE PACIFIC.**

SAN FRANCISCO, Feb. 8.—A wireless operator in this city talked for an hour on Monday night with the operator at Chosi Shimosa, on the coast of Japan, 5,700 miles away. The messages were passed across the Pacific with one relay.

The operator got into communication with two of the Pacific Mail Company steamers—the Manchuria, which was 3,295 miles away bound from Hong Kong, and the Korea, which was on her way to this port and about 70 miles nearer. Both vessels took his message to the Japanese station, asking for the weather report at Chosi Shimosa, and both received the reply and relayed it distinctly.



This department has been started with the idea to encourage the experimenter to bring out new ideas. Every reader is welcome to contribute to this department, and new ideas will be welcomed by the Editors. WHEN SENDING IN CONTRIBUTIONS IT IS NECESSARY THAT ONLY ONE SIDE OF THE SHEET IS USED. SKETCH MUST INVARIABLY BE ON A SEPARATE SHEET NOT IN THE TEXT. The description must be as short as possible. Good sketches are not required, as our art department will work out rough sketches submitted from contributors. IT IS THEREFORE NOT NECESSARY FOR CONTRIBUTORS TO SPEND MUCH TIME IN SKETCHING VARIOUS IDEAS. When sending contributions enclose return postage if manuscript is to be returned if not used. ALL CONTRIBUTIONS APPEARING IN THIS DEPARTMENT ARE PAID FOR ON PUBLICATION.

FIRST PRIZE TWO DOLLARS.

ROTARY TUNER.

THE following is a description of a single slide Rotary tuner of my own design. The circle is cut from  $\frac{3}{4}$  inch stock 1 inch wide and is wound

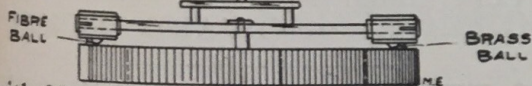
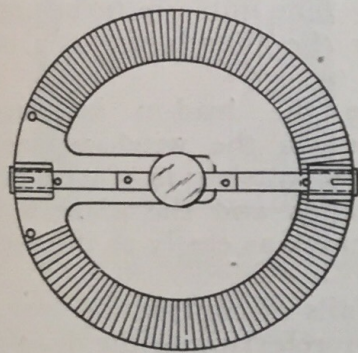

with No. 24 enameled wire. All arms are of square brass  $\frac{1}{4}$  inch by  $\frac{1}{4}$  inch. The supports of a somewhat smaller diameter. Sliders are mounted on ends

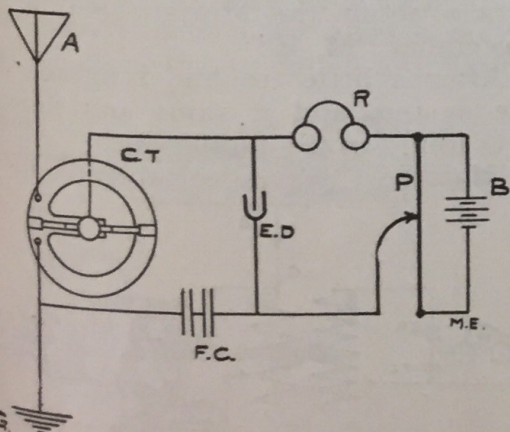

of long arms and are kept in place by set screws. In one of the sliders in place of a brass ball is a fibre one. The rest is all very simple. It will be plain upon a little study.

Contributed by E. J. SORTORE.

SECOND PRIZE ONE DOLLAR.

AUTOMATIC WINDOW CLOSER

Those who enjoy sleeping with their windows open and yet do not like the idea of being rained in on may appreciate the little contrivance herewith illustrated. The sketch is self-explanatory but a word as to the way in which it operates will not be out of place. A battery (B) and sensitive relay (R) are connected up as shown with the solution tray (S), which is simply a small cigar box, paraffined on the inside to make water-tight, in which are fastened two copper plates or electrodes (C,C) (Fig. 2) and these connected with the circuit by means of binding posts; the plates should be about  $\frac{1}{4}$  inch apart. The box is fastened on the window sill outside, where the first drops of rain will reach it, and a little common salt sprinkled over the copper plates and in between them.

When it starts to rain the salt, which when dry is a poor conductor, will form a solution which is a good conductor, and will let enough current through to work the relay (R). This in turn closes the lighting circuit as shown, and the little motor, which may be a fan motor or any such small motor, starts winding in the window cord, attached to the sash of the window. Thus the window is lowered and as it comes down the nail or screw (N) strikes the lever (L) which in turn pulls the switch (A) and breaks the battery circuit. This releases the relay which thus breaks the lighting circuit and stops the motor. The momentum of the window will carry it the rest of the way down, but if one wishes to be more accurate all he has to do is to vary

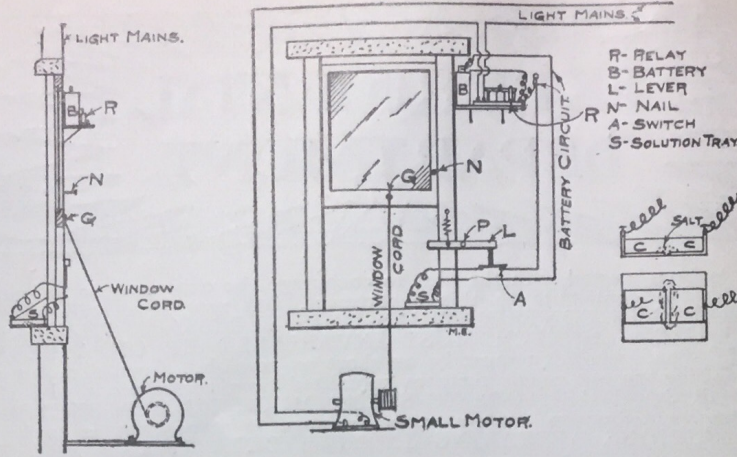

Automatic Window Closer

the position of the nail (N) so that the circuit may be broken at any time he chooses.

This might also come in handy on a third floor window in the event of a sudden storm, especially if it is the custom to leave the window open and as it is not always convenient to run up three flights of steps in a hurry.

Contributed by  
"IKE" STEWART.

**AN EFFICIENT AERIAL LEAD-IN.**

The following is an account of how to make a good lead-in.

Take a hard rubber tube 4 x 3/4 inches and having a 3-16 inch hole. Put the tube in a lathe and turn it down so that there will be a one inch space in the center, 1-16 inch higher than the part immediately next to it. Then

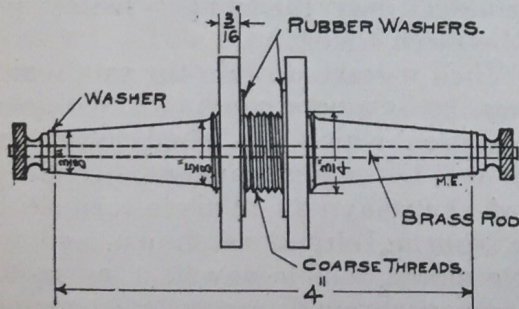

taper the part 1 1/2 inches from the edge of the raised part in the middle to the end, making the end 3/8 inch in diameter. On the raised part cut some rather coarse threads. Now take the hard rubber ends from a large magnet. These ends should be 2 inches in diameter, 3-16 inch thick, and have a hole 5/8 inch in diameter. If the experimenter has no such magnet he can turn them from a piece of hard rubber sheet. In the holes cut threads to cor-

respond with those on the rubber tube. A brass rod 1/8 inch in diameter, having threads cut on it for a distance of one inch from either end, and 5 1/2 inches long, is placed in the tube. Washers are then placed on either end and a circular nut also. The nuts are turned up tight and then the thumb-nut of a binding post put on.

In use the lead-in is placed in a hole cut in the window-pane; if a soft rubber washer is placed between the coil ends and the glass it is not liable to crack as easily as if it were not there.

All details of construction may easily be seen by referring to the drawing.

Contributed by  
HOWARD TUCKER.

**TO RECEIVE LONG AND SHORT WAVES.**

I saw an article referring to a switch for long and short waves in the article about the Military Set in the December "M. E."

After a little trouble, I figured out the system and it skins any thing I ever found in the tuning line.

The short waves certainly come in

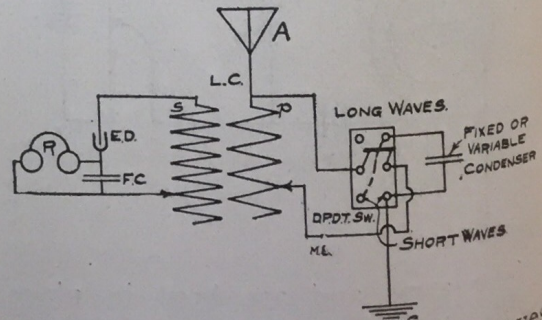

best on that side and the longer waves come in best the other way.

H. H. ANDERSON.  
Contributed by

**INTERRUPTER COOLING.**

A very inexpensive yet satisfactory way to cool your interrupter, is to procure a quart size can, such as a "quart size ice cream can," which may be procured at any hardware store. Set the interrupter into this and fill the can to about one inch from the top with

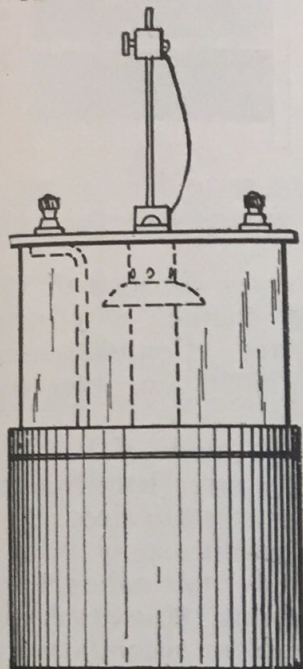

M.E.

water; this will eliminate your interrupter trouble to a great extent and increase your sending range materially.

Contributed by

M. B. JOHNSON.

**SUBSTITUTE FOR SOLDER.**

Many experimenters do not have the facilities to solder joints on their antenna, or where they have aluminum wire, cannot make very good connection, for often the so called aluminum

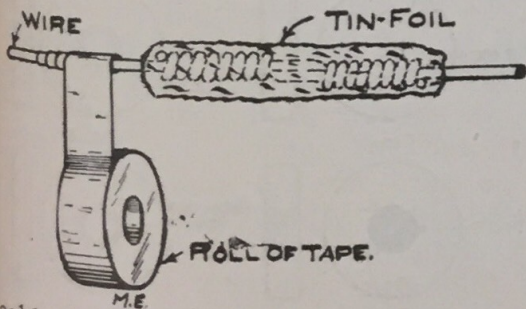

M.E.

solder is hard to use. The following is a method which I have used and which works very well.

First scrape the wires clean and make the joint. Then wrap the joint with a piece of tin-foil large enough to go around the wires a few times. After

this, wrap the whole with friction tape, which will keep the dirt and dampness out.

Contributed by

PAUL R. GARRISON.

**A SIMPLE CIRCUIT-BREAKER.**

The average experimenter "blows many fuses," which usually cost quite a little to keep replaced. Here is a description of a simple circuit-breaker which will save many fuses. The back is a piece of wood, covered with asbestos, while the cover is a coffee-can cut to the right length; this makes a very neat looking piece of apparatus. The magnet is made by winding about 75 turns of No. 14, d. c. c. magnet wire on a machine bolt as a core. A piece of brass is then shaped and drilled to hold the magnet.

A piece of tin or soft iron is next soldered or screwed onto a piece of copper, which is shown at A; another piece of copper with a handle fastened on it is shown at B.

The arrangement shown at C is to break the circuit by hand, and is also used in setting the circuit-breaker.

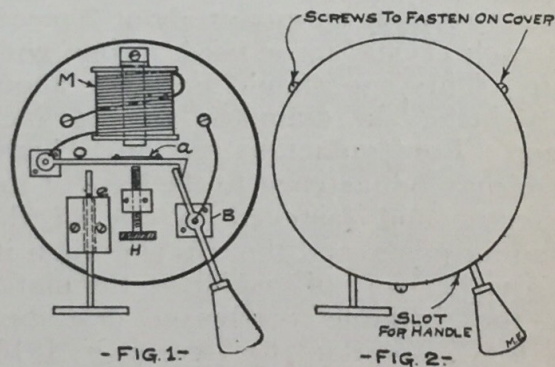

- FIG. 1 -

- FIG. 2 -

The levers are supported on blocks of hard wood which are screwed to the base. The binding parts are on the back, as the circuit-breaker was made for switch-board. The arm O can be adjusted by the screw H so that it will break at a small or large current.

Contributed by

IRVING WINDER.

**WIRELESS HELPS.**

A small receiving condenser may be made with a small wire spool, two strips of tin-foil about five feet long, two strips of waxed paper a little longer than the tin-foil strips, and two binding-posts. The spool should be about

2½ inches high. The space between the spool-heads should be about one and a quarter inches wide. The tin-foil should be wound around the core, each piece being separated by a strip of waxed paper. The two binding-posts may be fastened to one of the spool-heads and connections from each piece of tin-foil brought out to these. The complete condenser is shown in Figure I.

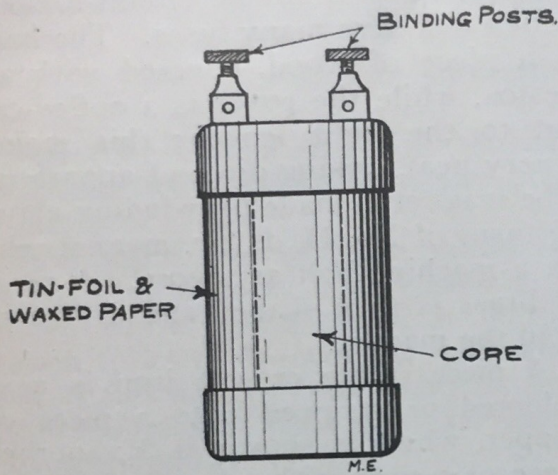

-FIG. 1-

A simple way to do away with a large number of detector cups to hold the crystals is to mount about 2 pieces of each crystal to be used, in one wide cup. This cup should be made about 1½ inches in diameter and ¼ inch deep. For contact to the cup a brass disk may be fastened to the base of the detector and fastened to one of the binding-posts, and the cup laid upon it.

Another way of insulating the plates in the variable condenser described by R. C. Bodie in the December, 1910, issue is to enamel the plates on both sides, instead of placing the empire cloth on the plates. The enamel is easier to put on, and will give just as good results if laid on evenly.

Contributed by  
**CHARLES A. EARLEY.**

**A STEP-DOWN TRANSFORMER.**

The illustration shows a small, neat, and effective transformer that can be made by most any experimenter at a very small cost.

Produce a wood spool 4 inches wide and 4 inches long. For the secondary winding—4 layers of No. 16 D. C. C. wire is wound next to the core of the

spool. Connections are made on 1st, 2nd and 4th layers to binding posts on end of the spool.

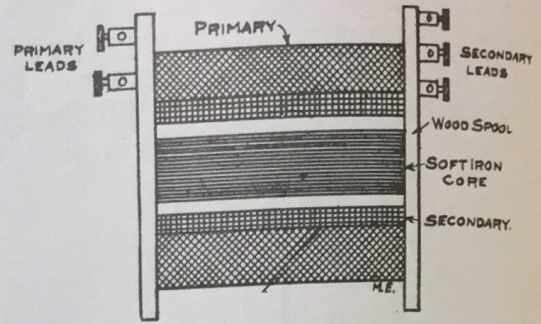

Over the secondary a few layers of paper are wound to serve as insulation tube.

The primary consists of 1¾ pounds of No. 24 enamel wire wound over the secondary. Connections are made to binding posts on other side of the spool.

The core is made of No. 22 soft iron wire cut the same length as the spool, and packed tightly into the hole in the center of the spool.

The transformer takes 110 volts A. C. and is about 100 watt capacity, taking 6 volts from secondary leads.

Contributed by  
**PAUL PARMAN.**

**A SIMPLE THUMB-SCREW.**

Take a piece of 5/8 inch fibre and turn out a round piece about 1¼ inch diameter. Then drill a hole in the center large enough to pass over the rod and countersink this hole large enough to take the nut tightly, then force the nut into the countersink and place both nut and fibre on rod. Then fill the remainder of the countersink

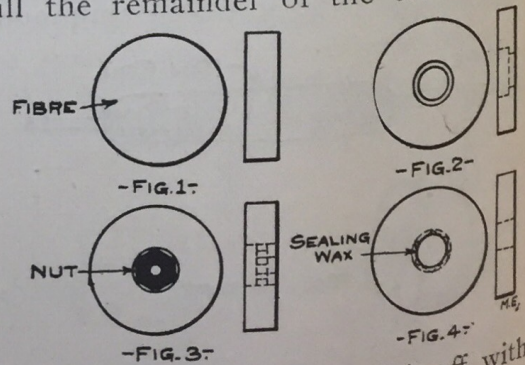

with sealing wax and polish off with a piece of emery cloth. You then have a handsome and serviceable thumb-screw.

Contributed by  
**R. VON-VALTIER.**

**A HOME MADE WET BATTERY.**

Many amateurs who wish to make a wet battery to run their spark coil, can easily make the following with great success.

First procure a one (1) gallon crock or jar and a wooden cover about one-fourth ( $\frac{1}{4}$ ) inch thick. Next get two old dry batteries and take the carbons out, also get some sheet zinc about three (3) inches wide and  $\frac{1}{8}$  inch thick and long enough to reach to about 1

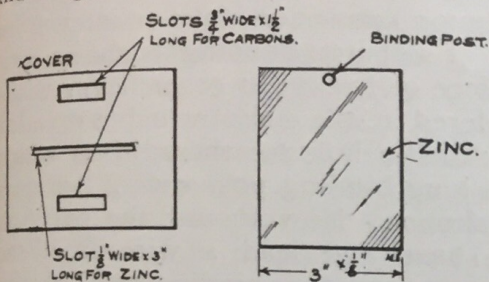

inch from the bottom of the crock. Now take the cover and cut three (3) holes in the top as per sketch, insert the carbons with the binding posts on. Next put the zinc in with a binding post on, which will also serve as a

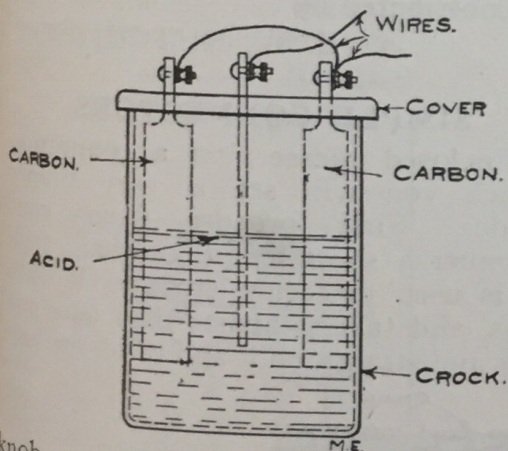

knob as well as a connection. Now make a solution of Potassium Bichromate 8 oz; Sulphuric Acid 17 oz. and Water 56 oz. Connect the carbons together and bring one wire out for connections from both carbons and one from the zinc. When the battery is not in use take out the zinc as the acid eats it very rapidly. This battery will give two volts if properly constructed. If four cells are used will run a one inch coil.

Contributed by  
**RAYMOND C. RUFFING.**

**A NOVEL PRACTICING SET.**

Every wireless amateur should realize the importance of gaining a

thorough knowledge of the code, as in this lies success in practical wireless operation. The method of practice

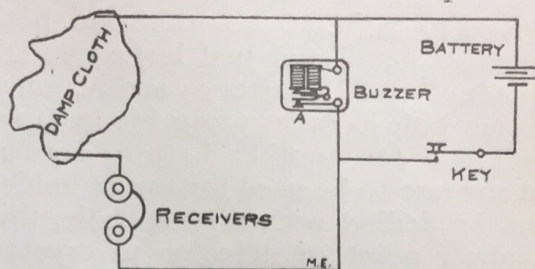

illustrated (which can be used by two learners for practice in sending and receiving) will give a note in the receivers similar to that in ordinary messages. The pitch or frequency may be regulated by pressure on the contact at A (see diag.) Also the intensity is variable according to the degree of dampness of the cloth, and distance apart of the terminals. One good dry cell is sufficient to operate the buzzer, which should be well wrapped up in cloths to prevent its noise interfering with the signals in the receivers. Any number of phones may be placed in circuit.

Contributed by

"H. W. D."

**A SIMPLE SLIDER.**

The sketch shows one of the economies I resorted to when building my potentiometer.

The special feature of it lies in part "A."

The hole in this for the slider rod is drilled considerably off-centre.

A piece of sheet brass shaped as shown is soldered to it to make contact with the wire.

The part of "A" that is off-centre,

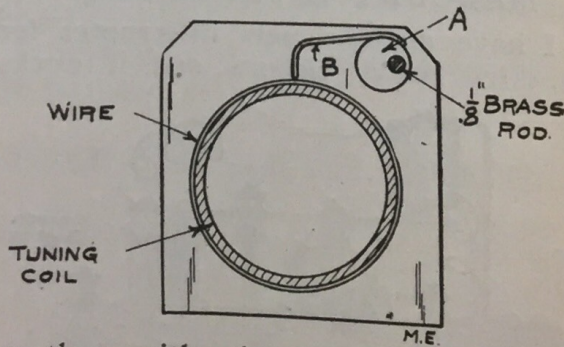

together with the weight of B, is heavy enough to make good contact with the wire.

Contributed by

**LOUIS MACKLER.**

### SIMPLE DETECTOR STAND.

Two phosphor bronze springs 3 in. long and  $\frac{5}{8}$  in. wide at one end, and tapered to  $\frac{3}{8}$  in. at the other end, both drilled at small end just large enough to admit 8-32 battery screw, also another hole in each spring  $1\frac{1}{4}$  in. from small end for another battery screw; and the one to be used for top of holder must be drilled with a  $\frac{3}{8}$  in. hole, this to admit point of detector to crystal. Holes in base must correspond with the small holes in springs. Put

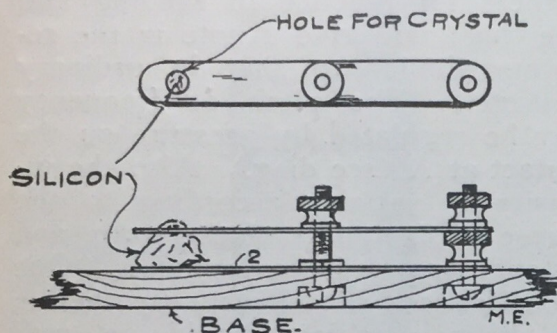

battery screws up through base from bottom and put bottom spring in place, now screw one hexagon nut on the screw nearest the middle of spring, and a battery thumb nut on the screw in the end of spring, and place the top spring on these, and another thumb nut on each of the screws. The wire for connection can then be clamped under the thumb nut at the end of the springs, while the other thumb nut is to clamp the crystal which is placed directly under the large hole in the top spring. This holder can be used with almost any good form of crystal, as it is immovable.

Contributed by

J. N. DAVIS

### MERCURY INTERRUPTER.

I have made a new interrupter for breaking heavy circuits and it works

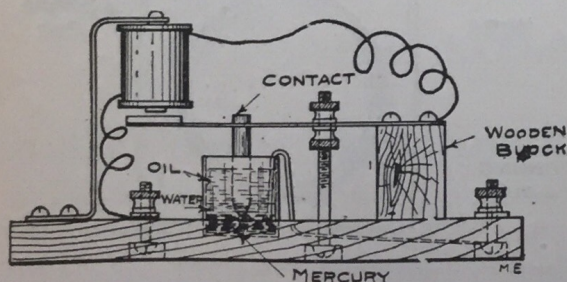

splendidly. Wind a bell magnet full of No. 14 insulated wire and secure to a brass standard as shown in drawing. Make a base of any hard wood—the

dimensions are immaterial—and drill holes as shown.

Now get a bottle (round) about 2 in. in diameter and cut off leaving 1 inch from the base of same and drill a hole to suit the "cup" which you now have in the wooden base as shown. Fill the cup  $\frac{1}{4}$  full with mercury, then pour over the mercury just enough water to cover all parts of same; the success of the interrupter depends on this point. Now fill the rest up with common kerosene. Make an interrupter out of soft iron banding as shown with a piece of No. 8 (or other heavy wire) soldered in, the end of which is rounded off; drill a hole for the adjuster which is a long binding post with 2 lock nuts as shown. Now mount the parts on the base and lead a wire from the mercury cup to a binding post; the interrupter is now ready to work. With a pipette or a medicine dropper fill the cup with mercury until it just touches the contact on the vibrator, now put in the water and the kerosene and regulate the adjuster accordingly.

Contributed by

E. W. HUTCHINSON.

### SIMPLE CONNECTORS.

Enclosed please find a connection which you will see is very simply made. First procure from your plumber a short length of chain such as is used to secure stoppers in bath tubs, and take it apart; then take one link and straighten it and bend one half



in a U shape. Now put your wire in and clinch it, and with a pair of side cutting pliers snip the other end off near the very end. You will save time skinning wire and bending it to fit binding posts.

Contributed by

EDWARD W. HUTCHINSON.

### HOW TO STOP LEAKAGES.

Difficulty in transmitting can, in some cases, be traced to improper insulation of the transmitting set and lead-in. The greatest of these is the sending



inductance. Many amateurs make their helix of unseasoned lumber, without placing a sheet of fiber or hard rubber between the turns of wire and the frame, thus causing a loss of energy. Some paint this instrument with a lead-paint, increasing the loss. The Aerial-Switch is sometimes constructed with a wooden base, with the same result. Condensers and spark-gaps cause a loss of energy if not insulated properly. Some amateurs give all their attention to insulating the lead-in after it leaves the house. This is all right, but it should receive the same attention on the inside. A good way to do this is to suspend the lead-in from the ceiling like a bell-rope in a street car, with a cleat for insulation. Small stations can increase their radiation by looking after these points.

Contributed by  
FANNON BEAUCHAMP.

**REVERSE SWITCH.**

I had some trouble in connecting up my motor until I discovered this way and if anyone else has the same trouble I would like to help him out.

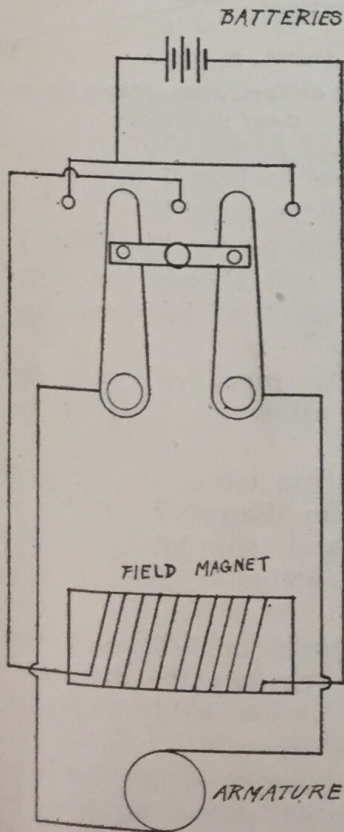

I think the diagram explains itself. There are only three points instead of four but I have found it works just as well.  
Contributed by  
AUGUSTE F. PECK.

**A CLEVER INSTRUMENT.**

Fig. 1 shows a simple instrument that can be used as a circuit alarm (to ring a bell when the voltage passes a certain point, adjustable) a telegraph sounder and an automatic key for con-

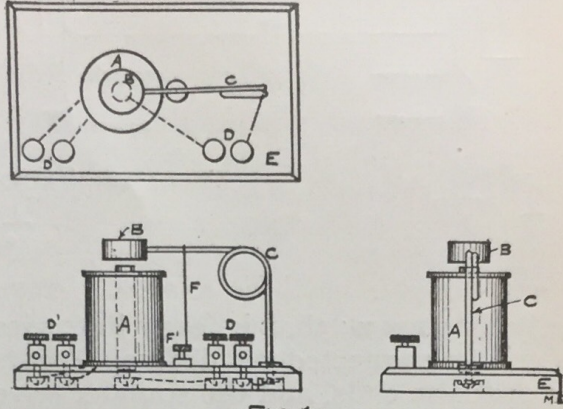

-FIG. 1-

trolling high tension current such as used in the use of a wireless telegraph

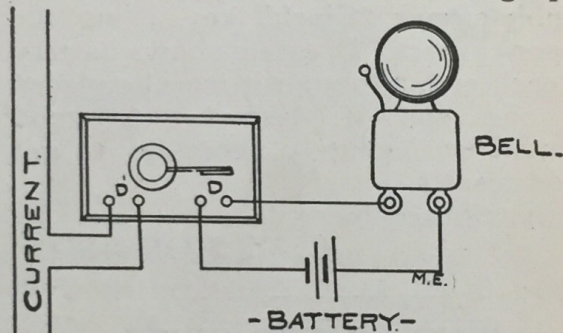

-FIG. 2-

station transformer, used as a circuit alarm it is connected, as shown in Fig. 2, and telegraph sounder, as shown in

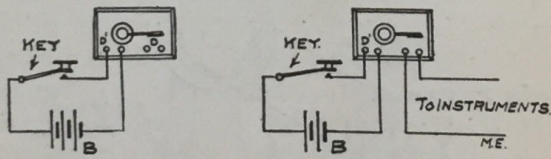

-FIG. 3-

-FIG. 4-

Fig. 3., and as an Automatic Key, as shown in Fig 4.

I have used it and find it answers the purpose very well.

**OPEN CIRCUIT TELEGRAPH.**

I present herewith a diagram showing connections for an Open Circuit Telegraph which can be used with dry cells, and does not require the use of switches, which have been the weak part of diagrams heretofore shown. For, in case one end left the switch on the wrong contact, it either exhausted the batteries, or made it impossible for the distant station to call.

As the diagram shows the idea quite clearly, but little explanation is necessary.

Care should be taken that line wires are connected to the telegraph keys ex-

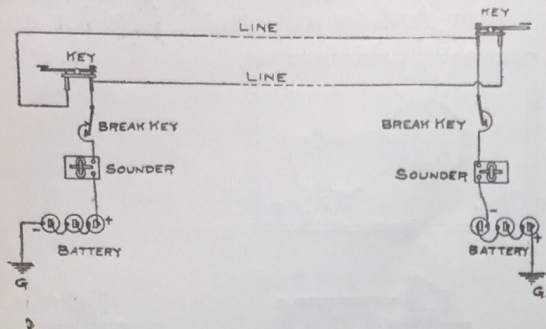

actly as shown; that is, each line wire is to be connected to different posts on opposite ends, and the sounder wire is to be connected to the back contact of key at each end. The break key should be similar to the "Electro" double-circuit "Cinch" key, using the upper contact. Diagram shows battery at each end, although it may be placed at one end if desired. A good ground is absolutely necessary to get good results.

Contributed by  
C. W. MORRISON.

**WINDER FOR COILS.**

My lathe being broken I had to think of another way to wind my coil. First

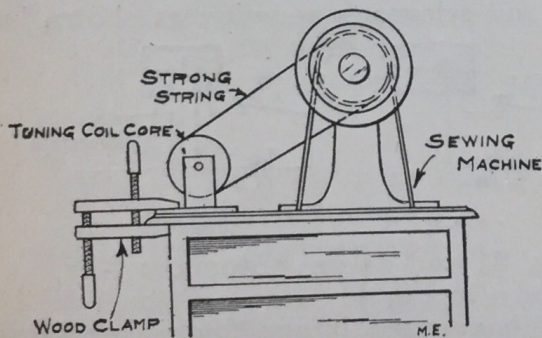

make a frame by taking a piece of board about 2 in. longer than the core, and nail two pieces upright on each

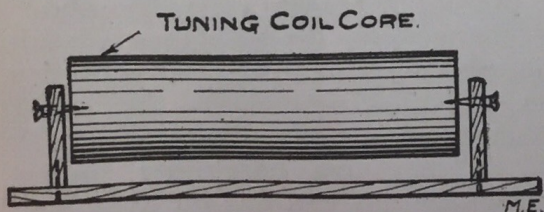

end as shown. Then find the centers of both ends of the core and drill a

small centre. Then drive a screw in about the middle of the two upright pieces through to meet the centers of the core; now drive the screws in until the core runs true.

By using a wood clamp it can be clamped firmly to the sewing machine. By connecting a strong string around the wheel of the machine and around the core it is ready for work.

Contributed by  
NORRIS A. BUCHTER.

**A HANDY SCRAPER.**

More than likely many of the readers of *Modern Electrics* have had more or less difficulty in removing the insulation from fine stranded wire, ordinary lamp cord especially.

With the help of the simple little

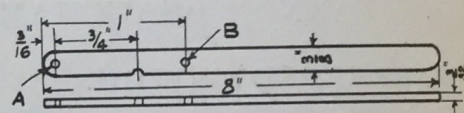

-FIG. 1-

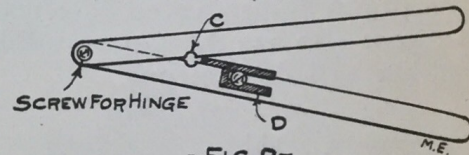

-FIG. 2-

-TO BE MADE OF TOOL STEEL OR COLD ROLLED STEEL  
CASE HARDENED-

tool shown in Fig. 1 and 2, they will have no more trouble.

Make two pieces like Fig. 1 out of steel. A. and B. are holes drilled in one piece so that they can be tapped for screws.

The other piece will only have one hole A to allow the body of the screw to pass.

The cutting edges C. are ground to as near the diameter of the wire as possible and should come together like the cutting edges of a pair of shears.

D is made of 1-32 inch steel and is used to regulate the distance of the cutting jaws, is held in position by the screws shown.

To use the scraper cut the insulation where wanted, providing it is not too far from the end and with the jaws closed draw it towards the end of the wire as though you were using a knife.

Contributed by  
E. H. STABBE.

### SWITCH POINTS AND INSULATED HANDLES.

Take the binding posts from the zinc of an old dry cell and file or saw on dotted line. Secure some handles at a hardware store such as used for lids; as they

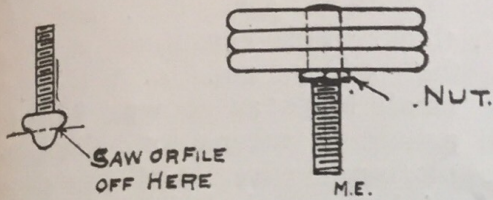

come in different shapes and sizes they present a neat appearance and make a perfect insulating handle for detectors, sliders, variable condensers, switches, etc.

Contributed by  
HAROLD B. ELVERSON.

### WHEATSTONE BRIDGE.

It is often necessary to determine the resistance of certain pieces of apparatus and as a Wheatstone Bridge set is rather an expensive affair, I will show how I used a potentiometer. I used the kind wound with German silver

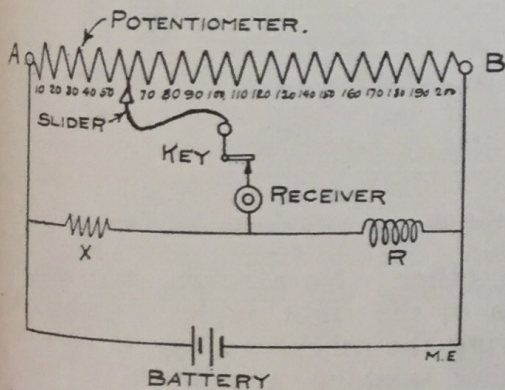

wire; the carbon rod type does not give accurate results. First mark off the slide into a convenient number of parts and number them so that the distance between the slider and the ends can be easily read. Connect as shown, X being the unknown resistance or apparatus to be measured, R is a known resistance such as a 75 ohm telephone receiver and T is a telephone receiver of any resistance. The known resistance should not be too far away from the unknown. Now move the slider back and forth until the point is reached where the least noise is heard in receiver T, when the circuit

is opened and closed by a push button or key at K. Then  $X = \frac{aR}{b}$  where a = the number of parts between end A and the slider and b = number of parts between the slider and end B.

Contributed by  
HEWITT O. FEARN.

### COMPACT TUNING DEVICE.

Upon seeing the Navy standard receiving set apparatus used, I noted that they used a small oscillation transformer, that could take only average sized waves, and a loading coil in series with aerial and primary, to take in long waves. The reason why the primary was not utilized, or was not large enough to receive long

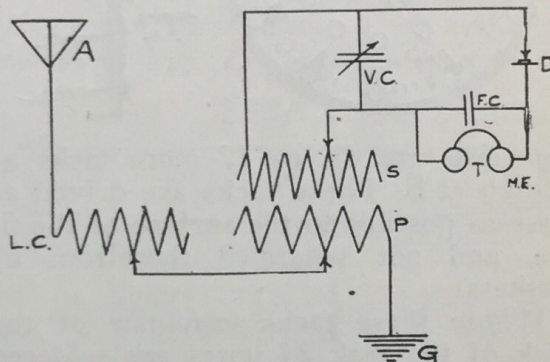

waves properly, was because better selectivity could be secured by having a small primary, and then using a loading coil for taking in long waves.

Having an oscillation transformer, with a primary that could take a 2000 meter wave, and bearing in mind that better tuning could be accomplished by having a loading coil, I thought I would try and design a loose coupler, but with loading coil on primary of transformer, thereby dispensing with an extra instrument; a point on the primary was found where it could take 600 meter waves properly. At this point the wire was cut, having a short length for the primary and leaving the rest for a loading coil. The primary must have two sliders, one for varying primary of loose coupler, the other for varying loading coil, as shown in sketch.

This is another step towards compactness, and at the same time getting equal results. This has been found satisfactory in every respect, and I have received a distance of 700 miles with an aerial only 30 feet high, on more than one occasion. A very good circuit is given here.

Contributed by  
J. E. CROCKFORD.

### A HOME-MADE ELECTRIC ALARM.

Secure an ordinary alarm clock and replace its dial with some of fibre (about  $1/32$ " thick). Now secure 12 tacks, such as are used in upholstery, and drive them through the fibre at the extremities of the numerals as at A. Between the tacks and the dial are fibre washers of the same thickness as the dial. Below the

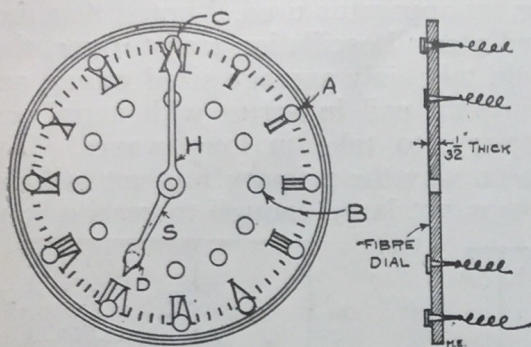

numerals are driven 12 more tacks as shown at B. These tacks are driven as close as possible to the surface of the fibre, and not separated therefrom by washers.

Where these tacks terminate at the back of the dial, 24 wires are soldered and connected with the terminals of another dial of the same construction as the above, and in series with it and an ordinary bell or buzzer.

When the alarm is desired to go off (say at 7 o'clock), the hands on the dial (not shown in picture) are placed for 7 o'clock. It may now readily be seen that when the clock A has reached the designated hour, the hand H, resting on contact C, and the hand S, resting on contact D, will complete the circuit and cause the bell to ring. It will be automatically shut off when the hand H clears its contact C.

This is a very reliable and easily constructed clock and the cost is very small in comparison to the service which it gives.

Contributed by

GEO. GANISON.

### AN ELECTROLYTIC DETECTOR

A very simple but efficient bare-point electrolytic detector may be made as follows: First make a base  $4 \times 6 \times 1/2$  inches, as shown in the drawing, beveling the edges nicely. Now procure a piece of brass strip  $6 1/4$

inches long,  $1/2$  inch wide and  $1/32$  inch thick and shape it as shown at "A." Drill small holes in the foot of brass legs as shown and also drill a  $1/8$  inch hole in the top of the saddle "A." Next cut a piece of hard, springy brass strip  $4 1/2$  inches long,  $1/2$  inch wide at one end and  $3/8$  inch wide at the other, and  $1/32$  inch thick. This constitutes part "E." In the wider end of "E" drill two small holes as shown. Now we will provide a means for holding the fine platinum wire. Cut two pieces of hard brass  $1/2$  inch long,  $3/16$  inch wide, and  $1/64$  inch thick. Bend each piece at right angles in the middle, thus making a right angle with the sides  $1/4$  inch long, being very careful to get both pieces bent to exactly the same angle so that they will fit very closely when placed one on

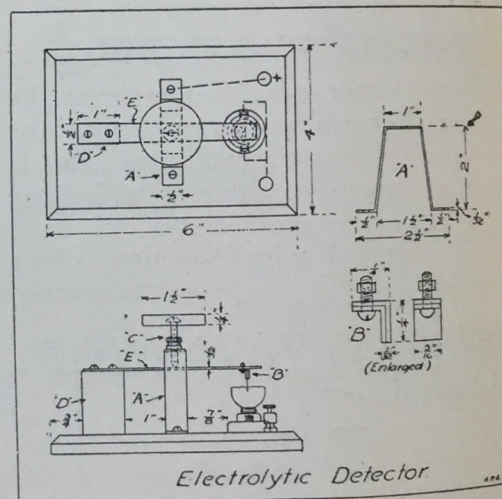

the other. Now solder two similar legs of the right angles together, allowing the other two legs to come together, making a tight fit. Drill a small hole (about  $3/32$  inch) through the soldered legs to admit a small brass machine bolt as shown in Fig. B. A hole must also be drilled through "E"  $1/2$  inch from the narrow end. This must be the same size as that in "B" and must take the same machine bolt. Now the thumbscrew "C" is made by molding a battery screw into sealing wax as described in the August number of MODERN ELECTRICS. The battery nut is soldered to "A" directly over the hole drilled in the top of "A."

Now procure an old 6-volt battery lamp with porcelain receptacle. Cut

off the top of the bulb as shown. This is best done by first nipping off the point of the bulb and then etching around the side of the bulb where it is to be cut off.

The next step is mounting the different parts. By following the dimensions given, no difficulty will be had with this. To insert the platinum wire, first wrap about one-half of it with tin foil. With a knife blade open the loose legs of "B" and insert the tinfoil end of the wire, withdraw the knife blade and the two pieces of brass will hold the wire between them. Now by means of the machine bolt attach "B" to "E" in position shown.

Place two binding posts as in sketch, making connections as shown. Always connect the positive or carbon pole of the battery to the post marked X. Place the electrolyte, made of one part nitric acid to four parts distilled water, in the lamp bulb and adjust height of platinum wire by means of the thumb screw.

Contributed by

A. P. GOMPF.

HELIX INSULATION.

One day while rebuilding a helix I thought of this method of insulation which is cheap, efficient and easily made. Make the ends of the helix any desired diameter and the dowels any length to suit the height of the helix, then secure three dozen of the insulators like in illustration and enough length of 3/16" dowel. Be sure insulators will slip easily over the dowel.

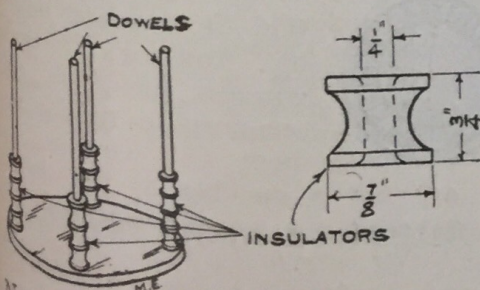

Now set dowels in base of helix per illustration. Be sure they set snug when pushed. When set, slip insulators on the dowels, then set top on dowels. Take great care that the helix is not lopsided. It is now ready for the wire.

Contributed by

JAMES F. TRAINOR.

A GOOD HEADBAND.

First secure, at a tin-shop or supply-house, two pieces of sheet brass, each 10 3/4" long by 1 1/2" wide, and a small piece, 1" by 4 1/8". These should be of about 24 gauge, and what is known to tanners as "half-hard." Also get a piece of 18 or 20 gauge brass, 1/2" by 4".

The large pieces should be tapered to one inch at the ends (Fig. 1.). This can best be done at the tin-shop on the square-shears. The ends are then rounded and two 1/8" holes made in each piece, 1/2" from each end. Next cut the heavy strip into two pieces, each 2" long, and round the ends of each, making 1/8" holes in each end of these, also. They are then bent as in Fig. 2. The exact angle of

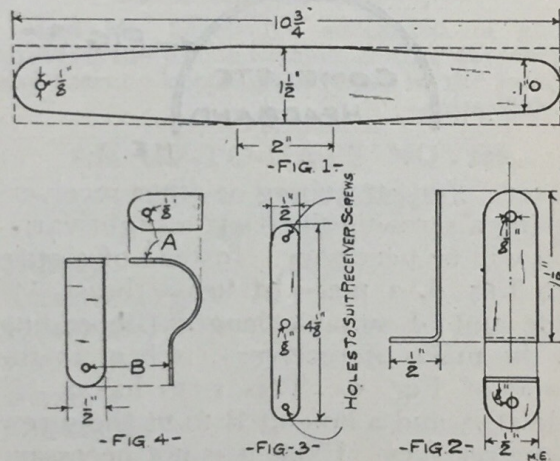

this bend should be regulated after the headband is finished so as to make the phones fit properly. The remaining piece is cut lengthwise into two pieces, each 1/2" by 4 1/8". These strips are rounded on the ends, and each has holes in the ends to fit the screws in the sides of the receivers, and a 1/8" hole in the center.

Before assembling, bend the large pieces to the shape of a letter C, leaving a gap of about three inches between the ends. The heavy strips are bent like Fig. 2, and the remaining strips are bent to half-circles. These are the stirrups which go over the phones.

The headband is put together with 1/8" round-head brass rivets, obtainable at the tin-shop. The straight ends of the heavy strip (Fig. 2.) go between the ends of the large pieces. The small pieces (Fig. 3.) are then riveted to the end of the heavy ones, and the receivers are fastened into these stirrups by means of the screws which come in them.

Care should be taken not to have the rivets too tight. They should allow the joints to turn easily, but not to wobble.

The foregoing description is suitable for any standard make of wireless re-

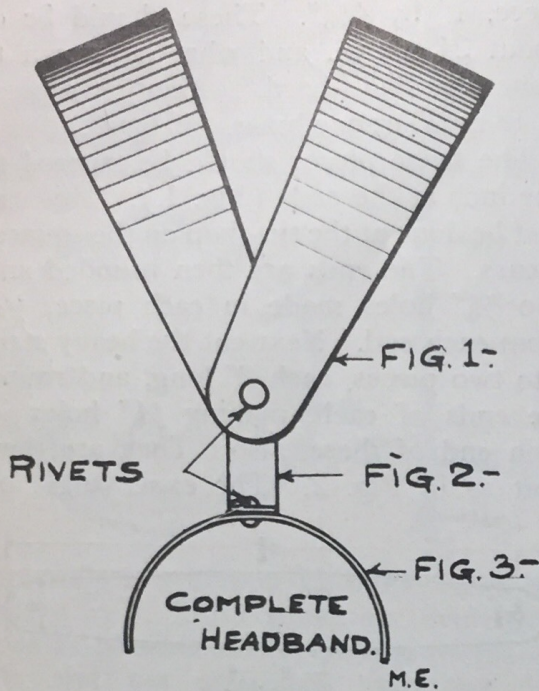

ceiver. For Stromberg or other receivers having a screw in the back, a slight variation will be necessary. Instead of a strip like Fig. 3, a piece of heavy brass  $\frac{1}{2}$ " wide and of suitable length (depending on the make of receiver), is bent to the shape of Fig. 4. This strip has a  $\frac{1}{4}$ " hole at A and a hole at B to fit the screw in the receiver. I find it is not necessary to make these headbands adjustable. If made to exact dimensions, as given, they will fit almost any head perfectly.

The finished headband may be cleaned up with fine sand or emery-paper. It should not cost above 15 or 20 cents complete, and the cost is not much greater if it is given a plate of nickel or lacquered. This makes a very serviceable and well-appearing headband.

Contributed by

E. E. ELY.

### SLIDER BAR ATTACHMENT.

An attachment for slider rod is made

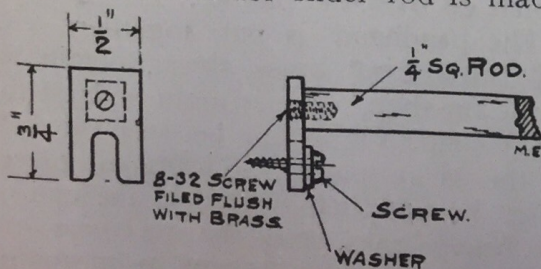

as per drawing. As some sliders are

longer than others it is evident that this attachment permits the use of a long slider where previously a shorter one was in use or vice versa.

Contributed by A. E. NEWMAN.

### SIMPLE ELECTRIC HORN.

In the November issue of MODERN ELECTRICS I noticed descriptions of several electric horns. I am enclosing drawing how one can be cheaply made, the material necessary being an electric bell with the gong removed, a large tomato or syrup can, a board and a block of wood.

First remove the ball from the bell armature, then solder the arm on same to the center of the end of the can. Mount a block of wood on the base and to this screw the bell. The can is fastened to the base with two bands of ribbon brass, or with two wood screws. The

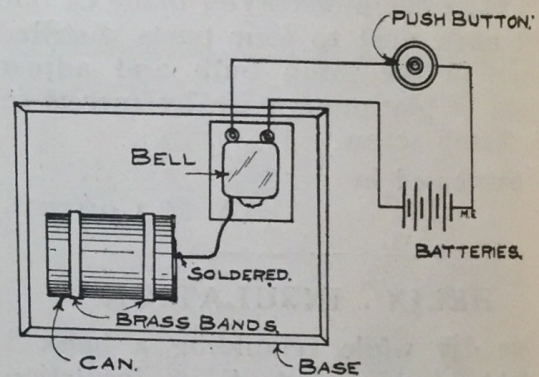

base should be made to suit the size of the can and bell, also the block. Connect as in diagram, using three or four cells of dry battery.

Contributed by JOS. L. WURM.

### W. A. O. A.



The Wireless Association of America, headed by America's foremost wireless men, has only one purpose: the advancement of "wireless." If

you are not a member as yet, do not fail to read the announcement in this issue. *No fees to be paid.*

Send to-day for free membership card. Join the Association. It is the most powerful wireless organization in the U. S. It will guard your interest when occasion arises.

### FOUR OFFERS.

See our splendid four offers in our advertising columns.

# Flying Sparks

## A "LARGE" ORCHESTRA

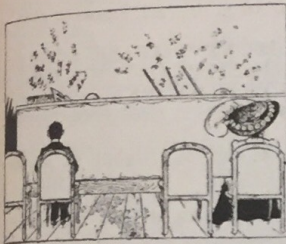

As seen in front

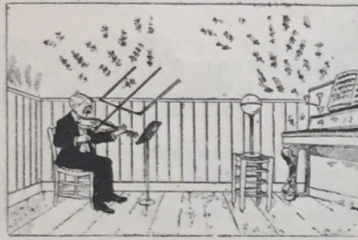

—and behind the scenes.  
—Pêlé Mêle

## A PARLOR TROLLEY



How Mr. Electricque succeeded in going through the parlor without soiling the carpet and thereby keeping the peace in the family.  
—Pêlé Mêle.

## PARCELS POST UP-TO-DATE

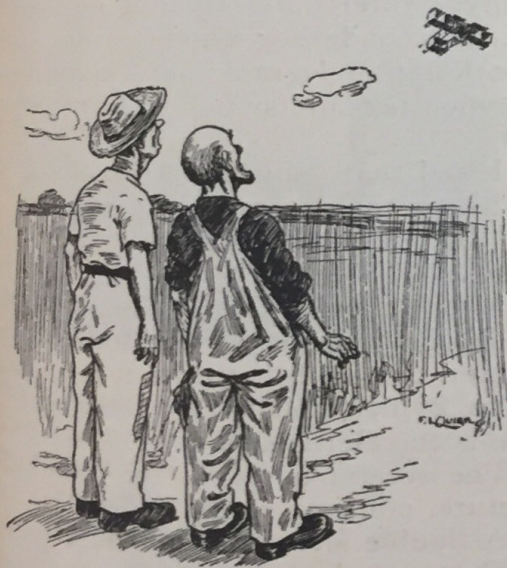

Old man from Missouri (viewing aeroplane for the first time)—“Holy Smokes! if that ain’t the queerest-lookin’ balloon I ever seen.”  
Young man (also from Missouri, scornfully)—“Balloon? That ain’t no balloon; that’s parcels goin’ by this noo wireless telegraph.”  
—Judge Stories.

## AN AMERICAN LYNCHING

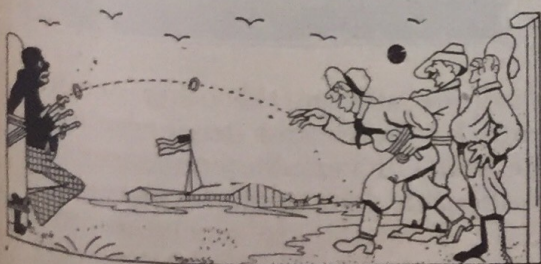

As seen through French eyes.—Pêlé Mêle.

## AN UP-TO-DATE NOVEL.

(Quick Lunch Style).  
By “FIPS.”

- Jimmy.
- Electric Light.
- Lamp Cord.
- Pin.
- Flash.
- Darkness.
- Howl.
- More Howls.
- Arnica.
- M. D.
- Spank.
- Bed.

## A WIRELESS HOOK-UP



## A TERRIBLE PREDICAMENT

“I swallowed a buttonhook last week.”  
“Heavens! And what did you do?”  
“Oh, not much. Had to eat button shoes to keep the hook busy.”—“Fips”

# Wireless Telegraph Contest

Our Wireless Station and our Laboratory Contest will be continued every month until further notice. The best photograph for each contest is awarded a monthly prize of Three (3) Dollars. If you have a good, clear photograph send it at once; you are doing yourself an injustice if you don't. If you have a wireless station or laboratory (no matter how small) have a photograph taken of it by all means. Photographs not used will be returned in 30 days.

PLEASE NOTE THAT THE DESCRIPTION OF THE STATION MUST NOT BE LONGER THAN 250 WORDS, AND THAT IT IS ESSENTIAL THAT ONLY ONE SIDE OF THE SHEET IS WRITTEN UPON. SHEET MUST BE TYPEWRITTEN OR WRITTEN BY PEN. DO NOT USE PENCIL. NO DESCRIPTION WILL BE ENTERED IN THE CONTEST UNLESS THESE RULES ARE CLOSELY ADHERED TO.

It is also advisable to send two prints of the photograph (one toned dark and one light) so we can have the choice of the one best suited for reproduction.

This competition is open freely to all who may desire to compete, without charge or consideration of any kind. Prospective contestants need not be subscribers for (the publication) in order to be entitled to compete for the prizes offered.

## FIRST PRIZE THREE DOLLARS.

**S**ENDING consists of E. I. Co's. 2 inch coil, strap key, home-made helix, E. I. Co. adjustables condenser, and two E. I. Co's. storage batteries under table, 8 volt, 60 amperes each.

Receiving consists of E. I. Co's. variable condenser, E. I. Co's. fixed condenser. Home-made loose coupler, E. I. Co's. pair of 1,000 ohm planes, also 3 of their 75 ohm phones, one E. I. Co's. Junior tuner, one M. E. S.

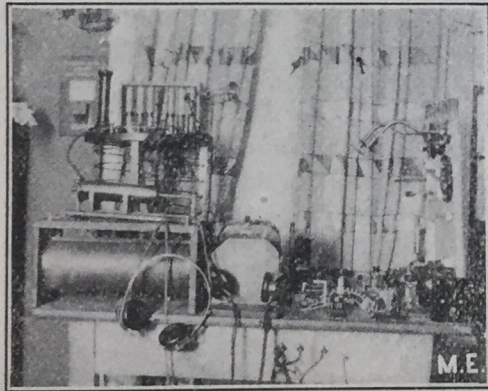

Co's. variable condenser, one A. B. C. Wireless Co's. tuner, double slide. I have two "Electro"-lytic, one silicon, carborundum, peroxide of lead, perikon, molybdenite, Galena detectors. All the switches on switch board, also fixtures, are E. I. Co's. make. I can throw any of the above detectors into action by a certain point on a switch.

JOHN WALKER JAMES.  
New Rochelle, N. Y.

## HONORABLE MENTION.

Enclosed please find photo of my wireless station.

The transmitting set is to the right of the picture, and consists of seven parts. A two inch spark coil, an electrolytic interrupter running on the 110 A. C., condenser (home-made), zinc spark-gap, telegraph key, home-made Leyden jar, and switch to turn current off.

I find that using the 110 volts A. C. is better than storage batteries.

When I had batteries I could send from 3 to 5 miles, but now I can send from 50 to 75 miles. The spark coil is really a  $\frac{1}{4}$  K. W. with the interrupter, and with batteries it is an ordinary 2 inch coil. The interrupter I use is the Gernsback style.

The receiving set, to the left of the picture, consists of the following:—

A double slide tuning coil, a potentiometer of about 300 ohms, two detec-

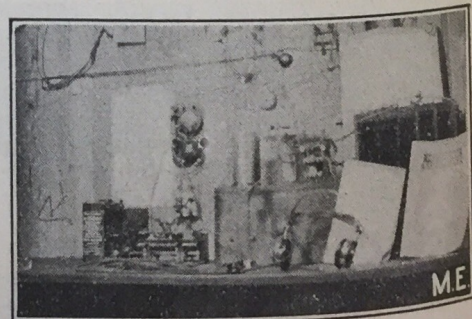

tors, one silicon, the other peroxide of lead, 1 coherer and decoherer (seen on the wall), 1 variable condenser, 1 fixed condenser (not seen in picture), 1 D. P. D. T. switch to receive or to send. batteries to work with the coherer and decoherer, and 2,000 ohm head set. All



of these instruments were bought from the E. I. Co.

The coherer and decoherer give me notice when messages are being sent.

With this outfit I have had splendid results and with the help of "Modern Electrics" I hope to be successful.

ATHOLE PEIRCE.

Victoria, B. C.

**HONORABLE MENTION.**

Enclosed please find photo of my wireless station.

Receiving.—Loose coupler in background, E. I. Co's. variable and fixed condensers in front of loose coupler, silicon and perikon detectors in front of condensers. Pair 2,000 ohms receivers to right of detectors. Detector test invisible in picture.

Sending.—Spark gap behind coil, Thordanson, 1/4 kilowatt transformer,

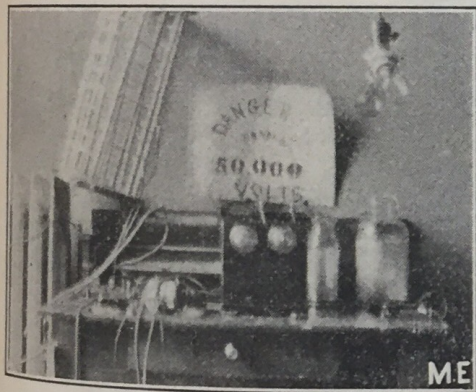

2 and 1 quart Leyden jars to right of transformer; key, in front of Leyden jars, helix on radiator. I use 110 V. A. C. for transformer.

My aerial consists of 4 strands of No. 14 aluminum wire 3 ft. apart, 120 ft. long. It is in shape of an angle. One leg of angle, 60 ft., other 60 ft. with 20° in between legs. Height 66 ft., 75 ft., 66 ft.

Chicago, Ill. EARLE M. FRIEND.

**HONORABLE MENTION.**

I am sending a photo and description of my Wireless set, which was constructed by knowledge obtained from "Modern Electrics."

For sending I use the following: a one inch coil, helix, adjustable condenser, zinc spark-gap key, and electrolytic interrupter run on 110 volt alternating current.

I use for receiving: 75 ohm phones, silicon or electrolytic detectors, double

slide tuner, potentiometer and fixed condenser.

The aerial is one hundred and forty-four feet long, three wires seven feet apart, and sixty feet from the ground.

With this set I have had very good



results, and am greatly indebted to "Modern Electrics."

JACK PLATT.

New Jersey.

**HONORABLE MENTION.**

Enclosed you will find photograph of my Wireless Telegraph Station.

The aerial is erected on the roof, sixty feet high from ground, and composed of three aluminum wires one hundred and fifty feet long, on six foot bamboo spreaders.

The sending instruments are to the right and consist of spark coil, helix, battery of Leyden jars, zinc spark

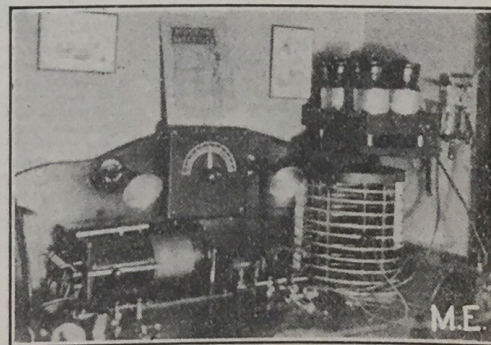

gap, key and six volt, sixty ampere storage battery for coil and lamps.

The receiving instruments are as follows:—Tuning transformer, fixed condenser, silicon detector, receivers, and variable condenser (in center)

I have constructed the above instruments with the aid of "Modern Electrics," which I find to be a great help.

LAWRENCE HAIGHT.

Brooklyn, N. Y.

# Electrical Patents for the Month

982,576. BATTERY HARRY WILLIAM DARBY, Winnipeg, Manitoba, Canada. Filed Mar. 31, 1910. Serial No. 552,729.

A two fluid battery comprising a casing having an upwardly projecting portion at the bottom thereof, thereby forming a U-shaped receptacle, a zinc U-shaped electrode having its lower end received within the receptacle and dipped in mercury located in the receptacle; a carbon electrode located on the upwardly projecting portion of the casing, said electrode being porous and containing one of the electrolytes, and an open ended porous insulator between the carbon and zinc electrodes, and resting on the

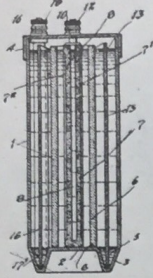

projecting portion of the casing, the other electrolyte being between the carbon electrode and the casing.

981,987. ELECTRIC CIGAR-LIGHTER. VICTOR EMMANUEL EXTROM and THOMAS GRAHAM BOARDMAN, Tomahawk, Wis. Filed Mar. 25, 1910. Serial No. 551,466.

In a cigar lighter, the combination with a body having a plurality of cavities therein, of a transformer located in one of said cavities, a lighting head located on the face of said body and being connected with said transformer, contacts in another of said cavities within said body, normally out of engagement with each other and connected with said transformer, and a push-button within said last-mentioned cavity and adapted to bring said contacts into engagement, and projecting above the surface of

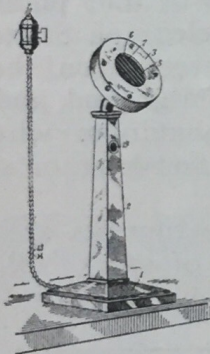

said body, whereby it may be readily operated, said lighting head comprising an insulating block, a resistance wire bent back and forth along the face of said block, terminal screws connected to said insulating wire, and a cover plate for said block, having an opening therein adapted to permit access to said resistance wire.

981,845. TELEGRAPHY. PATRICK B. DELANTY, South Orange, N. J., assignor to Delanty Telegraphic Transmitter Company, New York, N. Y., a Corporation of Maine. Filed Mar. 23, 1907. Serial No. 364,153.

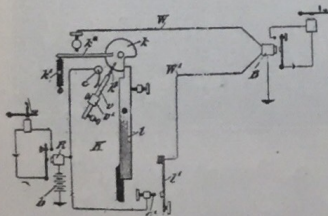

In telegraphy the method of transmitting messages which consists in sending part of a letter or character over one circuit and another part of said letter or character over another circuit and uniting both parts in their proper relation at a common receiver.

981,141. MEANS FOR PRODUCING A VACUUM PERCY H. THOMAS, East Orange, N. J., assignor to Cooper Hewitt Electric Company, New York, N. Y., a Corporation of New York. Filed Jan. 23, 1904. Serial No. 190,283.

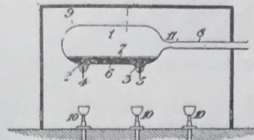

1. In an apparatus for exhausting a hermetically sealed chamber through the action of vaporization and expulsion of a volatilizable liquid, auxiliary expelling means said means consisting of an additional more easily volatilizable liquid introduced in the chamber prior to exhaustion.

981,552. APPARATUS FOR MEASURING AREAS BY MEANS OF ELECTRIC-RESISTANCE COILS JULIUS JOSEF GÖTZ, Offenbach-on-the-Main, Germany Filed Apr. 15, 1907. Serial No. 368,200.

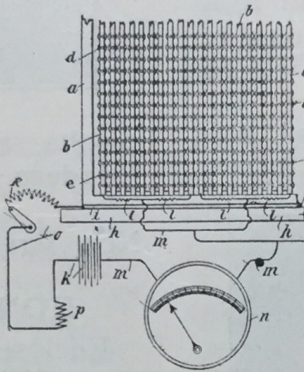

1. In a measuring device for measuring the area of irregular surfaces, a plate of conducting material adapted to receive the article, a frame in proximity to said plate, movable contact devices arranged in said frame, said contact devices being adapted to engage the plate of conducting material, ohmic resistances on said devices, a source of electric energy, a measuring device interposed between said source of energy and the resistances, said resistances having one end connected to one pole of the source, and the other end connected to the contact devices.

981,718. INCASED INDUCTION COIL. HENRY C. THOMSON, Boston, Mass., assignor to Electric Goods Manufacturing Company, a Corporation of Maine. Filed Mar. 6, 1909. Serial No. 481,621.

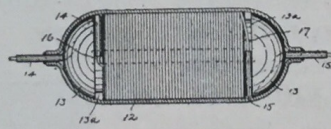

1. In combination with a coil of electrically insulated wire spooled about a longitudinal core, a tubular casing of ductile metal inclosing said coil, one end of said casing being radially contracted over the end of said coil and hermetically sealed with reference to the same, and including conductors electrically connected with the terminals of said coil, passing through said casing and forming leakage proof joints therewith.

980,945. ELECTRICAL BINDING-POST WILLIAM HECTOR, Chicago, Ill., assignor, by mesne assignments, to Automatic Electric Company, Chicago, Ill., a Corporation of Illinois. Filed Feb. 27, 1908. Serial No. 418,086.



1. A binding post for making electrical connections, comprising a sheet-metal frame or body providing terminal and attaching portions, and a metal plug upon which a portion of the sheet-metal is shrunk or contracted, and in which sockets are formed for the circuit wire and binding screw.

982,729. POROUS-CUP ELECTRODE. PIERRE J. KAMFRIDYK, New York, N. Y. Filed Nov. 9, 1907. Serial No. 401,430. Renewed May 20, 1910. Serial No. 562,408.

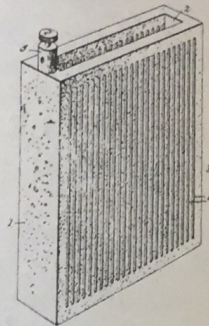

1. A separating wall constituting an electrode for two-fluid cells, composed of a substantially non-porous, highly conductive material having a wall so thin as to render said wall permeable to the electrolyte, said wall having reinforcing extensions laterally disposed.

981,996. TEMPERATURE-ALARM ALBERT GOLDSTEIN, New York, N. Y. assignor to International Electric Protection Company, a Corporation of New York. Filed Mar. 28, 1910. Serial No. 551,816.

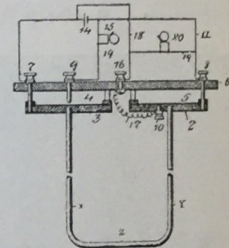

1. A temperature alarm apparatus comprising a pipe in loop form having open ends, diaphragms respectively disposed in front of said ends, terminals in proximity to said diaphragms, and means for electrically indicating a change in the contact relation between each of said diaphragms and its associated terminal.

980,781. ELECTRIC MELTING FURNACE KALL ALBERT FREDRIK HJORTH, Christiania, Norway. Filed July 28, 1909. Serial No. 510,019.

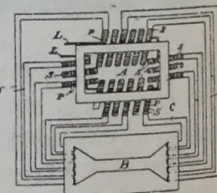

1. The combination with an electric furnace of a transformer having primary and secondary windings, said secondary windings of large cross-section and subdivided to reduce their temperature and connected to the furnace located outside the transformer the bath of said furnace forming a part of the secondary windings and of considerably greater resistance than them.

980,856. MULTIPLEX TELEPHONE AND TELEGRAPHY GEORGE OWEN SQUIRES, U. S. Army. Filed Nov. 5, 1910. Serial No. 590,801. (Dedicated to the public.)

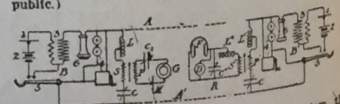

1. In a multiplex telephone and telegraph system, the combination of a pair of line wires, battery telephone sets bridged across said line wires; means at one end for impressing high frequency oscillations on said line wires; means for modifying said oscillations in accordance with speech; means at the other end for detecting said oscillations the complete circuit for the high frequency oscillations being tuned to the frequency of the oscillations.

Original Electrical Inventions for which Letters Patent Have Been Granted for Month Ending January 31



Queries and questions pertaining to the electrical arts, addressed to this department, will be published free of charge. Only answers to inquiries of general interest will be published here for the benefit of all readers.

On account of the large amount of inquiries received, it may not be possible to print all the answers in any one issue, as each has to take its turn. Correspondents should bear this in mind when writing.

Common questions will be promptly answered by mail if 10 cents to cover expenses have been enclosed. We can no longer undertake to furnish information by mail free of charge as in the past. There are as many as 150 letters a day now and it would be ruinous for us to continue acting as a free correspondence school.

If a quick reply is wanted by mail, a charge of 15 cents is made for each question. Special information requiring a large amount of calculation and labor cannot be furnished without remuneration. THE ORACLE has no fixed rate for such work, but will inform the correspondent promptly as to the charges involved.

NAME AND ADDRESS MUST ALWAYS BE GIVEN IN ALL LETTERS. WHEN WRITING ONLY ONE SIDE OF QUESTION SHEET MUST BE USED; DIAGRAMS AND DRAWINGS MUST INVARIABLY BE ON A SEPARATE SHEET. NOT MORE THAN THREE QUESTIONS MUST BE ASKED, NOR SHALL THE ORACLE ANSWER MORE THAN THIS NUMBER. NO ATTENTION PAID TO LETTERS NOT OBSERVING ABOVE RULES.

If you want anything electrical and don't know where to get it, THE ORACLE will give you such information free.

**1 K. W. TRANSFORMER AND HELIX.**

(846) D. E. McGee, Wash., asks:

Q. 1.—How many feet, how many lbs., what size, what kind, and how big a frame for a 1 K. W. helix? How many turns will there be on this helix?

A. 1.—Use 10 turns No. O. B. & S. aluminum wire, diameter of frame 14 inches. Turns spaced 1½ inches apart.

Q. 2.—What size core, how many lbs., what size wire, how many lbs., and how many pies in a 1 K. W. transformer?

A. 2.—We refer you to our book on "Construction of Induction Coils and Transformers" sent prepaid for 25 cents as we could not give all the information you ask for through these columns.

Q. 3.—How many glass plates with tin-foil on both sides 5x7 inches would it take for above transformer? How can I prevent Brush discharges of same without immersing in oil?

A. 3.—Same answer as for Question No. 2.

**TRANSFORMER.**

(847.) H. P. Haffa, Kansas, writes:

Q. 1.—I have an open core transformer. Core 1½x10; primary 2 layers No. 16. How many lbs. No. 34 enameled wire for secondary, same to be wound in 28 sections of ¼ inch thick?

A. 1.—We would advise using 4 lbs. of No. 34 enamel wire and you should get about a 2-inch spark.

Q. 2.—Will I need any impedance in series with primary? What would coil be rating in watts?

A. 2.—We hardly think it will be necessary to use an impedance in series with the primary as the coil will probably have enough impedance. This coil will take about 4 amperes on 8 volts and would consume from 35 to 40 watts.

**DYNAMO.**

(848.) Evan Feightner, Ohio, writes:

Q. 1.—Can a dynamo with a two pole

armature be used to charge small storage batteries?

A. 1.—Certainly, if the voltage is at least 20% higher than the combined voltage of the Storage Batteries.

Q. 2.—What size and how much wire should I use for the armature and field magnets of the above kind of dynamo? The armature is 2¼ inches long and 2¼ inches in diameter. The winding space on the field magnets is 2 inches long and 1¾ in diameter. Both armatures and field magnet being of cast iron.

A. 2.—We would suggest using No. 22 or No. 24 enamel wire for the armature and No. 18 wire for the fields.

Q. 3.—What would be the voltage of the above dynamo?

A. 3.—This machine would give about 8 to 10 volts.

**WIRELESS QUERIES.**

(849.) R. L. B., W. Va., asks:

Q. 1.—What size and what kind of wire to use from aerial to instruments?

A. 1.—You may use regular Aluminum wire No. 14 or any insulating wire No. 14.

Q. 2.—What size and what kind of wire to use to connect up in instrument?

A. 2.—We would suggest never to use smaller wire than No. 18 to connect up receiving instruments.

Q. 3.—How far can I send with the following instruments: E. I. Co. ½ K. W. transformer coil, E. I. Co. spark gap, E. I. Co. 1 set adjustable condensers.

A. 3.—About 50-60 miles. Range can be increased by using larger condenser and a helix.

**SENDING DISTANCE.**

(850.) H. Houston, Idaho, asks:

Q. 1.—What size of a spark coil or transformer with 5,000 feet of aerial and at a reasonable height with all necessary parts would be required for a distance of 45 or 50 miles transmitter? In my case, electricity is not available so it will require

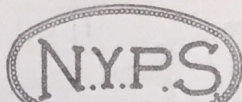

**New York Purchasing Service**

is an institution, unique in many respects from other concerns. This institution does the buying for out of town folks, in a thoroughly reliable manner. The N.Y.P.S. will **BUY ANYTHING** for you whether it is a dynamo or a brass bed, whether a harvesting machine or a piano, whether an oil painting or a bathtub, and it guarantees that it positively

**S A V E S**

you money on all your purchases. Located in New York City, the greatest commercial market in the world, the N.Y.P.S. can, thank to its long standing experience, buy cheaper and better than you, as it buys direct from the manufacturers, which saves you the middleman's and retailers profits.

Write us what you want, try us, let us convince you that we can save you from 10% to 50% **ON ALL YOUR PURCHASES.** We now have over 2000 satisfied customers on our books and save them large sums of

**M O N E Y**

every year. We would like to do the same for you; will you let us? Remember, if it's made anywhere in the world, we can get it. If it's not made, we will have it made for you and **SAVE YOU MONEY.** Suppose you sit down right now and make us prove it. A postal card will do the trick.

**New York Purchasing Service**

123a Liberty St. 161a Greenwich St.  
New York City, U. S. A.

**HOW TO RUN AN AUTO**

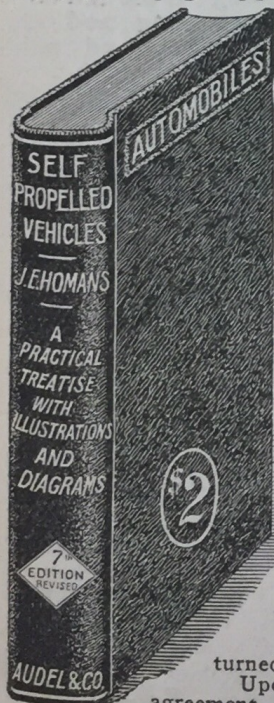

"Homans' Self Propelled Vehicles" gives full details on successful care, handling and how to locate trouble.

Beginning at the first principles necessary to be known and then forward to the principles used in every part of a Motor Car.

It is a thorough 1911 course in the Science of Automobiles, highly approved by manufacturers, owners, operators and repairmen. Contains over 400 illustrations and diagrams, making every detail clear, written in plain language. Handsomely bound.

**Price \$2.00 Postpaid**

**APPROVAL OFFER**

The only way the practical merit of this **MANUAL** can be given is by an examination of the book itself, which we will submit for examination, to be paid for or returned, after looking it over.

Upon receipt of the following agreement, the book will be forwarded.

**NO MONEY IN ADVANCE REQUIRED, SIGN AND RETURN**

**Theo. Audel & Co., 63 Fifth Ave., New York**

Kindly mail me copy of Homans' Automobiles, and if found satisfactory, I will immediately remit you \$2.00, or return the book to you.

Name .....

Occupation .....

Address ..... Modern Electrics

When writing, please mention "Modern Electrics."

a dynamo and small engine. Please state what size dynamo it will require for same "either spark coil or transformer."

A. 1.—We would suggest instead of using a dynamo to work 3 2-inch coils in series as shown in diagram. We would

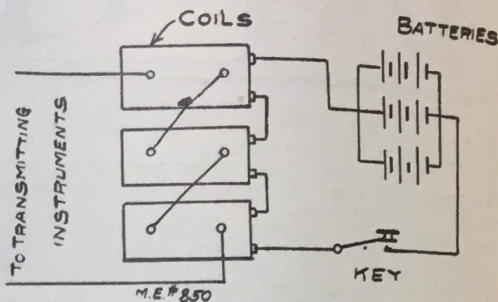

also suggest using about 20 dry cells in series multiple to work the coils. This would in all probability transmit the required distance with the large aerial you have.

**1/2-INCH COIL.**

(851.) Leon Bryant, Maine, writes:

Q. 1.—Can I receive from a boy who has a 30 foot aerial, 1/2 inch spark coil, zinc gap, key and waterpipe ground and 5 batteries with 30 ft. aerial, tuning coil 4 1/2 inches diameter by 12 inches long, wound with No. 18 wire, 2 75-ohm receivers and ground in moist earth?

A. 1.—Your question is not quite clear enough as you do not state what instruments you have. Neither do you state how far your friend lives away from you. If you will give us this information, we could tell better.

Q. 2.—What size and amount of wire is necessary for a 1/2-inch coil helix and where can it be obtained?

A. 2.—To make a helix to work on 1/2-inch coil you need about 6 turns of No. 6 aluminum wire spaced 1 inch apart. You can procure the wire from The Electro Importing Co., New York.

**10-INCH SPARK COIL.**

(852.) C. M. Capen, Mass., writes:

Q. 1.—Please give me complete data on building a spark coil using about eight pounds of No. 28 scc magnet wire. Coil to be run on 110 volts A. C. using an electrolytic interrupter.

A. 1.—Use 26 pounds No. 28 S. C. C. magnet wire. Length of core 20 inches, diameter of core 1 3/4 inches. Number of Primary wire No. 10 B. & S. 2 layers. For secondary wind 70 pies 1/8 inch thick, being careful that the winding is uniform. Insulating tube should have thickness of 3/8 inch for the wall. You should get about a 10-inch spark in connection with an electrolytic interrupter when using this coil.

Q. 2.—What would be my sending and receiving radius with the following apparatus; umbrella type aerial in attic about twenty-five feet from the ground. Sending instruments, the above coil, helix, spark gap and condenser, receiving instruments, tuning transformer, variable and fixed condensers, pair 1500-ohm phones, electrolyte and silicon detectors?

A. 2.—You should be able to send from 150 to 200 miles with this coil, and you should be able to receive at least 600 to 800 miles with your receiving outfit.

**VOLTAGE OF 1-INCH COIL.**

(853.) E. Moller, Mass., writes:

Q. 1.—What is the voltage and amperage on the secondary of E. I. Co. one inch coil run on six dry batteries; also the voltage and amperage of a Columbia dry battery?

A. 1.—The voltage of secondary is about 20,000. The amperage is too small to be considered. Columbia battery 2½ inches x 6 inches has 1.5 volts, 25-30 amperes.

Q. 2.—What is the receiving and sending distance of the following: Receiving transformer, variable condenser, fixed condenser, silicon, iron pyrites and carbon detectors and 80-ohm phones? What would it be with 1,000-ohm phones? Sending: E. I. Co. one-inch coil, helix, leyden jar condenser, key and six dry batteries. The aerial is composed of four wires, each 32 feet long, spread 39 inches apart and is 45 feet high at one end and 25 feet high at other (connections being made at lower end).

A. 2.—You should be able to receive about 200 to 300 miles with your receiving set, and you should be able to transmit 4-5 miles with your sending set. With 1,000-ohm phones, 400 miles.

**WIRELESS QUERY.**

(854.) G. S. Moon, Va., writes:

Q. 1.—Please state how I could work a wireless set over an elevation of 700 feet densely "populated" with arc lights and street car lines. I am at the bottom of this elevation and could not get more than from 75 to 100 feet of aerial on top of a four story building. The other end as you can see from the drawings below will be practically level. This distance is three miles?

A. 1.—We do not think you would have much trouble to work a Wireless Set despite the 700 foot elevation, providing you have good apparatus, which you may procure from any of our advertisers.

**WIRELESS LEGISLATION.**

(855.) Tracy M., N. J., inquires:

Q. 1.—Which is the most sensitive detector; electrolytic or perikon?

A. 1.—As far as we have been able to ascertain the electrolytic detector is by far the most sensitive one discovered as yet.

Q. 2.—Where can I buy a perikon detector and at what price?

A. 2.—Wireless Specialty Co., New York.

Q. 3.—Are any bills likely to be passed this year or next that will stop amateurs from receiving messages by wireless?

A. 3.—We do not think there is any danger at all as to any of the bills being passed, as public sentiment is against same. Besides if there should ever be a law restraining private individuals from sending, no law ever could restrain anybody from receiving messages.

**LAMP IN AERIAL.**

(856.) L. Bottom, Kansas City, Mo. writes:

Q. 1.—In using an electrolytic interrup-

**"NECO" WIRE GAUGE**

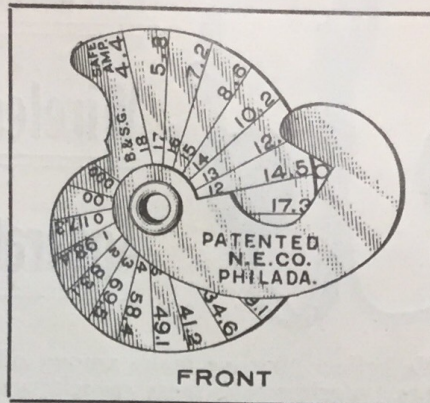

Cut is a ¾ size illustration of our IMPROVED "NECO" POCKET WIRE GAUGE, for measuring wire from No. 18 to No. 000 B. & S. gauge. On the front is also given the carrying capacity of copper wire in amperes and on the reverse side the approx. decimal equivalent of the various size wires.

Mailed to any address in the United States or Canada upon receipt of 60 cents in cash or money order.

**Novelty Electric Co.**

Manufacturers and Jobbers Electrical Merchandise

50-52-54 North 4th St., PHILADELPHIA

When writing, please mention "Modern Electrics."

**WIRELESS TRANSFORMERS**

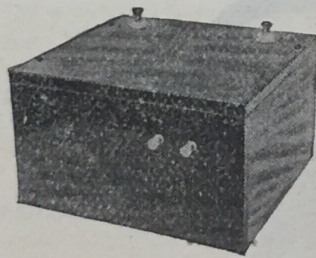

LAMINATED, CLOSED CORE, PERFECT INSULATION Maximum Power Factor.

Stamp for Leaflet

¼ Kw., \$12.00  
½ Kw., 16.00  
1 Kw., 30.00

Worts-Mckisson Mfg. Co.  
Grand Avenue. - Toledo, Ohio

When writing, please mention "Modern Electrics."

**CUTS OF SCREW MACHINE WORK**

Made to sample or Sketch

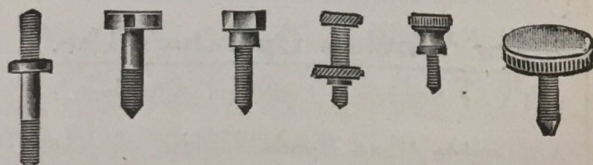

BINDING POSTS. METAL PARTS AND OTHER SPECIALTIES. MAGNET WIRE, All kinds and sizes. Send for price list.

S. M. COHN & CO.

134 Liberty Street NEW YORK

When writing, please mention "Modern Electrics."

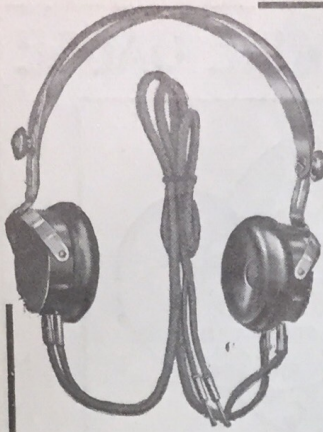

**Murdock**  
**Wireless**  
**Apparatus**

We believe that we make among other things, wireless receivers which will

**STAND COMPARISON**

with any others in use. Our belief is based on the words of satisfied patrons, and on the knowledge that we have put our best efforts into making the best. We believe that YOU would be satisfied—if you are at all particular.

Prices and description on request.

**EVERYTHING FOR WIRELESS**

**WM. J. MURDOCK CO.**

40 CARTER ST., CHELSEA, MASS.

162 Minna Street  
San Francisco

221 So. Clinton St.  
Chicago

When writing, please mention "Modern Electrics."



**HOLTZER-CABOT**  
**Receivers**

**For Wireless Operator's Use.**

(Very Sensitive — Permanent Adjustment.)

Adjustable Head Bands, (padded and pivoted.)

Pneumatic Ear Cushions.

SEND FOR BULLETIN 20 M 3.

**THE HOLTZER-CABOT ELEC. CO.**

BROOKLINE, MASS. and CHICAGO, ILL.

ter, I find that it pulls down the lights in the house. Is there any method to remedy this annoying evil?

A. 1.—You will need a choke coil as described in the June, 1910 issue of *Modern Electrics*. This will keep the lights from flickering.

Q. 2.—Why will a lamp light when placed in circuit with aerial and spark-gap?

A. 2.—The energy which is thrown upon the aerial when sending is quite powerful in some instances, inasmuch as a great deal of the energy of the coil or transformer is absorbed into the aerial, especially when leyden jars are used; there is quite a little amperage to the high tension current, which is sufficient to light up a lamp.

Q. 3.—What is the easiest way to cut out static electricity?

A. 3.—There are several methods to cut out static electricity; the best one is the so called Marconi "X"—Static-Stopper described on Page 428 of the November issue of *Modern Electrics*. We will send you this issue prepaid for 10 cents.

**UNIPOLAR TRANSFORMER.**

(857.) E. E. Baker, Newark, N. J., writes:

Q. 1.—In your issue of February, 1910, an article on a Unipolar transformer was given. Kindly tell me how to connect same with instruments. I am a reader of your magazine, which I consider the best of all the magazines I read.

A. 1.—Unipolar transformer is worked the same as any other open core transformer coil, and we give you illustration of connection below.

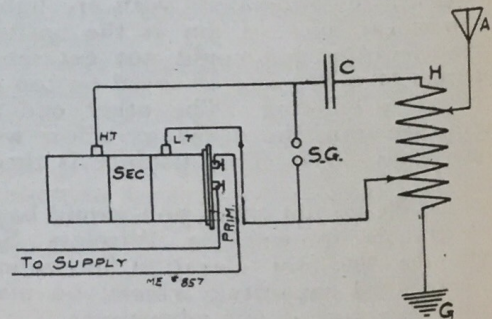

**CONDENSERS.**

(858.) W. A. Buggeln, New York City, writes:

Q. 1.—How many sheets of tinfoil should be used for a condenser across vibrator of coil giving a 3¼ inch spark, and what should the size of the sheet be?

A. 1.—150 sheets of tinfoil 7 inches x 8 inches.

Q. 2.—How should a condenser for a spark-gap be connected; across the two binding posts, or from binding post to wire leading to aerial? How large should condenser for 3¼ inch coil be?

A. 2.—The condenser for a spark-gap may be bridged direct around the spark gap. The secondary condenser for a 3¼ inch coil should have 4 glass plates, 9 inches x 10 inches and 3 sheets of tinfoil, size about 7 inches x 8 inches.

Q. 3.—How much wire would I need and of what size should it be for a helix for above mentioned coil; what size frame should I use?

A. 3.—Helix for the above coil should be made of 10 turns of No. 6 aluminum wire, convolutions 1 inch apart; diameter of the drum or cage 8 inches.

**COHERER SET.**

(859.) D. Ferritt, Pittsburg, Pa., asks:  
 Q. 1.—Would you please advise the distance that I can send with 2-inch coil, no ground wire, and an aerial only 5 feet long, to be received by Coherer and 100-ohm relay?  
 A. 1.—2 or 3 miles  
 Q. 2.—Where can I purchase a Marconi receiving outfit?  
 A. 2.—Marconi Wireless Telegraph Co., William St., N. Y.

**TRANSFORMER.**

(860.) W. R. Organ, Calif., writes:  
 Q. 1.—I built a transformer as follows; 4 layers of No. 12 on primary and 15,000 turns of 34 in secondary, wound in the usual manner. Core, laminated, 10 inches x 10 inches x 2 inches x 2 inches. I get only 1-16 inch spark, drawing five amperes. Will this transformer do for wireless work?  
 A. 1.—We are afraid there is something wrong with your transformer as you should get a longer spark. Perhaps you have not wound the secondary quite right. However, the coil will do for Wireless Work, but will hardly transmit more than 5 to 8 miles, if that much. We also think that the No. 12 wire is too heavy and if it is to be worked on 110 volts, we should say to substitute No. 18 or No. 20 wire with a sufficient amount of turns so that the transformer with a full load will not take more than 1/4 to 3/4 amperes. This would very likely give a much longer spark.  
 Q. 2.—What would be proper size capacity for it as it is, and how far would it send?  
 A. 2.—Use 20 glass plates, 10 inches x 12 inches and 19 sheets of heavy tinfoil 8 inches x 10 inches. The capacity should be about .025 microfarad.

**GAS ENGINE COIL.**

(861.) E. Johnson, Calif., asks:  
 Q. 1.—I have a Splittorf induction coil and it has an Auxiliary condenser; this coil was formerly used for a gas engine with a spark plug, and I wish you to tell me if I could use it with a Wireless Telegraph set; is there any way of finding the size of spark of this coil without having to use batteries for it is boxed completely and the Auxiliary condenser is inside. Would I need to use another condenser with the Auxiliary?  
 A. 1.—The coil which you have will give about a 3/4 inch spark as far as we can figure out, and from the information supplied by the manufacturer. You could use this for Wireless Telegraphy, but inasmuch as this coil is not made for this purpose we doubt whether you could send over 3 miles with same. It would not be necessary to use another condenser besides the auxiliary one.

**WIRELESS QUERIES.**

(862.) C. W. Schwartz, Suffield, Conn., asks:  
 Q. 1.—Will you kindly give me the re-

**The History of The Telephone**

By HERBERT N. CASSON

Author of "The Romance of Steel," etc.

WHO can deny that a history of the rise of the telephone, through untold vicissitudes to its present commercial importance, and the financial support of over a billion dollars in the United States, alone, to say nothing of the rest of the world, is interesting.

Yet in spite of our familiarity with this indispensable instrument, and our absolute dependence on it in many ways, how few of us know anything of its remarkable story.

Mr. Casson has a unique faculty of describing the evolution of commercial enterprises in such a way as to make his writing decidedly entertaining, and in "THE HISTORY OF THE TELEPHONE," he has produced a work that every one interested in electricity will find highly instructive as well.

*Profusely illustrated.* *Cloth Bound*  
 299 Pages. *Indexed.* \$1.50 net

**At All Bookstores**

OR FROM

**A. C. McCLURG & CO., Publishers**  
 NEW YORK CHICAGO SAN FRANCISCO

When writing, please mention "Modern Electrics."

**Aluminum Wire for Aerials**

If you have been using Copper or Galvanized iron Wire for your Aerial, and the snow, sleet and strong winds of the winter has broken it down—why not construct a new Aerial with our extra strong Aluminum Wire—approximately 240 feet to the pound.

Price per pound....50c. Not Mailable  
 2000 ohm Double Head Receiver complete \$4.50  
 Loose Coupled Tuning Coils .....15.00

**WIRELESS APPARATUS**

**FLETCHER-STANLEY COMPANY**

**Electric Supplies and Specialties**

32-34 Frankfort Street NEW YORK

**PATENTS**

**TRADEMARKS and COPYRIGHTS**

**SECURED OR FEE RETURNED**

**Guide Book and What to Invent**

With valuable List of Inventions Wanted sent free. **ONE MILLION DOLLARS** offered for inventions; Electrical Cases a Specialty. Patents advertised free.

**VICTOR J. EVANS & CO., Washington, D. C.**

**HYPNOTISM**

Easily learned by mail. A natural secret. Not a gift. Positively no fake. *Success Guaranteed.* Particulars absolutely free. **C. WM. RUSSELL, Dept. 7, Westchester, N. Y.**

When writing, please mention "Modern Electrics."

## IMPORTANT ANNOUNCEMENT

Owing to many improvements in our Ferron Detector together with increased cost of labor and material we find it necessary to announce an increase in price of this instrument to \$8.50 to take effect March 1, 1911.

All orders mailed on, or before that date will be filled at the old price of \$5.00. Orders sent later than March 1st will only be accepted at the new price of \$8.50.

Order at once from your electrical supply house, or from us direct and learn from results why this instrument is meeting with such a tremendous demand.

Our new catalog "L" describing equipments for both commercial and private use will be ready March 1st. Sent for 4c. stamps.

**CLAPP - EASTHAM CO.**

149 Main St. Cambridge, Mass.

When writing, please mention "Modern Electrics."

## WONDERFUL WIRELESS TELEGRAPH

With our little outfit you can send messages across a large room or from one room to another; complete with Morse Alphabet and full instructions 10cts.  
ACME MFG. CO. DEPT., H Norwalk, Conn.

## WIRELESS APPARATUS

Our Wireless goods are the best on the market, and are guaranteed to work. Our instruments are made of the finest materials, and are sold at present at a price within the reach of every experimenter. Send a 2c. stamp for our large catalogue which contains a full list of Wireless instruments, Novelties and Electrical goods, and also a great deal of Wireless information for the Wireless experimenter.

THE I. W. T. WIRELESS CO.,  
728a Broadway, Brooklyn, N. Y.

## WIRELESS APPARATUS

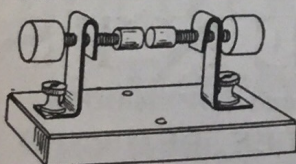

**SPARK GAPS, \$0.40 as per cut . . .**

Send stamp for Wireless Folder giving complete description of our instruments.

BAYVIEW ELECTRIC COMPANY  
4 Bayview Place, West Haven, Ct.

When writing, please mention "Modern Electrics."

## Patents 25 Years' Experience

New Easy Plan of Payment

BOOK MAILED FREE, telling all about Patents and how to obtain them. Illustrates 100 MECHANICAL MOVEMENTS, VALUABLE FOR INVENTORS.

**CHAS. E. BROCK, Patent Attorney**  
912 F Street, WASHINGTON, D. C.

When writing, please mention "Modern Electrics."

ceiving distance of the following set connected as per diagram? Double-slide tuning

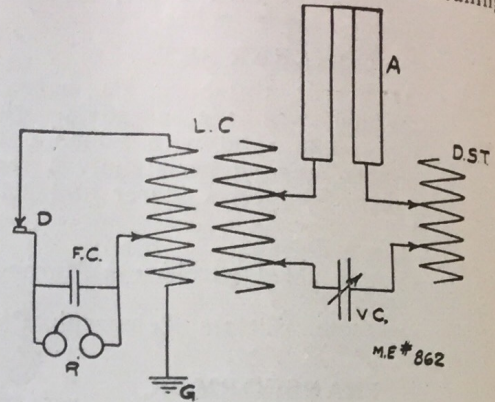

coil, double-slide receiving transformer, rotary plate variable condenser, Murdock improved silicon detector, fixed condenser and phones with a joint resistance of 4000-ohms, aerial composed of four No. 14 aluminum wires 60 feet high and 60 feet long, ground on water pipe and chicken netting in moist ground?

A. 1.—We would think that with the set which you have and the way you have it connected there should not be any trouble in receiving 500 to 600 miles.

Q. 2.—How far can I send with a 6-inch coil run from a 110 volt 133 cycles alternating current passing through an E. I. Co.'s electrolytic interrupter, a zinc spark gap, helix, tubular condensers and the same aerial and ground as above, connected as per diagram?

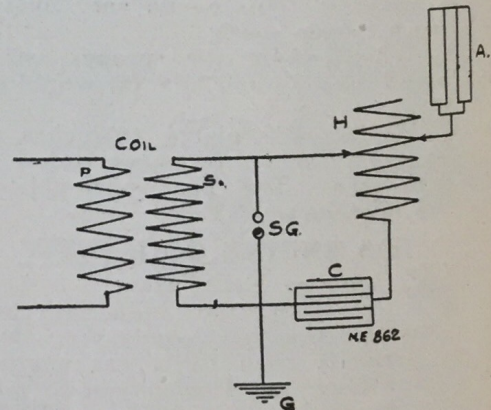

A. 2.—We think you could transmit about 40 miles and perhaps 50 with your transmitting set as described. However, we do not quite understand what you mean with tubular condensers, as tubular condensers are usually used for receiving only. You probably are referring to leyden jars.

### LARGE COIL.

(863.) A. D. Holcomb, Cedar Rapids, Ia., says:

Q. 1.—Could I boil out the discs of my coil in wax without re-winding and mount them on the tube in oil so that the oil would take the place of the wax around the tube?

A. 1.—We think the coil broke down due to straining same when you used it as a transformer. This is quite evident. We do not think it advisable to keep the old sections, but would advise you to rewind



them or else you will very likely have the same trouble over again, as, in a large coil, the current always has a tendency to pass through the weakest places. We would think the coil could be improved a great deal by placing it in oil.

Q. 2.—If so, what kind of oil could I use that will not dissolve paraffine or beeswax? I had in mind raw linseed oil, boiled to expel all moisture.

A. 2.—Use boiled linseed oil or better regular transformer oil, which you may procure from some transformer companies or from the Standard Oil Co., New York. We do not think that this oil will dissolve the paraffin or the wax.

Q. 3.—Now, would you advise me to use it as a transformer, or as a coil with interrupter?

A. 3.—We would certainly advise using your coil as a coil proper, as the strain will not then be quite so great.

**THREAD OF BINDING POST.**

(864.) Elmore C. Cramer, Ind., says:

Q. 1.—What size die will I need to cut threads like those on an ordinary battery binding post?

A. 1.—8-32 die.

A. 2.—Where is the nearest wireless station to Martinsville, Ind., of 1/2 K. W. capacity or larger, that you know of?

A. 2.—There are quite a good many amateur stations around your neighborhood, the names of which you can obtain by writing to the Wireless Association of America, New York City. Commercial Stations of high power near you are located at Chicago, Ft. Omaha and Ft. Leavenworth.

**SINGLE SLIDE TUNER.**

(865.) Clarence Bailey, Cincinnati, Ohio, writes:

Q. 1.—Would not a single-slide tuner be as efficient as a double-slide tuner if it were connected up as per diagram?

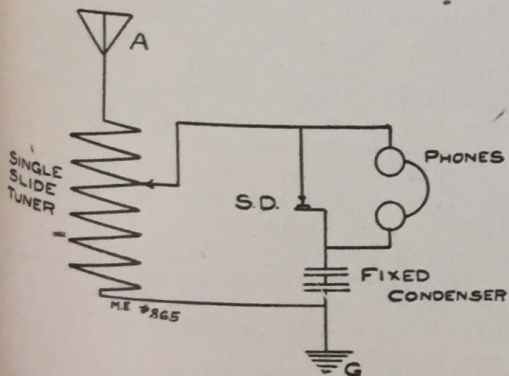

A. 1.—Single-Slide Tuning is never as efficient as a double-slide one, especially when connected as per your diagram, as ground cannot be varied.

Q. 2.—How many sheets, and what size, of tinfoil and paraffine paper will be needed to make a condenser for a silicon detector?

A. 2.—Use 10 sheets of tinfoil, size 4

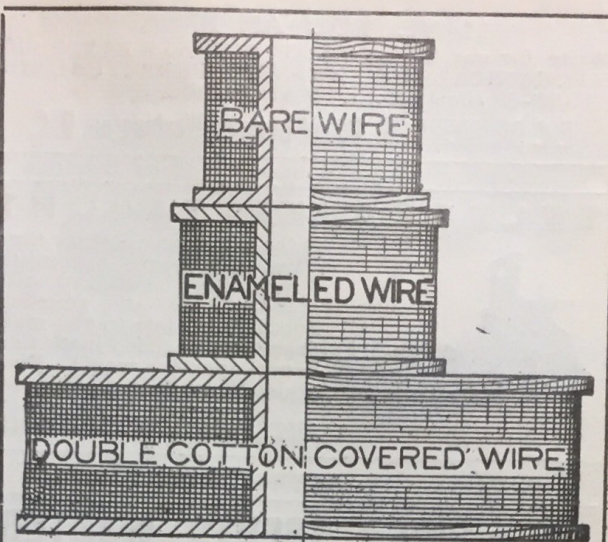

**IF YOU ARE NOT USING FEVAL ENAMELED WIRE**

on your instruments, you and your instruments suffer. Our strong, non-extravagant claim:

"The Best Enameled Wire in America"

**Féval Enameled Insulated Wire Co.**  
124a North Curtis Street  
CHICAGO, ILL.

When writing, please mention "Modern Electrics."

**MEOGRAPH**

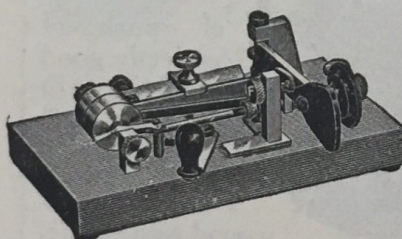

**SUPERB for WIRELESS**

The Best Telegraphic Transmitter in the World.

More MECOGRAPHS are in use than all other automatic transmitters combined

**BECAUSE:** Over 60 per cent. more movements required to send on a Morse key than on a MECOGRAPH

Holds best records for speed and long distance sending. All expert telegraphers and all bonus men use sending machines.

Operators everywhere are improving their efficiency by adopting the use of the Mecograph. Fall in line now. Eliminates glass arm.

**PRICE \$7.50**

After Nov. 1, 1910, price goes up to \$8 00. Carrying Case, \$1 00 extra. . . . Sign and mail us Coupon or our Free Catalogue.

**MEOGRAPH CO.**

321 Frankfort Ave.

Cleveland

Ohio

COUPON  
MEOGRAPH CO., 321 Frankfort Ave.  
Cleveland, O.: Please send me descriptive literature of the Mecograph.  
Name.....  
Address.....

When writing, please mention "Modern Electrics."

**HAVE YOU AN IDEA?**

Write for our books: "WHY PATENTS PAY," "100 MECHANICAL MOVEMENTS," "PERPETUAL MOTION"—50 illustrations. MAILED FREE.

F. C. DIETRICH & CO., Patent Lawyers, Washington, D. C.

When writing, please mention "Modern Electrics."

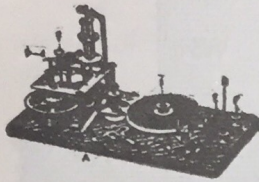
**TELEGRAPHY TAUGHT**

in the shortest possible time  
The Omnigraph Automatic Transmitter combined with standard key and sounder. Sends you telegraph messages at any speed just as an expert operator would. Five styles \$2 up. Circular free.

Omnigraph Mfg. Co.  
39½ Cortlandt St., New York

When writing, please mention "Modern Electrics."

**RIDER AGENTS WANTED**

in each town to ride and exhibit sample 1911 model "Ranger" Bicycle. Write for special offer.

We Ship on Approval without a cent deposit, prepay freight and allow 10 DAYS FREE TRIAL on every bicycle. **FACTORY PRICES** on bicycles, tires and sundries. Do not buy until you receive our catalogs and learn our unheard of prices and marvelous special offer. Tires, coaster-brake rear wheels, lamps, sundries, half prices.  
MEAD CYCLE CO. Department T-2 CHICAGO, ILL.

When writing, please mention "Modern Electrics."

**VENTRILLOQUISM****Taught Any Man or Boy**

by Mail at Home. This is no special gift as you have supposed, but an art. I have taught thousands in all parts of the world. Cost small. Send today, 2-cent stamp for particulars and proofs.

O. A. SMITH, Room 1522—823 Bigelow St., Peoria, Ill.

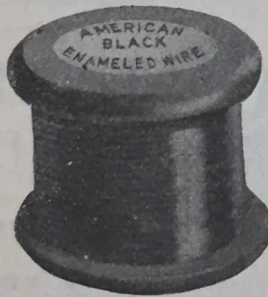
**SPECIAL**

**A** QUANTITY of spools of perfectly good ENAMELED WIRE that we will sell at a sacrifice.

This wire was wound with enamel made according to our old formula. We don't offer it as standard stock, but we do recommend it for all ordinary windings, and especially for WIRELESS WORK.

There is a good assortment of sizes.

Reservations of stock will be made in the order in which inquiries are received until stock is exhausted.

Write for prices on the sizes you need.

**American Electric Fuse Co.**

Dept. M

Muskegon, Mich.

When writing, please mention "Modern Electrics."

inches x 5 inches with thin paraffine paper between, as insulation.

**H. Q.?**

(866.) K. S. Rogers, Prince Edwards Island, Can., writes:

Q. 1.—What high power Wireless Station on the Atlantic Coast, either American or Canadian, uses H. Q. as the call letters?

A. 1.—The only registered call H. Q. we can find is the Mackinac Island Station in Michigan.

Q. 2.—I have heard it reported that the Marconi stations are using storage batteries, if so, how do they obtain the high musical note which is so easy to read through interference and Static?

A. 2.—In some of the Marconi Stations Spark coils are used having a very high tone vibrator. Also, some of their newer stations are using a singing spark which gives a very high-pitched sound.

Q. 3.—Has the Marconi Station at Cape Cod a very high and musical note to its transmitting apparatus, and do they use the American or Continental Code?

A. 3.—Yes. As far as we know Continental Code is used

**SMALL TRANSFORMER.**

(867.) E. D. Keyes, New York, writes:

Q. 1.—Referring to *Modern Electrics* "No. 12, Vol. 11, March, 1910, page 574, article, *Small Transformer*, by Louis Potter: please give data for a transformer of similar type of ½ K. W. capacity, using enclosed size of wire for secondary, to be used for wireless transmission work?

A. 1.—We would not recommend the transformer on which you ask information for Wireless Work and refer you to the September, 1910 issue, article "Construction of a Small Wireless Transformer." This will give much better service. We will gladly send you the September issue upon receipt of 10 cents.

**SPARK COIL.**

(868.) W. M. Dwyer, New Haven, Conn., writes:

Q. 1.—I have a coil with following dimensions: core one inch diameter, 10 x 4 and four layers of No. 20 copper for Primary. About 3 pounds of No. 30 for Secondary, divided into 40 layers. The coil gives but 1-16 of an inch spark. What could the trouble be?

A. 1.—We are not surprised that your coil should not give the right spark length. Your primary is constructed on the wrong plan and should be wound with No. 12 copper wire and you should not have more than 2 layers. If you will wind a new primary you will probably get the right spark length.

**75-MILE STATION.**

(869.) J. J. Mickel, Chicago, Ill., asks:

Q. 1.—Kindly let me know what equipment is necessary to install two sets of wireless; one here in the city and the other out in the country, perhaps 75 to 100 miles distant. Of course this includes both sending and receiving at each end.

A. 1.—We would recommend the following equipment:

$\frac{1}{2}$  K. W. transformer coil, zinc spark gap, large sending helix, glass plate condenser, Wireless key with heavy contacts, electrolytic interrupter, for the sending set. We would suggest an electrolytic detector, head set 2,000-ohm receivers, potentiometer, tuning coil, variable condenser, fixed condenser, and a few dry cells for receiving set. We refer you to our advertising columns for further information.

**LARGE HELIX.**

(870.) Nathaniel Hart, Conn., asks:  
 Q. 1.—What is the best size of wire to use for a long aerial and for long distance work, as I want to use copper at quite a long stretch of about 300 feet or more.  
 A. 1.—For a long stretch, we would advise using aluminum wire No. 12 as it is much easier to put up than copper and will not sag one-half as much.  
 Q. 2.—What is the best resistance for a good pair of receivers for long distance work and what is the best kind and size of wire to use on a double-slide tuning coil about  $2\frac{3}{4}$  inch in diameter and about 1 foot, 5 inches long?  
 A. 2.—In our experience, we have found that 2,000-ohms, (1,000-ohms per receiver) is the best thing to use for most Wireless purposes. The best wire to use on double slide tuning coil of the size stated is No. 24 B. & S.  
 Q. 3.—Also, please tell me the best size and kind of wire to use on a sending Helix of quite large capacity and used for sending at least 30 miles and what size coil should I have so as to obtain these results?  
 A. 3.—The best wire for a large helix would be No. O. B. & S. aluminum wire 8 to 10 convolutions, diameter of cage about 12 to 14 inches. To operate this helix, you should have a  $\frac{1}{2}$  K. W. transformer when in connection with an electrolytic interrupter.

**A MISPLACED TERM.**

(871.) E. K. Oxner, So. Boston, Mass., asks:  
 Q. 1.—If I am running a  $\frac{1}{4}$  K. W. transformer (closed core) of 110 volts A. C. current and have a rotary spark gap with 6 movable electrodes and one stationary one, driven at a speed of 600 R. P. M., am I obtaining synchrony in the two circuits, primary and secondary? If the 110 V. A. C. is 60 cycle? In a dispute over the question, A. says no, B. says yes, as the interruptions of the spark and the complete alternations of the primary current are the same per minute. By "synchrony" I mean the same effect as if the spark gap were placed on A. C. generator shaft, which, of course, is impossible in our case, city current being used.  
 A. 1.—We do not see the sense of the question as we do not see what good it would do even if you had as many interruptions in your spark gap as cycles of the alternation current. The term "synchronism" applied to your question is not correct.

**DYNAMO FOR ARC LIGHT.**

(872.) G. E. T., Willow Hill, Ill., writes:  
 Q. 1.—Will you please tell me, through

**Wireless Transformers and Induction Coils**

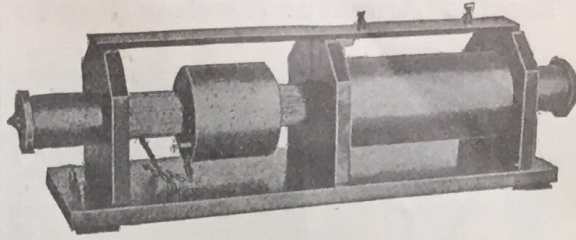

$\frac{1}{2}$  K. W. Transformer complete **\$30**  
 with Condenser and Spark Gap  
 This is something new. Send for Catalog and Prices  
**E. S. RITCHIE & SONS**  
 115 Cypress St., Brookline, Mass.

When writing, please mention "Modern Electrics."



**CAN YOU BEAT THIS?**

2000 Ohm set

**\$4.50**

**I say you can't**

Better than anything on the market at this and even at a higher price.

**Let us prove it**

Receiver only, 1000 Ohms,

**\$1.50**

Postage 10c.

**C. BRANDES, 111 Broadway, New York**

When writing, please mention "Modern Electrics."



The Wireless Association of America, headed by America's foremost wireless men, has only one purpose: the advancement of "wireless." If you are not a member as yet, do not fail to read the announcement in this issue. *No fees to be paid.*

**WANTED-IDEAS**



Manufacturers are writing me for patents procured by my clients. Protect your ideas! Send for free 72 page book "Successful Patents" and "Stepping Stones" (containing over 200 inventions wanted). Personal services. Clients patents advertised and sold free.

**R. B. OWEN**

DEPT. 7

**WASHINGTON, D. C.**

When writing, please mention "Modern Electrics."

**"Electro" Amateur Wireless Phones**

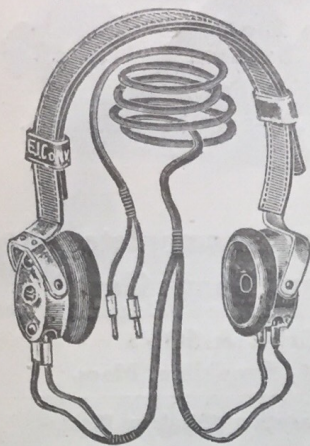

We herewith present our new amateur type wireless phones which are superior to anything as yet. Our No. 1305 phones which are in use now by the United States Government, Marconi and the United Wireless Co.'s are of course of higher grade but our new phones are in every respect built as carefully, the only difference being that the finish is not so elaborate. These phones have 1000 ohms each receiver and are wound with **No. 50 single silk covered wire.** These phones have double pole magnets which are extremely

powerful and made especially for wireless. The head is **adjustable and leather covered,** and impossible to catch your hair. The receivers fit the head perfectly. The weight is 15 ounces. With this set we furnish a beautiful six foot green cord with nickel plated tips. The phones are made with swivel arrangements which make good fit possible. A test will convince you that our phones are superior to any other make and we shall be pleased to send you a set of these phones on receipt of \$1. deposit, with privilege to inspect same. If not satisfactory we shall refund the money.

**No. 8070** two thousand Ohm phones as described complete

**\$4.50**

By mail extra 22 cents, packed in box. Send 2c. stamp for our new 196 page wireless cyclopedia No. 9, containing lots of information on wireless, diagrams, etc.

**ELECTRO IMPORTING CO.**

"EVERYTHING FOR THE EXPERIMENTER"

233-w Fulton Street  
New York

When writing, please mention "Modern Electrics."

**PATENTS**  
THAT PROTECT AND PAY

Books, Advice, Search and List of Inventions Wanted **FREE.** Send Sketch or Model for Search. Highest References. Best Results. Promptness Assured.

**Watson E. Coleman, Patent Lawyer**  
622 F ST. N. W. WASHINGTON, D. C.

When writing, please mention "Modern Electrics."

**WIRELESS CODES.**

LETTERS	MORSE	CONTINENTAL	NAVY
A	·—	·—	·—
B	—···	—···	—···
C	—·—·	—·—·	—·—·
D	—··—	—··—	—··—
E	·	·	·
F	··—·	··—·	··—·
G	—·—	—·—	—·—
H	····	····	····
I	···	···	···
J	·—··	·—··	·—··
K	—·—	—·—	—·—
L	··—·	··—·	··—·
M	—··	—··	—··
N	··—	··—	··—
O	—··	—··	—··
P	··—·	··—·	··—·
Q	—··—	—··—	—··—
R	··—·	··—·	··—·
S	····	····	····
T	—··	—··	—··
U	··—·	··—·	··—·
V	····	····	····
W	··—·	··—·	··—·
X	··—·	··—·	··—·
Y	··—·	··—·	··—·
Z	··—·	··—·	··—·
1	·—··	·—··	·—··
2	··—·	··—·	··—·
3	··—·	··—·	··—·
4	··—·	··—·	··—·
5	··—·	··—·	··—·
6	··—·	··—·	··—·
7	··—·	··—·	··—·
8	··—·	··—·	··—·
9	··—·	··—·	··—·
0	··—·	··—·	··—·

ABBREVIATED NUMERALS USED BY CONTINENTAL OPERATORS:  
1-10

WIRELESS ABBREVIATIONS:  
C.E. - GOOD EVENING 4 - PLEASE STAY HE-HE-HE  
C.N. - NIGHT 13 - UNDERSTAND  
C.S. - MORNING 15 - AM BUSY NOW  
C.A. - GO AHEAD 30 - NO MORE  
C.B. - SHIP REPORT 33 - BEST REGARDS  
C.L. - FIRST MESSAGE 77 - MESSAGE FOR YOU  
C.M. - MESSAGE 88 - DELIVERED  
C.R. - OPERATOR 89 - KEEP OUT  
-DISTRESS SIGNALS  
S.O.B. MORSE C.G.D. CONTINENTAL

This Beautiful Code Chart printed on heavy cardboard is the finest in existence.

Size 9 x 11 Inches

Just what you need in your station, Morse, Continental and Navy Codes, Abbreviations, Calls, etc.

Price 10 Cts.

BY MAIL EXTRA .03

Modern Electrics Publication  
233 Fulton St., New York

the "Oracle," what size dynamo it would take to light an arc for a motion picture machine? Also what horse-power gasoline engine? Would want some power to spare to run front display about 20 16-C. P. incandescents.

A. 1.—You will need a gasoline engine giving about 2 to 3 H. P. and a small dynamo giving at least 50 volts and 3 amperes. If you would wish to run about 20 16-C. P. lamps at the same time with the arc lamp, the dynamo should necessarily give about 15 amperes.

**FLAMING ARC LAMPS.**

BY MOORE STUART.

If an arc between ordinary carbons is drawn farther apart than from 1/8 to 1/4 of an inch, additional current is required to maintain the arc and but very little more light is given off. However, if carbons are impregnated with certain salts of minerals, the mineral is evaporated by the heat of the arc and makes the otherwise non-luminous flame of a drawn-out arc intensely brilliant. With these impregnated carbons the arc may easily be drawn out from 3/4 to 2 inches, although it must be understood that it will take more current, the longer the arc. The one drawback to the flaming arc is that it cannot be enclosed in the same sense as the arc between plain carbons, on account of the ash and slag and production of fumes. Flaming arcs are usually designed so as to feed both carbons down instead of one up and one down as in the older type of common arc lamps. The flame is also blown down by means of a strong electro-magnetic field across the path of the arc. In this way the light from the intensely hot electrodes is also utilized. The arc is partly surrounded by a small shield of a special grade of porcelain called an "Economizer" which protects the arc from drafts of air as well as serving to reflect the light downward.

Some flaming arcs use a lower electrode of pure copper and the upper one a tube containing mineral salts and powdered metallic substances. These lamps are arranged in the same manner as the ordinary carbon lamps, but are used for direct current only on account of the great arcing qualities of this current.

**SPECIAL COMBINATION OFFER OF WIRELESS STOCKS**

One share MARCONI WIRELESS of America, par value .....	\$25.00
One share MARCONI WIRELESS of Canada Par value .....	5.00
One share MARCONI WIRELESS of England, Common, Par value .....	5.00
One share MARCONI WIRELESS of England, Pref. (dividend paying), Par value .....	5.00
Total four (4) shares (Par value \$40.00), cash with order, all for.....	\$25.00

P. C. KULLMAN & CO.

The Wireless Brokers, 68 Wall St., New York.

When writing, please mention "Modern Electrics."

**PATENTS**

**C. L. PARKER**

Ex-Examiner U. S. Patent Office  
**PATENT LAWYER**  
8 McGill Bldg., Washington, D. C.

**PATENTS, TRADEMARKS, COPYRIGHTS, PATENT LITIGATION**  
Handbook for Inventors. "Protecting, Exploiting and Selling Inventions" sent free upon request.

When writing, please mention "Modern Electrics."

**PATENTS SECURED OR FEE RETURNED**  
**Guide Book and What to Invent**

With valuable List of Inventions Wanted sent free. **ONE MILLION DOLLARS** offered for one invention; \$16,000 for others. Patents secured by us advertised free in World's Progress. Sample free.

**VICTOR J. EVANS & CO., Washington, D. C.**

When writing, please mention "Modern Electrics."

**LEARN TO BE A WATCHMAKER**



**Bradley Polytechnic Institute**  
Horological Department A  
Peoria, Illinois

FORMERLY PARSONS HOROLOGICAL INST

**Largest and Best Watch School in America**

We teach Watch Work, Jewelry, Engraving, Clock Work, Optics. Tuition reasonable. Board and rooms near school at moderate rates. Send for Catalog of information.

When writing please mention "Modern Electrics."

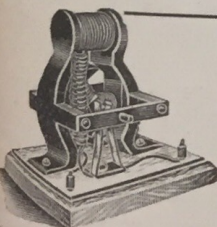

**The White Eagle Electric Motor**

Postpaid, 75c.

We make working models of inventions. Send for illustrated catalogue of Model Supplies.

**THE PIERCE MODEL WORKS**  
Industry B'g., 85 5th Ave., Chicago

When writing, please mention "Modern Electrics."

**LEARN CHIROPRACTIC**  
**The new method of drugless healing**  
**EARN \$50 TO \$100 PER WEEK**

Our free book tells how you can learn to detect disease and remove the cause by Howard's method of Spinal Adjustment. Positively the most simple, direct, advanced and scientific method of drugless healing. Based on unerring natural laws. Anyone can understand it; learned in spare time. Improve your social prominence and financial standing. Start now on the road to honor and success. Write for free book and special scholarship offer.

**NATIONAL SCHOOL OF CHIROPRACTIC**  
800 Wendel Bank Building, Chicago, Ill

When writing, please mention "Modern Electrics."

**PATENTS**

No attorney's fee until patent is allowed.  
Write for "Inventor's Guide."

**FRANKLIN H. HOUGH,**  
Loan and Trust Bldg., Washington, D. C.

When writing, please mention "Modern Electrics."

**Typewriter Sacrifice Sale**

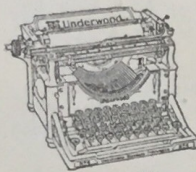

Greatest bargains ever offered. **Underwoods, Oliviers, Remingtons, Smiths,** (All makes) rebuilt \$15 to \$38, worth double; sent subject to examination and trial.

Send for "Bargain List"

(OLD RELIABLE)

**Consolidated Typewriter Exchange**

245 Broadway, New York

Established 27 years on Broadway. Don't miss this chance to get a good typewriter at half price. Write immediately.

When writing, please mention "Modern Electrics."

**NEED A SWITCH OR A COIL?**

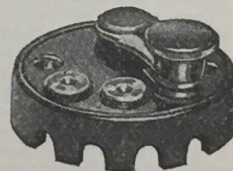
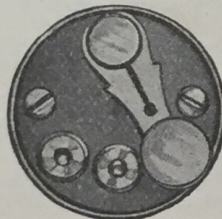

The ACME switch is just the thing for **WIRELESS** work. The lever is removable, so that no one can tamper with your outfit.

We can also make you **ROCK BOTTOM** prices on **COILS**. Write **TO-DAY**.

**SWITCH** sells at 50c.; **COILS** \$2.50 up.

**ACME PARTS CO.**

Lafayette, Ind.

When writing, please mention "Modern Electrics."

**Faucet WATER MOTOR**

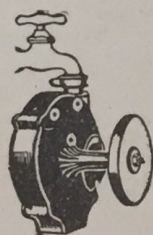

Complete with emery wheel **\$2.50** buff wheel, pulley to run sewing and washing machine, polish. In some cities where we have no agents, and where the water pressure is good, a **sample motor** will be given free; apply at once if you want to make some extra money, or if you can devote your whole time, liberal salary and commission will be paid.

**ALCOHOL STOVES, LAMPS AND FLAT IRONS**

**ENGINEERS WANTED** to send for catalog of indicators. Reducing Wheels Planimeters. Address.

**LIPPINCOTT M. S. CO.**

52 Columbia St.,

Newark

New Jersey

When writing, please mention "Modern Electrics."

**CLASSIFIED ADVERTISEMENTS**

Advertisements in this column, 2 cents a word, no display of any kind. Payable in advance. Stamps not accepted. Count 7 words per line. Minimum, 2 lines. Heavy face type 4 cents a word. Minimum, 3 lines.

Advertisements under "Wireless" 5 cents a word. Minimum, 4 lines. Wireless books and blue prints not listed under "Wireless," 2 cents a word.

Advertisements for the March issue must be in our hands by Feb. 25.

**ELECTRICAL APPARATUS**

**STUDY ELECTRICITY AT HOME.** A complete electrical course at home, containing 30-page detail book, 220-page text-book, 200 page experiments and over 100 pieces of apparatus. Price, complete, only \$5.60. Catalogue "M. E. S." explains this and other remarkable offers. Thomas M. St. John, 848 Ninth Ave., New York.

**SMALL MOTOR PARTS:** Sixteen slot drum armature spider ready for wire core and winding, shaft and eight bar silver commutator with two brass collector rings, complete with diagram and directions, thirty-five cents. With directions for complete motor, fifty cents. Commutator alone, twenty cents. Postage prepaid. May be used as direct or alternating current synchronous motor or rotary converter. Capacity twenty-five to thirty watts. Fine for that rotary spark gap. Address Motor, Box 15, East Pittsburg, Pennsylvania.

When writing, please mention "Modern Electrics."

**ELECTRICAL BOOKS, BLUEPRINTS, ETC**

**OPERATORS** Wireless Telegraph and Telephone Hand-book. Most up-to-date treatise yet published. Prepaid \$1.00. Arthur Reed, 25 Bellevue Place, Chicago.

**LIGHT YOUR HOME** with four dry batteries. New system. Send 10c. for blueprint and details. W. L. Booth, Pullman, Wash.

**LEARN MAGIC.** Three card tricks, 10 cents. Klein, 1193 Broadway, New York.

**HYPNOTISM.** By mail full course, 25 cents. Klein, 1193 Broadway, New York.

**PUBLICATIONS:** "Keen Knowledge." Annual subscription 25c. Quarterly, 10c. Palmland, Brokaw Ave., Floral Park, N. Y.

When writing, please mention "Modern Electrics."

**WIRELESS****WIRELESS FIENDS.**

Phosphor Bronze Aerial Wire as used by Government, the best yet. Just imported 25,000 feet. 1½ cts. per foot. Bornite and Zincite, the most sensitive combination, 50 cts. per set. Zincite and Copper Pyrites, 50 cts. per set. Silver plated brass cup for mounting crystals, 10 cts. each. Sliders (for square rod ¼-in. x ¼-in.) with ball and spring, 20 cts. complete. Black Asphaltum, Black and White Shellac, liquid ready for use, large bottle, 25 cts. Spool containing 1000 Ohms No. 50 Copper Wire, 60 cts. Silicon or Molybdenite, large piece, 15 cts. Send postage stamp for 128 page Catalog.

Attention Wireless Experimenters. We have the best assortment of wireless instruments in Detroit. We keep everything in stock, no delay. Send 2 ct. stamp for catalog. Seidler, Miner Electric Co., Detroit, Mich.

Wireless fiends save freight and expressage. Why order from the East if you can secure ALL wireless goods on the Coast? We carry largest assortment of wireless apparatus in Frisco. Can make prompt shipments. Call or send postage for catalog. Paul Seiler Electric Works, Market street, San Francisco, Cal.

When writing, please mention "Modern Electrics."

All wireless goods and supplies carried in stock. Most complete assortment in St. Louis. You save money by dealing with us, and you get the most up-to-date instruments. A call will convince you. Stamp for catalog. Hance Electric Co., Olive street, St. Louis, Mo.

**HEAVY** paper tubes for wireless workers. All sizes in stock. Prompt shipment. Twenty-five cents a foot (all diameters) postage paid. Maroc Machine Company, 8 Western Avenue, Lowell, Mass.

**COMPLETE LONG DISTANCE WIRELESS RECEIVING SET** with double-pole 1,000 ohm receiver, \$5.95. Complete two mile sending set, \$7.95. 1,000 ohm guaranteed receivers, \$1.75. Slider rod \$.10 a foot. Sliders, \$.12, with knob \$.22. Send stamp for circulars. Alden Wireless Co., Dept. M., Campello, Mass.

**FOR SALE:** Special—A limited number of 1 inch, 2 inch and 4 inch Special Wireless Coils, wound with Enameled wire. Address Vergil Morris, Elizabethtown, Ind.

**IRON PYRITES**, known as Ferron, also Finest Pyron. Ferron crystals 15 cents, pyron 50 cents each, thoroughly tested.

**OUR NEW LINE.**— C. C. Brandes famous 'phones. Finest in the world. Write for prices. Crystal Co., 1120 Avenue C, Flatbush, L. I.

When writing, please mention "Modern Electrics."

**FOR SALE**

**FOR SALE:** 1 K. W. closed core transformer, \$25. Almost new and in good condition. No resistance or interrupter needed. Efficiency 92%. D. W. Pinkerton, 2510 Parkwood Ave., Toledo, O.

**FOR SALE:** Clapp-Eastham closed core transformer ¼ K. W., \$15; new, used short time only; regular price \$26. Elmer Lamb, 1990 Erie Street, Toledo, Ohio.

**EXTRAORDINARY OFFER**—Must sell quick brand new Queen Co. 4-Rumpkoff coil; beautifully finished in hard rubber, mahogany. Regular \$40.00 coil. Used one week for testing purposes. No further use for same. Now \$15.00 Wireless Operator, 47 Pierpont St., Brooklyn, N. Y.

**FOR SALE:** \$4.50, receiving set worth \$10.00. J. J. Healy, 314 9th St., Hoboken, N. J.

**FOR SALE:** 1¼ in. spark coil, two double slide tuning coils, one E. I. Co. potentiometer, 4 electrose insulators, one pair 2,000 ohm receivers with leather head-band and pneumatic ear cushions; one 6 v. 25 h. storage battery. Will sell for \$15.00. Jos. Rachor, 120 S. Duncan St., Baltimore, Md.

**FOR SALE:** 1 tuner, 1 Silicon detector, 1 zinc spark-gap, 1 12-glass plate sending condenser, 1 fixed condenser, 1 marble switch-board with two double throw switches. Price \$500. Edgar C. Boydston, Douners Grove, Illinois.

**FOR SALE:** 1 1-K. W. closed core transformer, 1 key, 1 condenser. All new. \$25.00. Ralph Terry, Lowell, Wisconsin.

**FOR SALE:** ½ K. W. direct current dynamo. 110 v. 4 amp. In perfect condition. Irving Patridge, Milbank, S. D.

**FOR SALE:** One complete wireless receiving and sending station. Walter Dziadik, 130 Main St., Derby, Conn.

**FOR SALE:** Powerful 2 in. spark coil, without vibrator, \$7.00. Pair 2,000 ohm phones \$4. L. W. Davis, 36 Auburn St., Concord, N. H.

When writing, please mention "Modern Electrics."

# "How to Make Wireless Instruments"

BY 20 WIRELESS EXPERTS

## A NEW WIRELESS HANDBOOK

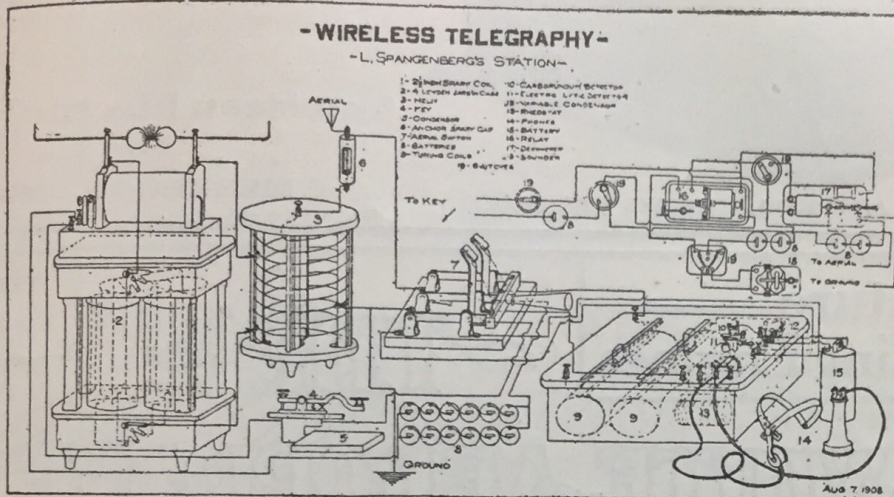

96 Pages

CONTENTS

75 Illustrations

- How to make a loose coupler.
- How to make a microphone detector.
- How to make a simple antenna switch.
- How to make a spark gap muffler.
- How to make a 1000-ohm relay.
- How to make a carborundum detector.
- How to make a bare point electrolytic detector.
- How to make a selective tuner with weeding out circuit.
- How to make a coil vibrator attachment.
- How to make an electrolytic detector.
- How to suspend and insulate aerials.
- How to make an iron pipe aerial.
- How to make a tantalum detector.
- How to make a small transformer.
- How to make a transmitting helix.
- How to make a potentiometer.
- How to make an interrupter and detector combined.
- How to make an electrical resonance apparatus.
- How to make a wireless without aerial.
- How to make a talking condenser.
- How to make a two-mile wireless station.
- How to make a tuning coil.
- How to make a silicon detector.
- How to make the simplest and most efficient wave detectors.
- How to operate a wireless by speech only.

Our new book is the only one of its kind, and contains more information on the construction of wireless instruments and apparatus than any book ever published —no matter what its price.

It contains description of twenty-five different pieces of apparatus, each fully illustrated. Clear photographs of the actual apparatus, diagrams, dimensions and sketches of the necessary pieces will be found in great profusion.

The contents were taken from articles published in the first volume of MODERN ELECTRICS. All were carefully re-edited, and most of them re-illustrated with new, clear sketches, etc.

A book that every experimenter and amateur in the wireless art must possess.

Ready for delivery now. Send money or express order, or coin. Stamps and checks not accepted.

Price, Twenty-Five Cents, Prepaid.

Modern Electrics Publication,

233 FULTON STREET  
NEW YORK

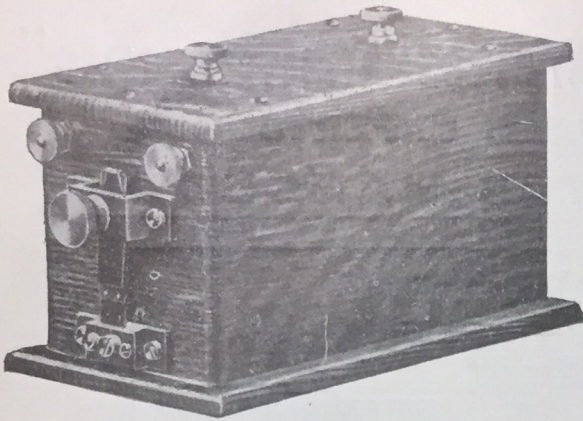

TYPE W AMERICOIL—THROWS 5-IN. SPARK

# WIRELESS COILS

For a 2-Cent Stamp we will send you our brand new AMERICOIL Catalog, entitled WHAT'S IN A COIL AND WHY.

**American Electric Fuse Co.**

DEPT. C

MUSKEGON, MICH.

## Miniature Gasling Engines

FOR MODELS



Send for our 16-page complete catalogue of aeroplanes, wheels, balls, turnbuckles, thrust bearings, sockets, propellers and supplies for models. Mailed on request.

# THE WHITE AEROPLANE CO.

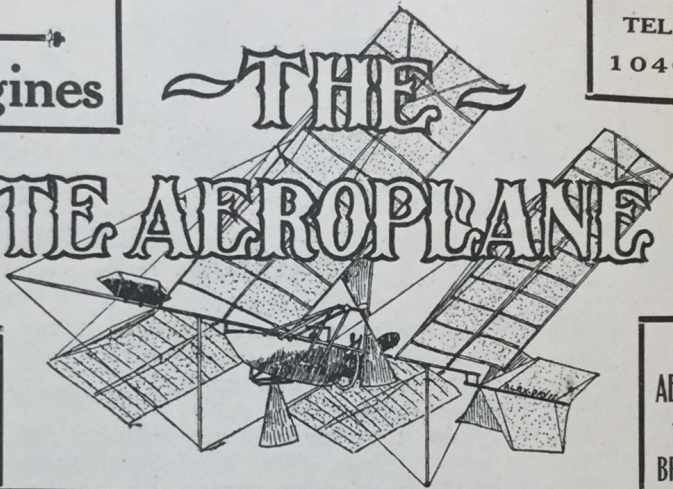

TELEPHONE  
1040 MAIN

WHITE  
AEROPLANE CO.  
15 Myrtle Ave.  
BROOKLYN, N. Y.

## METAL E. KONIG'S LOW STAMPING & TOOL WORKS CLEVELAND, O. STAMPING DIE MAKERS. HARDWARE SPECIALTIES

### USE ISOMETRIC DRAWING

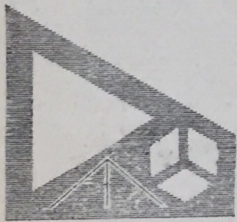

The Isograph  
Celluloid, 6 x 5 inches

The Isograph makes it easy. Illustrate your ideas and make your working drawings explain themselves. For dimensional or free hand work. Illustrated book of instructions quickly teaches the amateur. Invaluable to inventors. Cuts down experimental work and may save making a model. Its time-saving features are indispensable to the professional. Every worker in wood or metal needs an Isograph. Carpenters builders and sheet metal workers use it constantly. It explains your most complicated ideas.

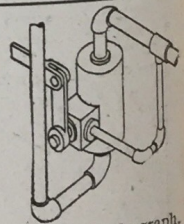

Postpaid with book of instructions 50c., Money Order or 2c. stamps. Send to-day.

Made with the Isograph. Gives 3 views in one. As good as a photograph.

THE ISOGRAPH CO., 147 E. 23d St., New York City

## — 1911 JUST OFF THE PRESS 1911 —

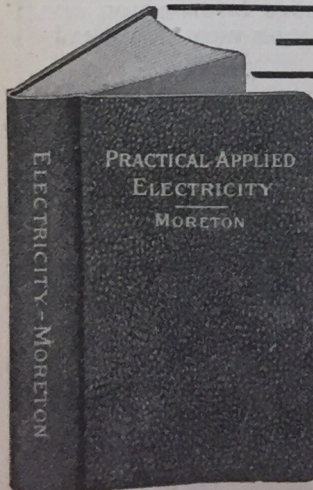

### Practical Applied Electricity

By DAVID PENN MORETON, B.S., E.E.  
Associate Professor of Electrical Engineering at  
Armour Institute of Technology.

Over 300 pages, 200 detailed line drawings, diagrams and descriptions. Bound in Black Seal Flexible Leather. Front and Back stamped in Gold. Round Corners. Red Edges. Just fits the Pocket. Price \$1.50. Sold by Booksellers and Supply Houses throughout the English speaking world.

The author of this book has taught the subject for many years, and has been able to present the subject to his students without the use of much mathematics. A book in simple language, adapted both for those engaged in advanced electrical work. No other book on the market like this one.

**THE CHARLES C. THOMPSON CO., CHICAGO**

545-549 Wabash Ave.

PUBLISHERS



The Second Annual Official

# Wireless Blue Book

READY NOW

The only book of this kind in existence. In three parts:

- U. S. Land Stations (also Canadian Stations).
- U. S. Ship Stations (including foreign ships touching U. S. ports).
- U. S. Amateur Stations.

The book is arranged in such a manner that ALL calls are classified ALPHABETICALLY. Therefore, no matter from what part of the country or the sea, the wireless call comes, you will immediately locate the sender.

This book is the most complete one of wireless stations published and is warranted to be the most accurate one in print. No more guesswork.

In addition we furnish a

## WIRELESS MAP OF THE U. S.

in three colors, size 13 x 9½, which can be mounted or hung in your station. Gives location and distances for all Government and Commercial stations in the United States, and ENABLES YOU TO COMPUTE QUICKLY DISTANCES, WHEN TRACING A CERTAIN CALL.

YOU CANNOT AFFORD TO BE WITHOUT THIS BOOK.

**PRICE BY MAIL, 15c.**

Cash or Stamps (only U. S.—no foreign ones) taken

MODERN ELECTRICS PUBLICATION :: 233 Fulton St., New York

When writing, please mention "Modern Electrics."

## Here is the Standard Reference Work on Electricity

and we want you to examine it absolutely free of charge in your own home or office. Read our Liberal Selling Plan—it tells how we will send you the great six-volume

### CYCLOPEDIA OF Applied Electricity

upon receipt of the coupon and allow you to examine it free of charge.

We have confidence in this great cyclopedia; we know that it is the reliable authority on electricity. It is compiled from the instruction papers of the American School of Correspondence, written by thirty of the world's greatest electrical experts. We want you to endorse our claims and for this reason we make you this free offer.

If you want to be an expert—an authority on everything electrical, you need a work that covers every phase of electrical engineering—a work that will tell you what you want to know in plain English without technical terms and formulas. That is just what you have in this cyclopedia. These books cover every branch of electricity thoroughly, exhaustively, from the elements of electricity to the design and construction of power and central stations. Read "Important Subjects Covered," and then mail the coupon. The six volumes contain 2,896 pages, 7x10 inches in size; 2,000 special illustrations, photographs, plates, diagrams, tables, etc., beautifully bound in half morocco; titles stamped in 23-karat gold.

#### This is Our Liberal Selling Plan.

prepaid, for 5 days' free examination. If you decide to keep the books, send us your initial payment of \$2.00 within five days and \$2.00 every month until you have paid the special price of \$18.80. The regular price is \$36.00. If, after thoroughly examining the books, you do not see your way clear to keep them, notify us and we will send them at our expense. Send the coupon today.

#### IMPORTANT SUBJECTS COVERED

of Dynamos and Motors; Elevators; Direct-Current Motors; Electrical Measurements; Electric Management of Electric Railways; Alternating Current Motors, etc.; Electric Welding; Mercury-Vapor Con- Design; Storage Batteries; Power Transmission; Electric Wires; Electric Telegraph; Telephone; Automatic Telephone; Wireless Telephony, etc.

short time we will include as a monthly supplement, for one year, the TECHNICAL MAGAZINE. This is a regular \$1.50 monthly, full of Twentieth Century scientific news in popular form. Also contains the latest discussions on timely topics in inven- tory, industry, etc.

AMERICAN SCHOOL OF CORRESPONDENCE, CHICAGO, U. S. A.

Mod  
El.2-11  
A. S. of C.  
Please send set Cyclopedia of Applied Electricity for five days' free examination, also Technical World for one year. I will send \$2.00 within 5 days and \$2.00 a month until I have paid \$18.80, or notify you and hold the books subject to your order. Title not to pass until fully paid.

NAME .....

ADDRESS .....

OCCUPATION .....

REFERENCES .....

When writing, please mention "Modern Electrics."

# NEW PREMIUMS

We offer below a new assortment of premiums any one of which may be obtained by a little extra effort. You read Modern Electrics, which means it must be good, then show it to your friends. Help us, and help yourselves. You don't have to be a subscriber to take advantage of this chance to obtain a valuable instrument for nothing; it takes just a few minutes of your time. Get the subscription, send it to us and we will forward by return mail the premiums you select. Your own (new) subscription will count. Now get busy and get a practical present FREE.



Junior Fixed Condenser.

Used in all modern receiving sets. Special dielectric giving extra high capacity. Sealed in hard rubber base with binding posts, as shown. Sells for \$0.50.

(Add 6 cents for postage)

Given free for one subscription



Electric Scarf Pins. Many unique Styles. Fitted with cord and plug, and attachable to any flashlight by removing the lamp. Scarf Pin sells for \$0.45.

(Add 4 cents for postage)

Given free for one subscription

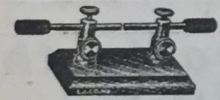

Zinc Spark Gap mounted on hard rubber base. Electrodes fitted with rubber handles. Pure zinc rods. Used in all of the best stations. Spark gap sells for \$0.60. Add 7 cents for postage.

Given free for two subscriptions

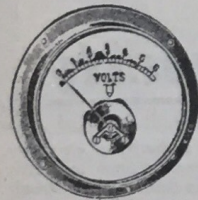

Voltmeter or Ammeter, 1-12 volts 1-15 amperes. 2 1/2-inch face, heavily nicked and reliable. Dead beat, a first-class instrument. These meters sell for \$2.00.

(Add 7 cents for postage)

Given free for five subscriptions

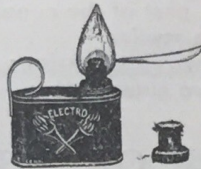

Automatic Blow Torch.

The handiest torch made. Gives a solid blast of flame for soldering purposes, without any artificial blowing. The very latest. Torch sells for \$0.35. (Add 10 cents for postage)

Given free for one subscription

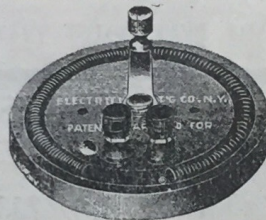

"Electro" Rheostat. Rotary adjustment. Air cooled. Very useful to vary the speed of motors and small lamps. Wound

with non-rusting wire.

Given free for one subscription



"Electro" Medical Coil. All quality. No end of fun with one of these coils, besides its therapeutic properties. Complete with cords and handles. Medical Coil sells for \$0.70. Add 12 cents for postage.

Given free for three subscriptions



"Electro" Amateur Phones, 2000 ohms resistance. Wound with No. 50 copper wire. Thin diaphragms. Leather covered adjustable headband. Weight 15 oz. 80 per cent. better than 75 ohm phones. Phones sell for \$4.50. Add 25 cents for postage.

Given free for ten subscriptions



The "Electro" Flaming Pocket Lighter. Lights your cigars anytime. Fits in the vest pocket. It sells for \$0.35.

Given free for one subscription

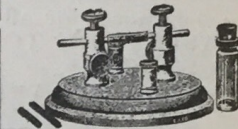

"Telim" Auto Coherer. HARD RUBBER BASE. Needs no decoherer.

Complete with two carbon plugs, one iron plug, graphite-carbon grains and bottle of mercury. Auto-Coherer sells for \$0.80. Add 15 cents for postage.

Given free for two subscriptions

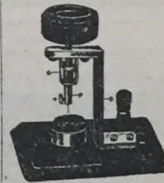

"Electro" Lytic Bare Point Detector. Holds the world's record for long distance receiving. Mounted on hard rubber base. Finest adjustment. Increase your receiving range 30 to 40 per cent.

"Electro" Lytic Detector sells for \$1.25. Add 12 cents for postage.

Given free for three subscriptions

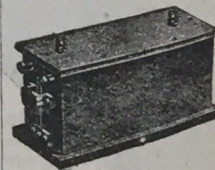

One Inch Spark Coil. This is the coil that has sent a message 90 miles with a suitable aerial. None better made. High speed French vibrator. Sells for \$4.50.

One inch coil. Sent by express only.

Given free for 12 Subscriptions

We are sure you can get any of the above premiums, if you show this Magazine to your friends. They will want it right away. Then's your chance, nab 'em! before the other fellows get 'em. Strike while the iron is hot. Act now. Don't delay. You won't get this chance again.

Send money orders or N. Y. Drafts, no checks or stamps.

## Modern Electrics Publication

233 FULTON STREET

NEW YORK CITY

# “Construction of Induction Coils and Transformers”

Compiled and arranged by H. Winfield Secor.

100 Pages. 72 Illustrations.

A New Hand-Book Giving Detailed Instructions and Data on the  
Construction of Induction Coils and Wireless Transformers

## CONTENTS

The Induction Coil, its history and theory.  
Coil Construction.  
Secondary Coil impregnation.  
The Induction Coil as a means of amusement.  
Electric Stars.  
Interruption.  
How to build an efficient Spring Vibrator.  
Construction of an Independent Vibrator.  
Simple Wehnelt Interrupter.  
An Adjustable Impedance Coil.  
A Tesla Coil.  
A Tesla Disruptive Coil.  
Air Insulated Tesla Coils.  
A large Demonstration Tesla Coil.  
Experimenting with the Tesla Coil.  
The High Tension Transformer  
How to build one-half to 3-kilowatt Closed Core Transformers.

## APPENDIX

Table of Spark Coil Dimensions one inch to twenty inch.  
Table of Spark Coil Dimensions one inch to twelve inch, heavy spark.  
Table of Spark Coil Dimensions one-quarter inch to ten inch with enamel wire secondaries.  
Table of Dimensions of open and closed Core Transformers  $\frac{1}{2}$  to 3 K. W.  
Table of Glass Plate Condensers, for Transformers up to 5 kilowatt and spark coils 1 inch to 12 inch.  
Table of Sparking Distances for various voltages.  
Inductivities of Dielectrics and method of finding condenser capacity.  
Tables of turns per inch and feet per pound of insulated magnet wire.  
Table of Soft Iron Core Weights.  
Tables giving the cost of wire, raw material, etc.

## Price, Twenty-five Cents, Prepaid.

You cannot afford to be without this book, the very latest on the construction of any size induction coil or high potential transformer for use in wireless telegraphy or X-ray work.

Its 96 pages are brim full of live, useful, up-to-the-minute information that you have been wanting for a long time; profusely illustrated with 72 clear drawings especially made for this work, and an APPENDIX of valuable tables which alone are worth the price we ask for the book.

As we expect an exceptional demand for this very timely book, by a writer whose ability is already well known to MODERN ELECTRIC'S readers, it will be wise to order now, so that you don't get left. Order at once, to-day, before you forget it; to-morrow never comes.

## READY FOR DELIVERY NOW.

Send money or express order, or coin. Stamps or checks not accepted.

MODERN ELECTRICS PUBLICATION, 233 Fulton Street, New York City

# THE WIRELESS TELEPHONE

By H. GERNSBACK

80 Pages . . . . 57 Illustrations

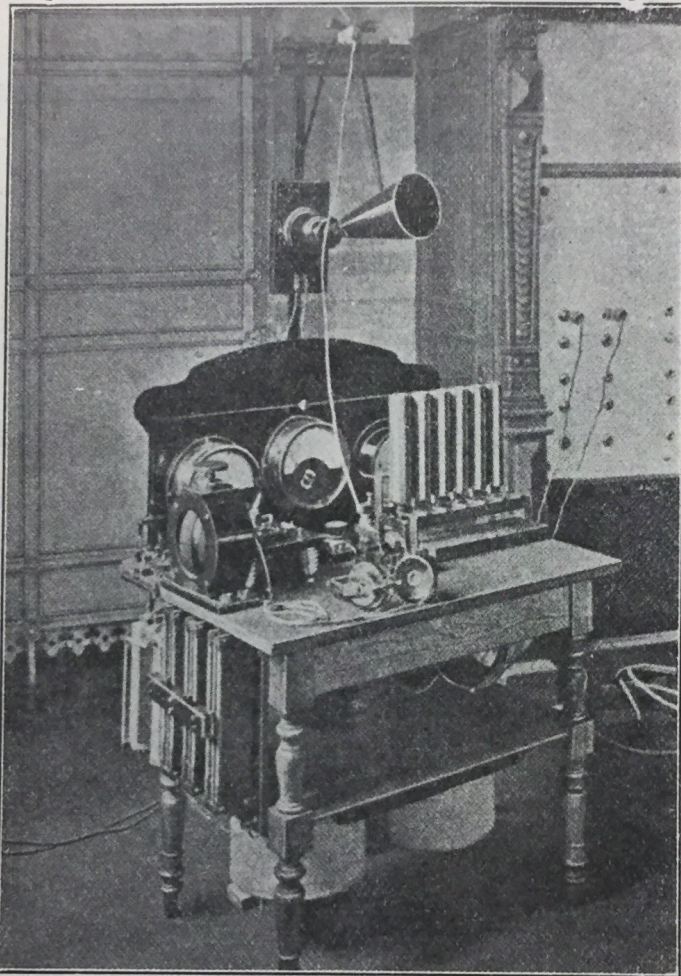

A WIRELESS TELEPHONE STATION

**T**HIS NEW BOOK, by Mr. Gernsback, stands in a class by itself.

It not alone describes the most important systems, but treats the subject from the experimenter's standpoint, in such a manner that even the less advanced student will have little trouble to clearly grasp the matter.

The book is the most up-to-date one and contains a digest of all the latest patents on wireless telephony, both in the United States and abroad.

This book is an absolute necessity to the rising wireless experimenter who desires to keep abreast with the progress of the new art, that will within five years, revolutionize telephone communication.

This book also contains directions for building small wireless telephone stations at a cost under five dollars for short distances up to one mile.

It had been our intention to sell this book for \$1.00 on account of its great value, but we believe that the demand will be so great for Mr. Gernsback's book that the low price at which it is sold, will repay us in time.

As we expect several thousand orders, it will be wise to order at once, so you will not be delayed.

**Price Twenty-five Cents Prepaid**

CLOTH BOUND, FIFTY CENTS

Send money or express order or coin, stamps or checks not accepted

---

**MODERN ELECTRICS PUBLICATION**

233 FULTON STREET, NEW YORK CITY

# HIGHEST CLASS OF MOLDED ELECTRICAL INSULATION

## 1 Shellac Composition

—black—brown—Mica; substitute for hard rubber.

## 2 Sternoid

We are the **Pioneers** in this country of **Heat-proof Electrical Molded Insulation.**

### CLAIMS

500° F. without softening.  
A perfect insulator.  
Non-Hygroscopic.  
High mechanical resistance, can  
be tapped or drilled.  
Metal parts can be molded in.

## 3 Stern-BAKELITE

Heatproof — splendid for high tension, line and overhead insulation.

**PRACTICALLY UNBREAKABLE**

We solicit your correspondence—blue prints, models

**DICKINSON MANUFACTURING CO.**

KURT R. STERNBERG

Treasurer and General Manager

**SPRINGFIELD, - MASSACHUSETTS**

J. H. PARKER, Sales Agent

No. 6 Hawley Street, Boston, Mass.

# Four Extraordinary Offers

To make February our banner subscription month, we are willing to make the following **FOUR WONDERFUL OFFERS**.

Frankly, we would like to see your name appear among the 51,000 readers, who now are regular subscribers, and in order to do so, we are willing to go to an **EXTRAORDINARY EXPENSE**, never before attempted by any magazine.

### OFFER NO. 1.

Send us \$1.00 cash, stamps, or money order, and in return, we will send you:

- 1—Modern Electrics for one year (February issue free) ..... \$1.00
- 2—Book, How to Make Wireless Instruments, cost ..... .25
- 3—Book, The Wireless Telephone, by H. Gernsback, cost ..... .25
- 4—Book, Construction of Induction Coils and Transformers, by H. W. Secor, cost.. .25

Total..... \$1.75

(If books are to be mailed add 6c. postage)

**TOTAL NET SAVING..... .75**

### OFFER NO. 3.

Send us \$1.00 cash, stamps, or money order, and in return, we will send you:

- 1—Modern Electrics for one year (February issue free) ..... \$1.00
- 2—Linen Binder (automatic) holds 12 issues M. E., gold stamped..... .50
- 3—Any one of the 3 books shown in offer No. 1..... .25

Total..... \$1.75

(Mail charges for Items 2 and 3, 15c. extra.)

**TOTAL NET SAVING..... .75**

### GREAT WIRELESS OFFER NO. 2.

Send us \$1.00 cash, stamps, or money order, and in return, we will send you:

- 1—Modern Electrics for one year (February issue free) ..... \$1.00
- 2—Wireless Code Chart, cardboard; size 9x12 in., Morse, Navy and Continental codes ..... .10
- 3—Wireless chart with 20 Wireless Standard "Hook-ups" ..... .10
- 4—Join the Wireless Association of America, and Wireless Pin ..... .20
- 5—Official Wireless Blue Book, 32 pages, and 13x10 in. chart of U. S. stations..... .15
- 6—Any one of the 3 books shown in offer No. 1..... .25

Total..... \$1.80

(Mail charges for Items 2, 3, 4, 5, 6, 8c. extra.)

**TOTAL NET SAVING..... .80**

### OFFER NO. 4.

Send us \$1.00 cash, stamps, or money order, and in return, we will send you:

- 1—Modern Electrics for one year (February issue free) ..... \$1.00
- 2—12 back numbers of Modern Electrics, all consecutive numbers, all in good condition, each 10c. .... 1.20

Total..... \$2.20

(No mail charges necessary.)

**TOTAL NET SAVING..... \$1.20**

The offers as shown must not be changed nor can articles from any one offer be exchanged with any article of another offer. The selection is quite complete and we are positive that you will find a suitable offer among the four. **IMPORTANT:** For Manhattan and Canada, add 25c.; Foreign, 50c.

**Modern Electrics Publication 233 Fulton Street, New York, N. Y.**

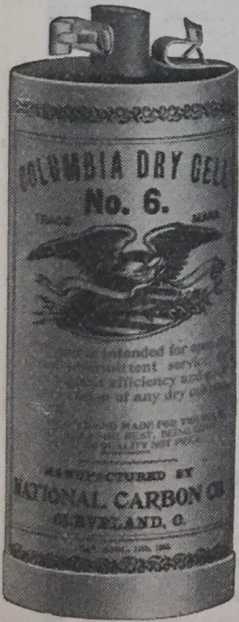

## THE BEST

# COLUMBIA DRY CELL

will last longer and give better results than any other dry cell known when used for general purposes.

Specially good for telephones, door bells, electric clocks, experimental work, wireless telegraph instruments, small motors and other similar devices.

Just the thing for the new stunts you are getting up or for your electrical toys. Buy them at your dealers.

**National Carbon Co., Cleveland, O.**

## Something New in Insulators

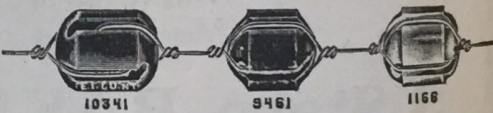

We present herewith our new departure antenna insulators which we are now offering in place of our regular antenna insulators, No. 10001.

They have the distinct advantage that there are no hooks to break out, and even if the insulator would be smashed, which is almost impossible, the aerial wires could not fall, because the loops of both antenna and support wires would hold each other.

These insulators are beautifully finished and have the highest insulating qualities. They will not leak any more than any good insulator, have a fine appearance, and are the lowest priced on the market.

**No. 9461** is made of brown, TRIPLE glazed porcelain, size 2 1-4 x 2 1-2 in., weight 12 oz., for receiving only. Price 10 cents. Per doz., \$1.15.

**No. 1166** is made of glass entirely, the most beautiful insulator ever made. Size 2 1-4 x 2 1-2 in., weight 11 oz., for receiving only. Price each 12 cts. Per doz. \$1.35.

**No. 10341** (patent applied for). This insulator is made of the same material as No. 9461. It is longer and heavier. Its body is pierced by two round holes, through which the wire loops pass. **For sending up to 2-in. spark length.** Will not leak. By placing several of these insulators in series, large spark coils or transformers can be operated without fear of leakage. Size 3 x 2 1-4 in., weight 14 oz. Price each 16 cts. Per doz. \$1.85.

Send 2c. stamp for our new 128-page wireless "encyclopedia" No. 7, containing lots of information on wireless diagrams, etc.

**ELECTRO IMPORTING CO.**

"EVERYTHING FOR THE EXPERIMENTER"

233-z Fulton Street  
New York

When writing, please mention "Modern Electrics."

When writing, please mention "Modern Electrics."

# The Greatest Magazine Bargains

We Save You As Much As 40 Per Cent. On Your Subscriptions

MODERN ELECTRICS.....	\$1.00	<b>OUR PRICE</b> <b>\$3.00</b>
COSMOPOLITAN (or American, or Good Housekeeping)	1.50	
REVIEW OF REVIEWS.....	3.00	
Regular Price, -		\$5.50

Modern Electrics.....	\$1.00	
World's Work.....	3.00	
Everybody's.....	1.50	
Delineator.....	1.00	
Regular Price, -		\$6.50

**Our Price**  
**\$4.05**

Modern Electrics.....	\$1.00	
Pearson's.....	1.50	
Leslie's Weekly.....	5.00	
Regular Price, -		\$7.50

**Our Price**  
**\$5.40**

Modern Electrics.....	\$1.00	
Good Housekeeping.....	1.00	
The Outlook.....	3.00	
Regular Price, -		\$5.00

**Our Price**  
**\$4.25**

Modern Electrics.....	\$1.00	
Review of Reviews.....	3.00	
McClure's Magazine.....	1.50	
Woman's Home Companion....	1.00	
Regular Price, -		\$7.00

**Our Price**  
**\$4.20**

Modern Electrics.....	\$1.00	
Pictorial Review.....	1.00	
Cosmopolitan, (or American or Good Housekeeping).....	1.50	
Regular Price, -		\$3.50

**Our Price**  
**\$2.15**

Modern Electrics.....	\$1.00	
The World Today.....	1.50	
Pearson's.....	1.50	
Regular Price, -		\$4.00

**Our Price**  
**\$2.40**

## MODERN ELECTRICS IN CONNECTION

	REGULAR PRICE	OUR PRICE		REGULAR PRICE	OUR PRICE
With Ainslee's.....	\$2.80	<b>\$1.85</b>	With Motor Boat.....	\$3.00	<b>\$2.30</b>
" American Boy.....	2.00	<b>1.45</b>	" The Musician.....	2.50	<b>1.80</b>
" The Book-keeper.....	2.00	<b>1.45</b>	" North American Review...	5.00	<b>4.30</b>
" Cosmopolitan.....	2.50	<b>1.50</b>	" The Outlook.....	4.00	<b>3.50</b>
" Cycle & Automobile Trade Journal	3.00	<b>1.80</b>	" Pacific.....	2.50	<b>1.80</b>
" Farm Journal.....	2.00	<b>1.45</b>	" Pearson's.....	2.50	<b>1.50</b>
" Fruit Grower.....	2.00	<b>1.35</b>	" Pictorial Review.....	2.00	<b>1.50</b>
" Good Housekeeping.....	2.25	<b>1.70</b>	" Popular Magazine.....	4.00	<b>3.00</b>
" Gunter's Magazine.....	2.50	<b>2.00</b>	" Recreation.....	4.00	<b>3.00</b>
" Harper's Magazine or Weekly	5.00	<b>4.30</b>	" Review of Reviews.....	4.00	<b>2.30</b>
" Bazaar.....	2.00	<b>1.50</b>	" Scientific American.....	4.00	<b>3.30</b>
" Judge's Weekly.....	6.00	<b>5.90</b>	" Telephony.....	4.00	<b>2.30</b>
" The Ladies World.....	1.50	<b>1.10</b>	" Suburban Life.....	4.00	<b>3.05</b>
" Leslie's Weekly.....	6.00	<b>5.00</b>	" Success.....	2.00	<b>1.50</b>
" Lippincott's.....	3.50	<b>2.50</b>	" Sunset.....	2.50	<b>1.30</b>
" McClure's Magazine.....	2.50	<b>1.80</b>	" Travel.....	2.50	<b>1.80</b>
" Metropolitan.....	2.50	<b>1.75</b>	" Women's Home Companion.	2.50	<b>1.80</b>
" Modern Priscilla.....	1.75	<b>1.30</b>	" The World Today.....	2.00	<b>1.40</b>

Canadian and Foreign Postage to be added to above prices.  
We will gladly quote on any Magazine combination not listed above.  
Prompt and careful service assured.

It is impossible to get the Magazines quoted in our list cheaper elsewhere.

MAIL ALL ORDERS TO

**Modern Electrics Publication**

233 FULTON STREET

NEW YORK

PROTECT YOUR IDEA!

# Patents THAT Pay

"MY TRADE-MARK"

"Your business will have my personal attention.—" E. E. V.

## \$ 180,340.00 \$

MADE BY MY CLIENTS

YOU SHOULD Have My FREE BOOKS  
Telling HOW OTHERS will do the  
same IN THE FUTURE "WHAT  
and HOW to INVENT" BOOK  
FREE

**FREE**  
**TWO BOOKS:**  
61-Page  
"Inventor's Guide"  
AND  
64-Page  
"Proof of Fortunes  
in Patents—  
What and How to  
Invent."

**FREE**  
The above - entitled  
books will tell you How  
to Secure Money to "Pat-  
ent" Your Invention,  
How to Sell Your Patent,  
and ALL about the  
**Great Success  
of My Clients**

Trade-Marks, Copyrights,  
Prints, Labels, Registered.  
**ADVICE FREE.**  
Correspondence Solicited.

### REFERENCES

- American National Bank  
Washington, D. C.
- Little Giant Hay Press Co.  
Dallas, Tex.
- Gray Lithograph Co.  
New York City, N.Y.
- Farmers Mfg. Co., Norfolk, Va.
- New Era Mfg. Co.  
Fairfield, Ia.
- The Parry Stationery Co.  
Oklahoma City, Okla.
- Bell Show Print Co.  
Sigourney, Ia.
- The Camp Conduit Co.  
Cleveland, O.
- The Iowa Mfg. Co.  
Oskaloosa, Ia.
- Sam'l Allen & Son Mfg. Co.  
Dansville, N.Y.
- The Garl Electric Co.  
Akron, O.
- Superior Mfg. Co.  
Sidney, O.
- Tidnam Tel. Pole Co.  
Oklahoma City, Okla.
- Bernhard Furst  
I. Austria-Hungary
- Compound Motor Co.  
Brooklyn, N.Y.

I advertise my clients' patents free in a magazine having a two million circulation.

**MY FEE RETURNED IF "PATENT" IS NOT ALLOWED**

(SEE ABOVE LIST OF REFERENCES—THEY TALK!)

**HIGH CLASS WORK EXCELLENT TESTIMONIALS**

SUCCESSFUL CLIENTS IN EVERY SECTION OF THE U. S.

Expert-Prompt Services

Highest References

809 F. ST., N. W.

**E. E. VROOMAN,** Registered Patent Attorney  
Patent Litigation  
PATENT LAWYER

**Wash., D.C.**

My offices are located across the street from the U. S. Patent Office.

When writing, please mention "Modern Electrics."

## Wireless Spark Coils

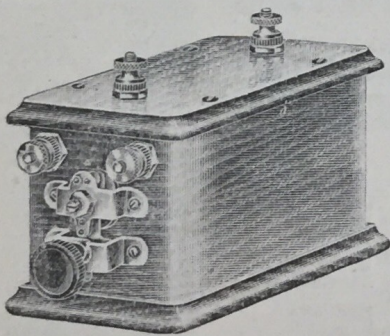

1/4 inch and 3/8 inch Type

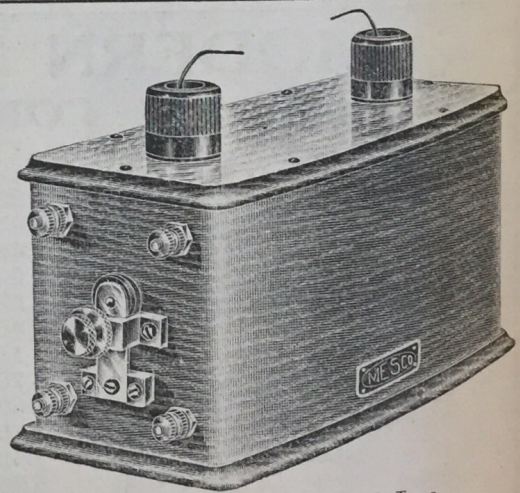

3 inch and 4 inch Type

The large and increasing demand for **MESCO** wireless spark coils proves our claim that **they have no equal.** They are underrated in regard to spark length. Many of our one-inch coils will give spark 1 3/4 inches long. The current consumption is low, a good one-inch spark being produced on a consumption of 1 1/2 amperes. Our manual of Wireless Telegraphy and catalog No. C1, describing a full line of high grade wireless apparatus will be mailed to any address.

Insist on Getting



Apparatus



**Manhattan Electrical Supply Company**

NEW YORK, 17 Park Place. CHICAGO, 188 Fifth Ave.

When writing, please mention "Modern Electrics."





# Will YOU Be Ready When YOUR Chance Comes?

Will YOU be chosen as the right man when the big opportunity comes? Are YOU better prepared to rise from the ranks than the men beside you?

Could you fill satisfactorily a position requiring knowledge of "hows" and "whys"? Could you direct the work of others so as to get the best results? Would any employer be safe to trust your planning and figuring and doing?

To make it short, have you any special equipment? Is there anything in you to command big pay?

Through the study of I. C. S. Courses, shop hands have become draftsmen, foremen, and superintendents; carpenters and masons have made themselves contractors, architects, or structural engineers; clerks have advanced to high-salaried places as advertising men, window trimmers, show-card writers, or chemists; farmers' sons have mastered electrical or civil engineering; miners have qualified for positions as inspectors, superintendents, or mining engineers; young men have prepared for Civil Service positions, or studied successfully surveying and mapping, illustrating and designing, automobile running, sanitary plumbing, textile work, navigation, or some other occupation covered by one of the 214 Courses of the I. C. S.

It will cost you nothing but postage to learn all about the salary-raising plan of the I. C. S.

**Mark and Mail the Coupon NOW**

**International Correspondence Schools  
Box 992, Scranton, Pa.**

Please explain, without further obligation on my part, how I can qualify for a larger salary and advancement to the position, trade, or profession before which I have marked X.

Electrical Engineering  
 Electric Lighting  
 Electric Railways  
 Electrician  
 Electric Car Running  
 Dynamo Foreman  
 Dynamo Tender  
 Wireman  
 Mining Engineer  
 Telephone Expert  
 Civil Engineer  
 Automobile Running

Mechanical Engineer  
 Mechanical Draftsman  
 R. R. Constructing  
 Concrete Construction  
 Architect  
 Contracting and Building  
 Architectural Draftsman  
 Plumbing & Heating  
 Chemist  
 Bookkeeper  
 Advertising Man  
 Civil Service Exams.

Name \_\_\_\_\_

St. & No. \_\_\_\_\_

City \_\_\_\_\_ State \_\_\_\_\_

Present Occupation \_\_\_\_\_

# 1911

## Annual "Odd-Coil" Sale

We make the broad statement that during 1910 we have sold more spark coils for wireless and experimental purposes than all other electrical concerns combined, and we challenge anybody to disprove this statement.

There is a very good reason that we do such an extraordinary large volume of business in spark coils, namely: WE MAKE THE FINEST COILS IN THE U.S. Our coils size for size are more efficient than any other make. Our coils advertise themselves and at an average each coil we sell, sells two new ones, as its enthusiastic owners are not backward to recommend them widely.

Our coils have NEVER DISSAPOINTED anybody. Out of 1000 coils not over five prove defective within one year from the sale, and these defects are usually traceable to misuse, abuse, etc.

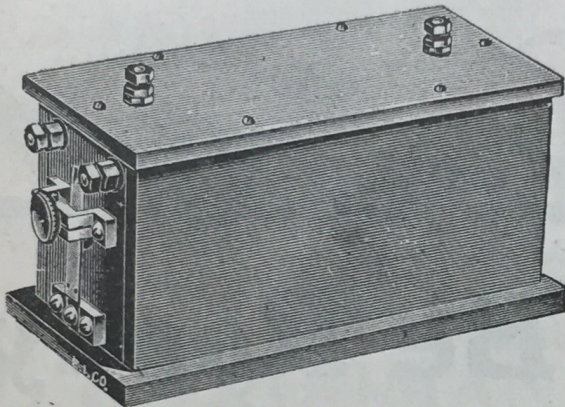

### ALL OUR COILS ARE GUARANTEED FOR ONE YEAR

and we will replace any coil proving defective within that period.

During the course of the year we collect a certain amount of ODD LENGTH-SPARK, spark coils and as we do not list these in our catalogue we offer them at greatly reduced prices to readers of MODERN ELECTRICS.

We absolutely guarantee the spark length of all coils as listed below and shall ship any coil C. O. D. with privilege of examination on receipt of one-third of its cost. This gives you an opportunity to test the coil and make sure that the claims we make are true in all respects.

No. 1087a. 1/2 in. 3/4 in. coil, uses 4-5 dry cells. Usual price, \$4.00.

Now \$3.25

No. 1088a. 1 in. 1 1/4 in. coil, uses 6 dry cells. Usual price, \$5.50.

Now \$4.75

No. 4366a. 1 1/2 in. 2 in. coil, uses 6-8 dry cells or 6 volt storage battery. usual price, \$9.00.

Now \$7.00

No. 1089a. 2 in. 2 1/2 in. coil, uses 8 volt battery. Usual price, \$13.50.

Now \$10.00

No. 1089b. 2 1/2 in. 3 in. coil, uses 8-10 volt battery. Usual price, \$18.00.

Now \$13.00

No. 1090a. 3 in. 3 1/2 in. coil, uses 8-10 volt battery. Usual price, \$25.00.

Now \$18.75

NOTICE. As we expect a large amount of orders on these special coils, sold at such ridiculous prices, your orders should be placed at once. We ship within 48 hours and usually within 24 hours after receipt of order.

This chance comes but once a year, therefore don't delay, remember, each coil is fully guaranteed.

## Gernsback Relays

Patented December 20th 1910

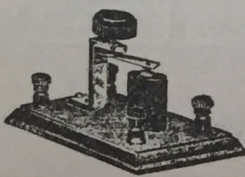

If you wish a fine relay, having extraordinary sensitivity micrometer adjustment, use the Gernsback relay, on account of its novel design and its great simplicity. It is by far the cheapest relay on the market to day. It was constructed mainly for wireless work, but, can of course be used for all other purposes where an extremely sensitive relay with fine adjustment is needed.

Base is of quartered oak, size, 5 1/4 in. x 3 1/2 in., metal parts are of lacquered brass, 4 hard rubber binding posts. Relay weighs 6 ounces.

No. 1107.	Gernsback relay 20 Ohms.	1.10
No. 1108.	50	1.10
Ny 1109.	75	1.25

By mail extra each, 14 cents

## Junior Phones

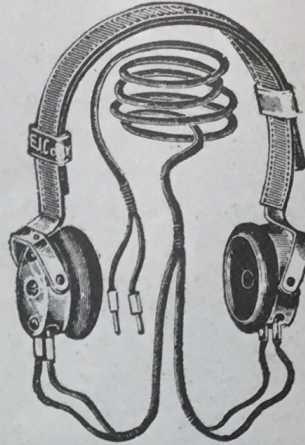

These phones are in all respects the same as our famous AMATEUR PHONES except that they have single pole phones. The resistance is 2000 Ohms, 1000 Ohms each phone. The windings are of No. 40 B. & S. enameled wire guaranteed, NOT German silver wire, as some of our competitors use.

The double headband is leather covered and there are two nickel plated clips to hold the two bands together, we furnish a fine green, six foot cord with six tips as shown.

It is a greatly mistaken idea, to think that single pole phones are not efficient for wireless work, and while we do not recommend single pole phones for long distance work, i.e. over 350 miles, they will prove highly efficient for distances under 350 miles, especially in connection with crystal detectors. We guarantee our Junior Phones in all respects and you will find them to be a much better set than you expected, per set, complete.

\$3.50

By mail, extra 25 cents

## 6 Volt 60 A.H. Storage Battery



This battery is too well known now to deserve special mention. It has been on the market for six years, and is used by several leading automobile concerns, as regular equipment.

This battery is guaranteed in all respects, its capacity is guaranteed, although we sell it as a 6 volt battery, it really shows 6.6 volts.

Each cell has 5 plates, 15 plates in all. Automatic hard rubber vent, lead covered terminals to safe guard against corrosion, steel carrying handle, impregnated oak case, Size, 6 1/2 in. x 7 1/4 in. x 7 in., weighs 25 lbs. This battery is absolutely "fool proof" and there is nothing to get out of order. Any garage will recharge it for from 25 to 35 cents, or you can recharge it yourself from your D. C. lighting supply at a cost of less than 10 cents.

On account of over production during December, this fine battery is sold at a reduced price during this month. A chance you will get but once a year.

No. 555. 6 V., 60 A. H. "Electro" Storage Battery.

\$7.35

Regular price, \$8.00

This Battery is shipped, fully charged now

# Bargains

## Just Off the Press Cat. No. 9

Below we show a few of the new things in Catalogue No. 9. If you have not already received a copy of this 196 page book, send 4c. postage TO-DAY. **Greatest Assortment of Wireless Goods in the United States.**

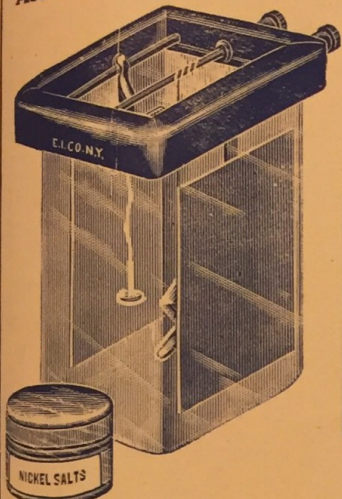

**NICKEL PLATING OUTFIT.** The neatest thing ever placed on the market. Do your own nickel plating and make money by nickel plating for others. Works on 2-3 wet batteries. Complete outfit with salts, anodes, etc..... **\$2.25**

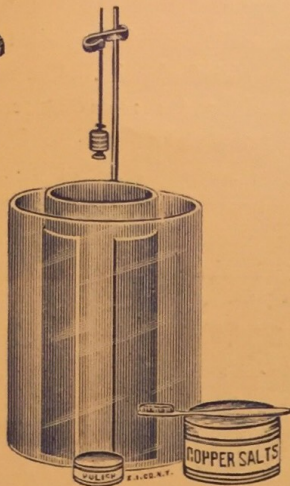

**COPPER PLATING OUTFIT.** Requires No Batteries. You can copperplate beetles, lace, metal parts, flowers, etc., with this fine outfit. Unmatched for simplicity and efficiency. Price..... **\$1.50**

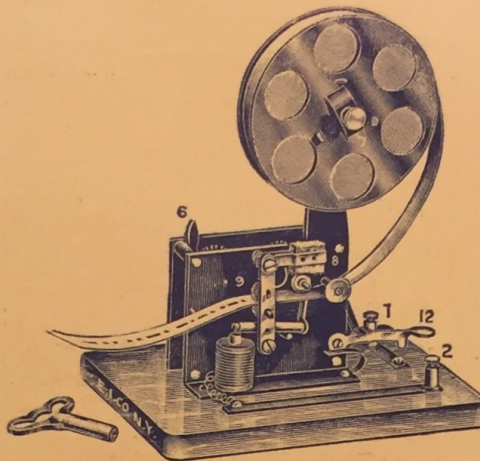

**TAPE REGISTER.** This is IT. You have wanted this long. A perfect little outfit. Size 5 1/4 x 4 x 7. Has automatic ink wheel, paper reel just like the commercial article. Works on one dry cell. For use with coherer outfits and regular telegraph work. Is equipped with telegraph key. Price..... **\$3.50**

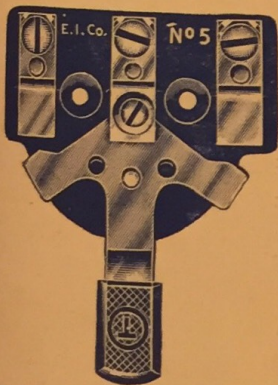

**BABY SWITCHES.** This is our new line of composition rubber base switches, finest made in the country. No 5 especially recommended for Detector switch, neat and small. No. 5, D. T. S. P., each... **26c**  
By mail extra 4c.  
No. 1, S. P. S. T., each... **16c**  
By mail extra 3c.

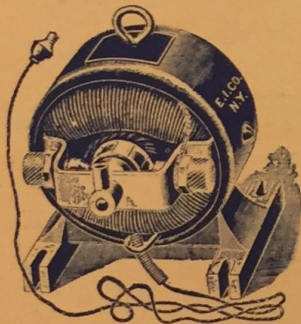

**POWER MOTORS.** Run on 110 V. A. C. or D. C. 1/30 h. p. Weight 2 3/4 lbs. 4 in. diameter. Price..... **\$5.50**

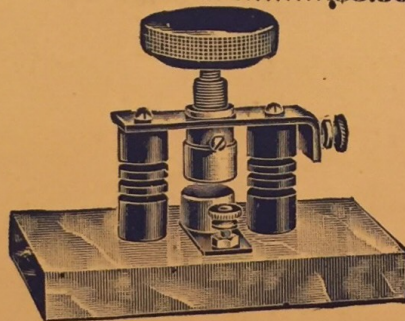

**COMMERCIAL SPARK GAP.** This is our best Spark Gap. Can be used up to 3 Kw. Has beautiful marble base, large zinc plugs. Price, **\$5.00**

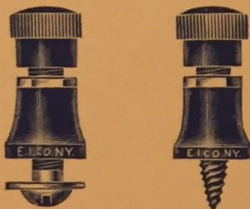

**HARD RUBBER BINDING POSTS.** No. 1919 or No. 1920. Price, each..... **5c**

Special Bronze Metal



Price, each..... **3c**  
Per dozen..... **30c**

**AERIAL LEAD-IN, 2-FT. LONG TELESCOPE STYLE,** fits any size wall. Absolutely weather and waterproof. "You bore the hole, we've done the rest." Price, each..... **75c**



**The Electro Importing Co.** 233 Fulton Street, New York City  
Retail Store, 69 West Broadway, N. Y.

"Everything for the Experimenter,"

Send 4 cents postage for 196 page Electric Cyclopedic Catalog No 9.

INSULATORS from 1,000 to 1,000,000 VOLTS



INSULATION

Standard of the World

Adopted by U. S. NAVY

and all Commercial Wireless Companies



Electrose Mfg. Co., 127-137 N. 10th St., 130-240 N. 11th St. Brooklyn, N. Y.

A TWO-FOOT  
MODEL AEROPLANE  
\$1.00

BLERHOT, CURTISS,

WRIGHT, SANTOS-DUMONT,  
ANTOINETTE, DEMOISELLE,  
OR FARMAN

Upon receipt of \$1 we will mail  
you postpaid a model of any of the  
above types of Aeroplanes.

All parts are furnished with simple  
instructions for every model.

Models Made to Order

a Specialty

National Aeroplane  
Mfg. Co.

385 EAST FOURTH STREET  
NEW YORK CITY

When writing, please mention "Modern Electrics."

# Patents Trade-Marks Copyrights

The value of a patent depends  
on the expert presentation of the  
claims that cover it. The value  
of your idea may be enormously  
increased by skillful handling of  
your application. My long ex-  
perience in the Patent Office,  
and in handling exclusively all  
classes of applications, gives my  
clients every possible advantage  
without extra cost. Valuable  
booklets on Patents, Trademarks,  
Designs and Copyrights sent on  
request.

LANGDON MOORE  
902a-F St., Washington, D. C.  
EX-ASST. EXAMINER U. S. PATENT OFFICE.

When writing, please mention "Modern Electrics."