

Succeed Through Electricity

This interesting story shows you the way to greater success in the Electrical Field.

This is the Electrical age. Electricity now controls more trades, directs more men, offers more opportunities than any other power that man has yet discovered. Through exact knowledge of Electricity you will advance in salary and position.

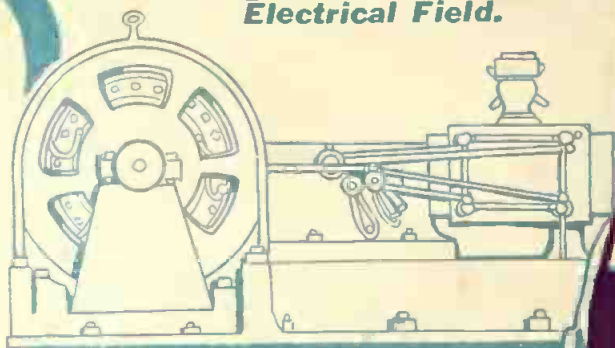

Hawkins Electrical Guides Will Show You How

These books are the standard works on Electrical Science. They are a complete and up-to-date course in Electrical Engineering, presenting the information in a way you can use it. Only \$1.00 per volume and owners of the set say there are no better electrical books published at any price.

Specially Arranged for Home Study and Reference They fit your pocket and your pocket book. Beautifully bound in flexible black leather with gold edges. Easy to read and handle. You can carry each single volume about with you until you have mastered the subject it contains. Written in the form of questions you would ask and the answers to them — in plain, practical, everyday language, complete, concise, authentic and to the point. Over 3200 pages and more than 4,000 illustrations.

Read These Testimonials

"Any Electrician, Operating Engineer, or Student who wants to do his own construction or further advance himself in the Electrical field should have a set of these books."

JOHN KELLEY
116 Union St., Newark, O.

"For the man not getting a college training and even in that case, I can sincerely say I do not believe there is a better set of books in the market today."

LLOYD D. HUFFMAN
Dayton, O.

"We consider Hawkins Electrical Guides the most compact and complete set of electrical references in the market."

NOGGLE ELECTRIC WORKS
Monterey, Cal.

"Hawkins surely knows the art of condensing information."

ELBRIDGE F. BALL
Buckland, Conn.

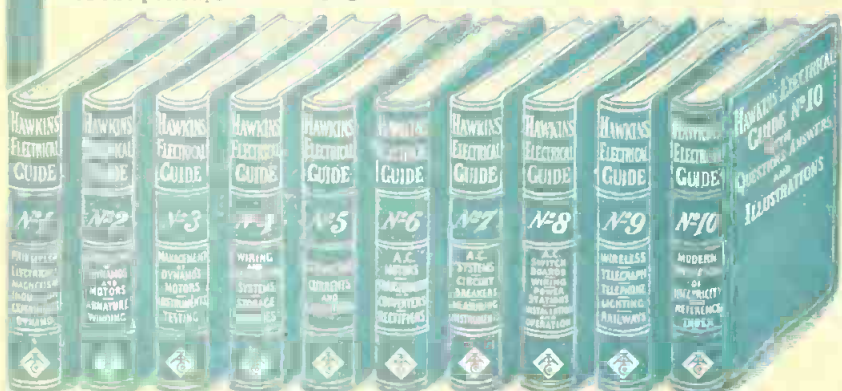

10 NUMBERS IN ALL

100
A Number
PAYABLE

100
A Month

Shipped to You FREE

YOUR
FREE
COUPON

Send no money. Examine the books first. Decide for yourself that they are the most complete library of Electricity ever published and that you cannot afford to be without them. Every book is complete in itself, but the complete set is the best bargain. The last volumes are just coming off the press. Eight numbers now ready.

EASY PAYMENTS

Accept this unusual low price — one day. Each page — every illustration — will convince you of

the big value we are offering. See the books first, then decide. If you decide to keep them you can make settlement at only \$1.00 monthly until paid for.

Theo. Audel & Co.

72 Fifth Avenue
NEW YORK

A FEW OF THE SUBJECTS
Magnetism — Induction — Experiments — Dynamos — Electrical Machinery — Motors — Armatures — Armature Winding — Installing of Dynamos — Electrical Measurements — Testing — Practical Management of Dynamos and Motors — Distribution Systems — Wiring Diagrams — Sign Flashers — Storage Batteries — Principles of Alternating Currents and Alternating Current Motors — Rectifiers — Alternating Current Systems — Circuit Breakers — Measuring Instruments — Wiring Boards — Wiring — Power Stations — Inlets — Telephone — Telegraph — Wire — Electric Light — Railways — Also many Modern Practical Applications of Electricity and Ready Reference Index of the 10 numbers.

Theo. Audel & Co.
72 Fifth Avenue, N.Y.

Please send me for FREE examination Hawkins Electrical Guides (Price \$1.00 each) Ship at once prepaid the first eight numbers. If satisfactory I agree to send you \$1.00 each month until paid.

Signature
Occupation
Business Address
Residence
Reference Mch E. E.



THE ELECTRICAL EXPERIMENTER

H. GERNSBACK EDITOR
H. W. SECOR ASSOCIATE EDITOR

Vol. III. Whole No. 36

APRIL, 1916

Number 12

How the Blind May Read by Sound

By Professor F. C. Brown

THE Phonopticon is an instrument that translates the varying light composites, particularly those of the printed page, into characteristic sound composites. The illumination from the printed page varies in intensity, form and sequence. The inventor of this valuable scientific device set out to translate this varying character of light, through electrical means, into sound impressions varying in pitch, intensity and sequence.

The only fundamental difficulty to be overcome was that of the production of some very light-sensitive agent which could be used in small size units. It was required that this agent should instantly change its electrical resistance whenever the light intensity varied. The ordinary selenium cells, where the amorphous selenium was crystallized in mass aggregates, were hardly satisfactory for three reasons. They were first of all insufficiently sensitive, were necessarily too large to properly discriminate printed letters and they lacked the stability and uniformity required. The inventor had the problem of the aural interpretation of the printed page through mechanical means casually in mind for three years before he succeeded in obtaining the specially sensitive crystals to do what the rods and cones do for the human eye.

Finally he succeeded in producing isolated crystals of selenium, such as are shown in Fig. 1, which were large enough to be placed in separate electrical currents and which were small enough to receive the impression from a fractional part of the smallest ordinary print. The crystals were grown by special means of sublimation of

the vapor of selenium, some of the most sensitive varieties requiring months for formation. In Fig. 1 A represents selenium

three-millionths as intense as the most sensitive thermopile. Experiment shows that with one of these crystals and a 21-inch telescope it is possible to detect the presence of a 16-cp. carbon lamp at a distance of more than 1,000 miles.

Thus these crystals in the phonopticon correspond in function and sensitiveness to the rods and cones of the human eye. The electric currents that pass through the crystals correspond to the nervous impulses that pass in the optic nerves. It might some day be possible, in certain cases of blindness, to connect these varying electric currents directly to the optic nerves and thereby get stimula similar to ordinary light stimula. However, the inventor chose a much easier road to the brain centers of the blind. He elected to transform these varying electric currents into corresponding varying sound characters and thereby let the blind

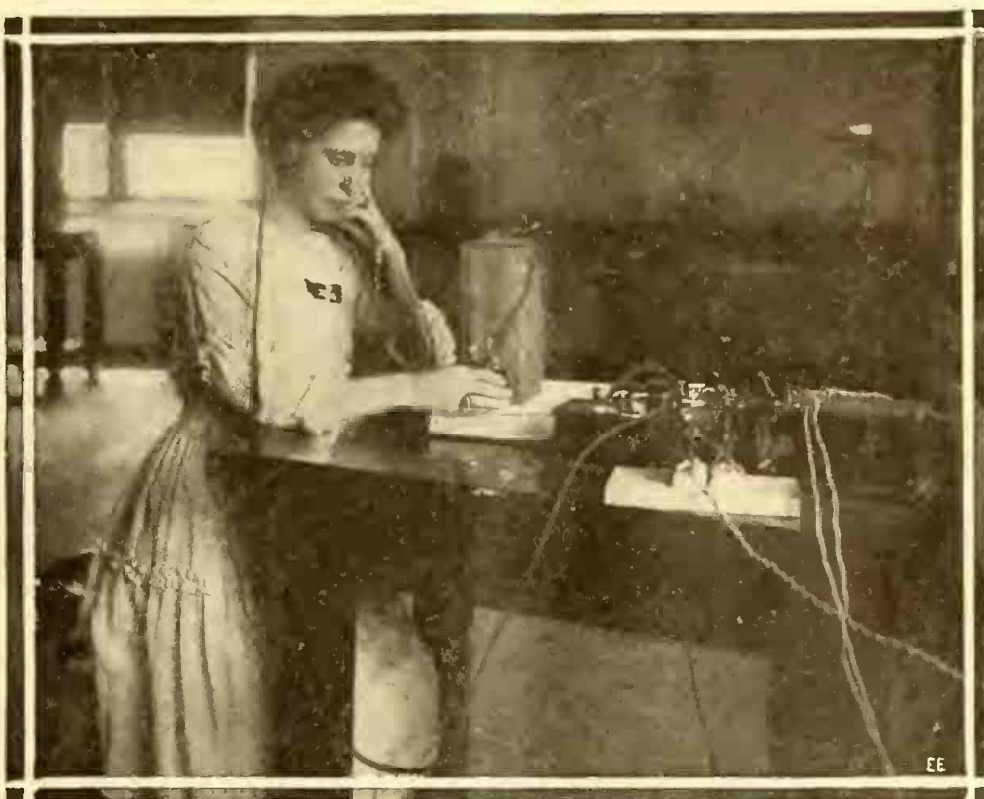

Marvelously Light-Sensitive Electrical Device Perfected by Prof. Brown by Which Blind People May Read by Sound.

crystals of the monoclinic system, B hexagonal crystals and C some interesting growths of crystals of selenium. These

see by hearing. The arrangement of the electric circuits and the selenium crystals is shown in a conventional way in Fig. 2.

DID you ever stop to realize how many thousands of the soldiers now battling for their lives in Europe's tragic catastrophe will return home blinded for the rest of their lives? Besides there are many thousand blind in our own country. To all these unfortunates there seems to be a new hope held forth, for by properly combining selenium and electricity Professor Brown has seemingly solved the problem of how the blind shall see, even though their eyes be closed. Would this invention not be well adapted to curtail eye-strain for those who have perfect vision?

crystals further were found to be stable and extremely sensitive to light. They are more than a hundred times more sensitive than the most sensitive standard selenium cell. One of the crystals will, with a sensitive galvanometer, respond to a light only

with each.

The printed letters are illuminated successively by a narrow ray of intense light which travels across the page. The image from the lens acts upon a parallel group of crystals, which control different frequencies

in the telephone receivers. The interrupters (18, 18, 18), in series with each crystal, give a different distinct pitch for each crystal affected.

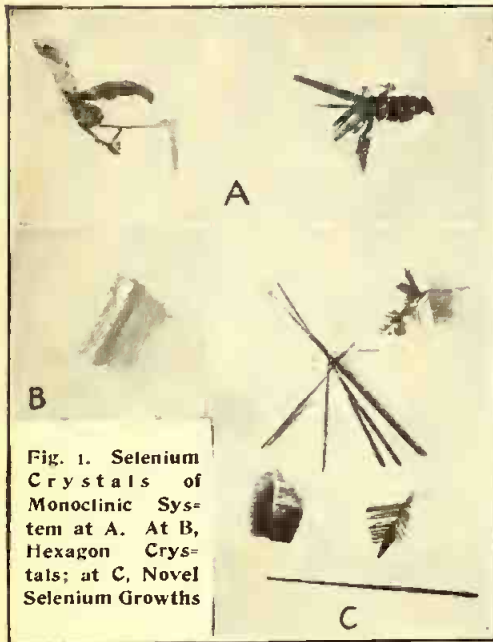

Electro Ray Projector, a Movie Concoction

Pearl White, "Pathé's Peerless Pearl," as she is called, still works her magic on the motion picture fans, and is undoubtedly the most popular little lady that has come to gladden the screen since—well, since she was last seen as the ebullient Elaine in company with Edwin Arden as the wicked Wu Fang, and Arnold Daly as the clever Craig Kennedy. She is still beautiful, blonde and beatific, and just the sort of person romantic things couldn't help happening to.

After being rescued by that mysterious avenger of wrongs, known to the underworld as "The Laughing Mask," and returned to the father she was kidnapped from when a child, she is again threatened by the sinister master criminal Legar, alias "The Iron Claw." Legar's purpose is to wreak vengeance on Enoch Golden, the girl's father, who, years before, finding Legar, then his friend, unfaithful, had the latter's face seared with white hot irons and his hand crushed in a vise.

To intimidate Golden into returning his daughter to his (Legar's) clutches, the master criminal with the help of Stein's

"Electro Ray Projector," a deadly instrument, sets fire to many of Golden's properties and threatens further mischief should his demands not be acceded to. Marjorie, the daughter, seeing that she is the cause of great misfortune to her father, voluntarily returns to "The Iron Claw."

But, by the looks of the thing, Legar won't have such easy sailing, for Davy Manly, Golden's secretary, has her interests at heart, and that other mysterious agent, "The Laughing Mask," promises to give further account of himself in the next chapter called "The Cognac Cask."

ELECTRIC 'BUSES IN ARABIA.

It is proposed to replace the horse-drawn carriages at Aden, Arabia, with buses using electric batteries. A bus that will carry six or seven passengers at a regular fare of about 12 cents from Steamer Point to Crater, about 5 miles, is expected to wrest all the business from the old-time pony carriages. The electric type is favored because of the high price of 36 cents a gallon for gasoline.

These electrical impulses, thus controlled, are converted into sound waves of a specific pitch or note by a resonator provided in each telephonic receiver. Three receivers are here used, their number corresponding to the number of crystals employed, which may vary from one to four. So that three receivers may be used at one time, there is incorporated in one receiver shell two resonator and diaphragm mechanisms, as seen in Fig. 3. Thus each "part" of a printed letter affects a certain crystal, and through it upon a separate interrupter and resonator (receiver). As the successive parts of a letter enter the lighted field before the lens (and crystals), the changes resultant are simultaneously manifested by a change in the pitch of the note.

When the little box containing the lens and the crystals is moved over the page a series of notes are heard in varying sequence, loudness and rapidity. The blind person soon learns the combination of notes and intensities produced by each letter and, in fact, by each word. One blind person was able after 20 minutes' practise to illus-

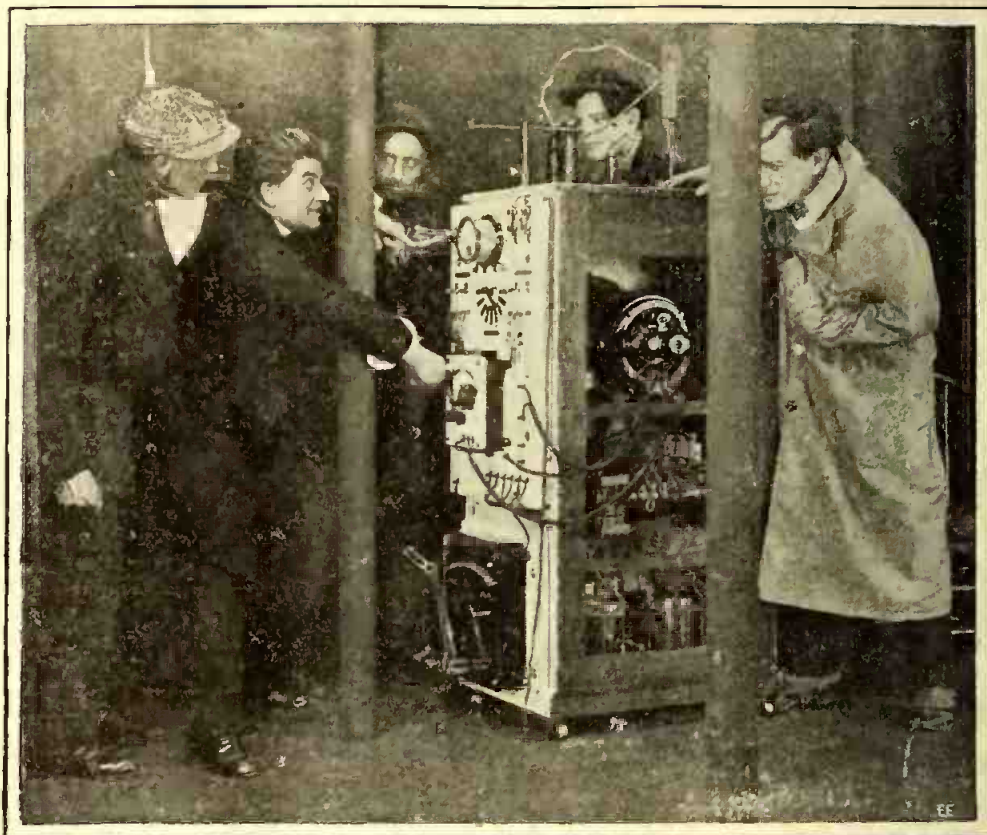

A "Thriller" from the Movies, When the Villain Demonstrates His Electro Ray Projector.

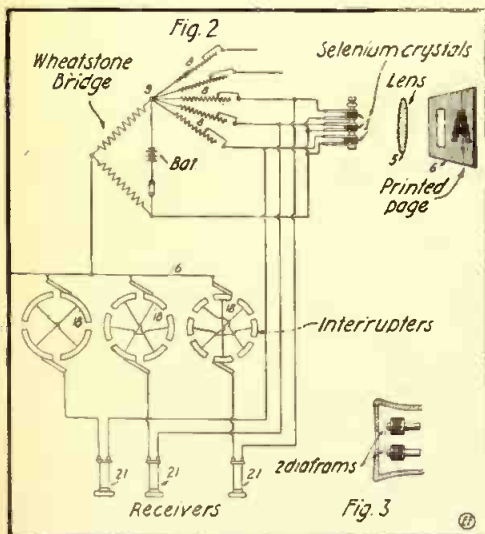

Diagram of Apparatus Enabling Blind to Read Electrically.

trate on the pipe organ the alphabet of the phonopticon.

CONGRESS INTERESTED IN RADIO TORPEDO.

Wireless control from an aeroplane of a coast-defense torpedo has been perfected, it was learned recently, and patents are included in the Hammond radio-controlled torpedo rights, for the purchase of which the Navy Department has asked Congress to appropriate nearly a million dollars.

Aeroplane control, navy officers explain, makes it possible for the operator to guide the radio torpedo through the water from any height, air bubbles from the compressed air motor of the torpedo giving him a certain guide by which to steer it against a ship's hull. By use of powerful glasses it has been possible heretofore to control the torpedo from shore to a distance of nearly 10,000 yards, but the aeroplane device now will make the missile effective to the full range of its motor capacity, or even far at sea if the torpedo is launched from a swift motor boat within sight of an enemy ship.

WHAT 1 CENT OF ELECTRICITY WILL DO.

- Operate sewing machine two hours.
 - Keep six-pound iron hot 15 minutes.
 - Heat electric curling iron 14 times.
 - Percolate four cups of coffee.
 - Lift 100 gallons of water 100 feet.
 - Give light of 75 candles for one hour.
 - Toast bread for six persons.
 - Operate luminous radiator for eight minutes.
 - Warm baby's bottle twice.
 - Cook Welsh rarebit in chafing dish.
 - Keep heating pad hot two hours.
 - Heat 8-inch electric stove eight minutes.
 - Operate 12-inch fan two hours.
 - Vulcanize four automobile tire patches.
 - Keep foot warmer hot one-quarter hour.
 - Raise passenger elevator five stories in a minute.
 - Operate electric griddle eight minutes.
- (Calculating current at 10 cents per kilowatt-hour rate.)

Searchlights and Radio Aid European Warriors

GERMAN SEARCHLIGHT THROWS BEAM EIGHT MILES.

The German military authorities, with proverbial thoroughness, have appropriated every branch of science available for the

difficult to make effective use of this arm of the military service at night.

In the illustration herewith a German officer is making observations by means of one of their extremely efficient searchlights

poles, wires, tent, blankets and other paraphernalia for camping, thereby making each group of the service independent of tall trees and houses on which the field wireless formerly relied for temporary headquarters.

The wireless camp resembles somewhat a battery of field artillery in its plan, having essentially one motorcycle unit which hauls the wireless sending and receiving equipment either in a side carriage or trailer, corresponding to the field piece, and another motorcycle hauling the service van, corresponding to the ammunition caisson. Having two machines in each set, the service consequently embraces 10 motorcycles and vans. The wireless operator rides behind the driver of the motorcycle on a spring tandem seat.

Power for the wireless station is furnished by a $5\frac{1}{2}$ horse-power twin cylinder engine, set up in one compartment of the van, which drives by direct chain drive a small two-in-one receiving and sending electric generator. The varying speeds at which the engine or generator may revolve are transmitted through a direct-drive chain, running on a compensating sprocket at the shaft of the generator, which insures smooth running. On its sending side the generator develops 700 volts, 2.6 amperes, being capable of sending a message nearly 500 miles by wireless, and on the receiving side 110 volts, 2.7 amperes for the audions. The operator's instruments are in the forward compartment of the van and when a halt is made, to set up communications, he removes the keyboard some distance from the power plant in order to hear better. He regulates the power of the engine by magnetic control of the throttle. Starting of the engine is accomplished by turning over a hand lever.

A supply of gasoline sufficient for 12 to 24 hours' continuous operation of the plant may be carried in the regular tank and three reserve tanks. The capacity of the



Photo Copyright by Underwood & Underwood

A Powerful German Army Searchlight in Action at Night in the Famous Flanders Region.

most expeditious conduct of scientific warfare, both on land and sea. This is exemplified in a marked manner by their very extensive employment of powerful electric searchlights, which are kept continually flashing through the night atmosphere in search of the enemy.

The searchlights are often used in groups of considerable numbers when a night attack is to be made by infantry or trenches are to be stormed. In other cases they prove extremely valuable to the artillery range finders, as otherwise it is often very

recently developed for use in the famous Flanders region, which extends for miles. It is possible for these searchlights to throw a strong beam *eight miles* away, even on cloudy nights.

A WIRELESS MOTORCYCLE FIELD STATION.

A number of "Indian" motorcycle wire-

ELECTRICALLY HEATED UNIFORMS NOW.

Austrian soldiers will not suffer from cold weather if the electrically heated garments which have just been invented by the professor of electricity at Innsbruck University prove feasible. The essential feature of the professor's invention, according to the Austrian newspapers, is a method of weaving electric heating threads into soldiers' pants and coats and then connecting the threads with a battery or supply wire at a distance of from 100 yards to a quarter of a mile. It is asserted that the current can be regulated so that any number of soldiers in the trenches can be kept warm simultaneously.

EDISON OPENS ELECTRIC SCHOOL.

An experimental school of electricity for the officers and men of the United States navy has been opened at Orange, N. J., by Thomas A. Edison, chairman of the Naval Advisory Board, acting in co-operation with Secretary Daniels. The men of the submarine flotilla who have to do with complicated electrical equipment will receive their training first.

Fourteen officers and 30 men from Quincy, Mass., and the New York navy yard recently finished a course.

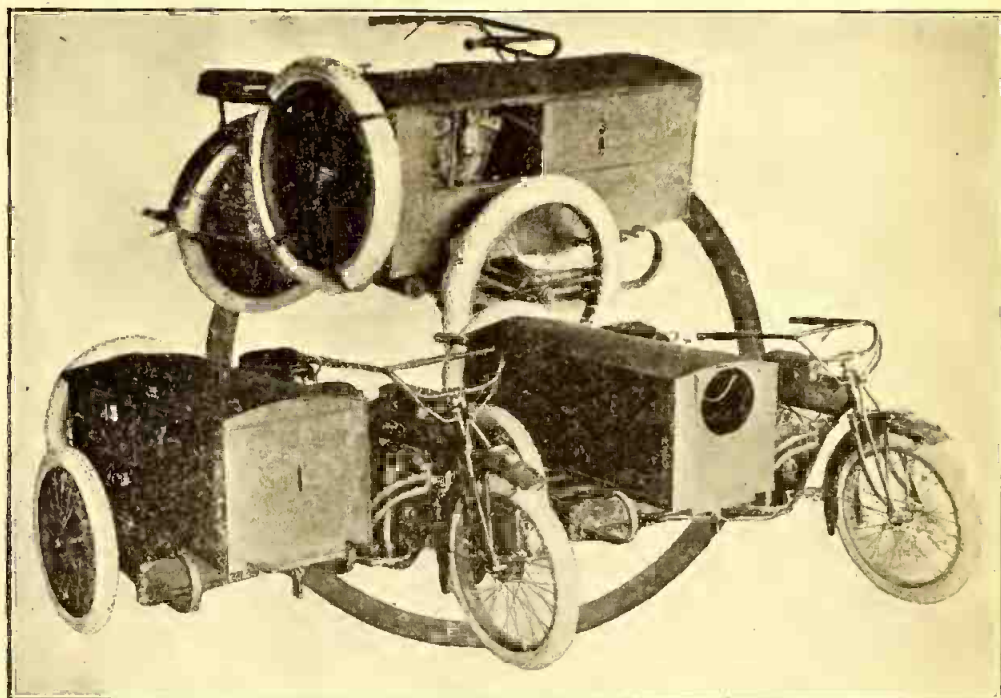

Type of Motor-Cycle Radio Pack Sets Now Being Built for Rapid Transit Over Battlefields.

less stations, which may be moved at will from point to point, have just been completed at Springfield, Mass. Besides the original instrument van and the machine to haul it, an additional feature is another motorcycle and van which serves to carry

gasoline tank on the motorcycle is sufficient for 100 miles of travel.

The weight of motorcycle and wireless van is about 1,176 pounds. The box is $4\frac{1}{2}$ feet long, $21\frac{1}{2}$ inches wide and 20 inches deep.

Historic Telephones

WHEN we step into the nearest telephone booth to-day and without the slightest trouble or delay are swiftly connected with our desired party, perhaps hundreds or even thousands of miles away, we do not always, or, in fact, rarely, stop to think of the vast amount of

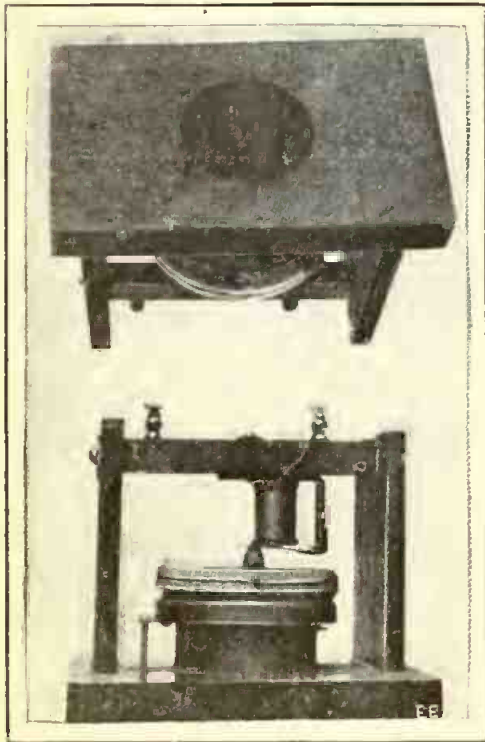

Fig. 2. Two Views of the First Bell Telephone Model, Utilizing a Diaphragm of Gold-Beater's Skin.

labor and gray matter expended on the telephone in the past 40 years, during which time it has slowly but surely developed into one of the greatest industries in the world's history.

We present herewith a number of interesting illustrations depicting the early models of the speaking telephone as perfected by Alexander Graham Bell and his assistant, Thomas A. Watson. In the year 1874 Prof. Bell was intensely interested in developing a harmonic telegraph instrument. The appearance of one of these devices is perceived at Fig. 1. These consisted of an electro-magnet supported on a yoke, and on the upper end of this yoke there was clamped a steel rod or spring of a certain musical pitch. It was Bell's idea that if, say, six of these instruments were hooked up to a common two-wire circuit, then it would be possible to transmit six distinct telegraphic messages over this line simultaneously, if each of the transmitter springs were of a different musical pitch. Each spring at the transmitter end of the line carried suitable contacts, so as to make and break the line circuit current, and, moreover, each transmitter spring

would vibrate at a certain frequency, owing to its being tuned in the manner described.

The discovery of the speaking telephone is directly allied with this seemingly unimportant piece of apparatus. This wonderful event occurred during a test of the musical telegraph apparatus conducted by Messrs. Bell and Watson on the afternoon of June 7, 1875, at Boston.

It was Watson's task to consecutively and repeatedly set the transmitter springs going on these musical telegraph instruments, while Bell at the other end of the line was busy retuning the receiver springs, one by one. This he usually accomplished by listening to each spring as he held it near his ear.

"One of the transmitter springs I was attending to stopped vibrating," relates Mr. Watson, "and I plucked it to start it again. However, it did not start according to schedule and I kept on plucking away on it, when suddenly I heard a shout from Bell in the next room. And out he came with a rush, demanding: 'What did you do? Don't change anything; let me see!' I showed Bell just what I had done, and the fact of the matter was that the make and break contact point of the transmitter spring I had been trying to start had become welded together, so that when I had snapped the spring the circuit had remained unbroken, while that strip of the magnetized steel, by its vibration over the pole of its magnet, was generating a current of electricity that varied in intensity precisely as the air varies in density within hearing distance of that spring. The undulating current so produced had passed through the line wire to the distant receiver, which, fortunately, was a mechanism that could transform that current back into an extremely faint echo of the vibrating spring which had generated it."

Bell took full cognizance of this startlingly scientific fact so suddenly demonstrated before him and directly he had built the first telephonic instrument ever

At the inner end of the mouthpiece chamber was tightly fastened a diaphragm of gold-beater's skin. The center of this diaphragm was joined to the free end of the spring on one of the harmonic instruments. The idea here was to force the steel spring to follow the vocal vibrations developed by the air currents impinging against the diaphragm primarily and thus to generate a current of electricity that would vary in intensity as the air varies in density during

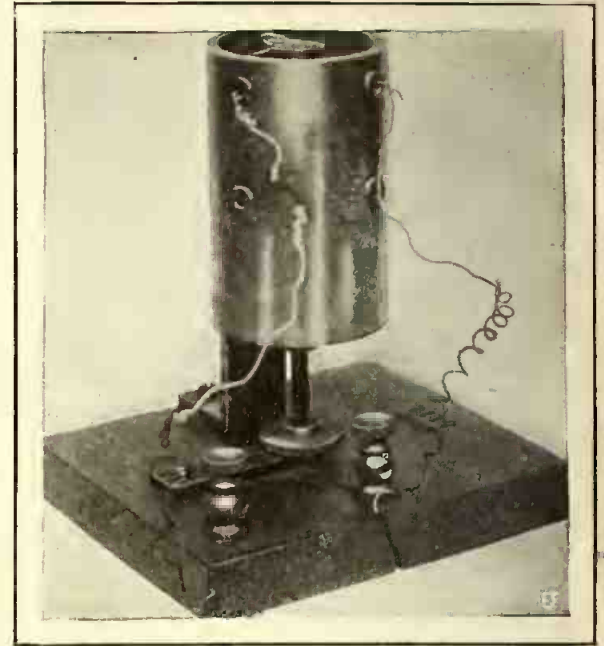

Fig. 4. Original Model Telephone Receiver Exhibited at Centennial Exposition.

the utterance of speech sounds. The first sentence ever spoken over this crude but marvelously correct telephonic device was that spoken by Prof. Bell: "Mr. Watson, please come here; I want you."

Hundreds of different ideas were tried out in the early days of the telephone, such as various sizes and kinds of diaphragms, magnets, mouthpieces, ad infinitum.

At the Centennial Exposition held at Philadelphia in 1876, and although the telephones of Prof. Bell were hardly ready for a practical demonstration on such an auspicious occasion, he finally was persuaded to exhibit a set of apparatus. The instruments were finished up in the best manner possible and worked very well indeed, considering that but a small amount of research work had been carried out to develop them at this time. The original Bell magneto transmitter exhibited at this Exposition was of the type illustrated at Fig. 3. The receiver or reproducer

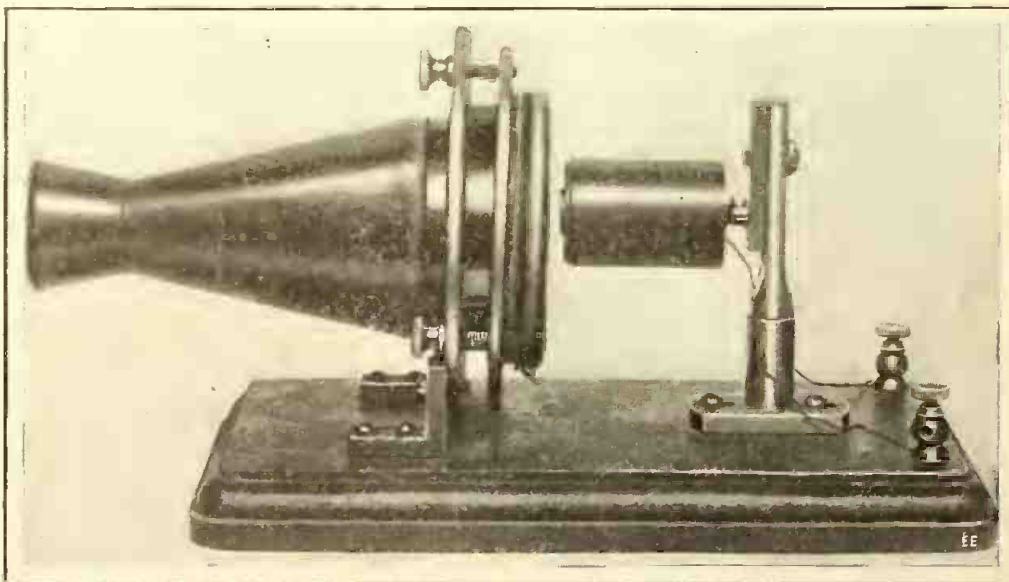

Fig. 3. The First Magneto Telephone Model (for Transmitting) Exhibited at the Centennial Exposition, Philadelphia, in 1876.

devised. This had the appearance illustrated at Fig. 2. The framework was made of wood, while the mouthpiece was formed in the frame itself, as perceived.

of the spoken word appears at Fig. 4. The transmitter demonstrated on this occasion employed a non-metallic diaphragm stretched over the inner opening of the

mouthpiece chamber, and to its center was secured a small piece of iron in the form of a disk. When the voice was projected

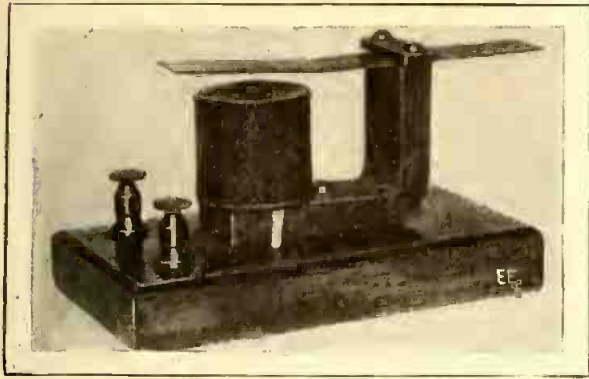

Fig. 1. Forerunner of the First Telephone; the Harmonic Reed Telegraph Devised by Prof. Bell.

into the mouthpiece the undulating air currents caused the diaphragm to vibrate in the same manner as it does in the instruments used to-day and corresponding electric currents were set up in the magnet coil mounted directly back of the diaphragm. These currents passed out over the line wire to the receiver of similar pattern, shown at Fig. 4.

Many distinguished visitors to the exposition heard the telephone talk and were astounded beyond words. The Emperor of Brazil happened to see the telephone on exhibition and asked for a demonstration. He listened intently at the receiving end of the circuit and was utterly astonished when the insignificant-looking device sitting on the table before him gave forth actual speech. He could only exclaim: "My God! it talks."

Sir William Thompson also tried the telephone, which, it must be remembered, was very new, even to the scientists of the day. This gentleman in his report on the telephone after his return home said: "I need hardly say that I was astonished and delighted, and so were others who visited the exhibition and verified it with their own ears, the electric transmission of speech."

The telephone began to develop shortly after this at a fairly decent rate and in April, 1877, the first outdoor telephone line was run between Mr. Williams' office at 109 Court street, Boston, and his house in Somerville. Fig. 5 depicts what was called the box type telephone. This was used in the Boston-to-New York test, which, after quite a good deal of experimenting and changing of line wires, etc., culminated in complete success.

In the first telephones perfected for single circuits no method was available for calling the party at the other end of the line when one wished to carry on conversation with him. Therefore when the telephone began to spread out and longer lines were in vogue, and especially when the first exchanges or central offices were started, some form of calling device became absolutely necessary.

It was common in the earliest instru-

ments installed for the party doing the calling to thump against the diaphragm of the apparatus with his pencil. Sometimes the pencil was not handy, so the next step was to use a sort of thumper. This is shown at Fig. 6. At the left of the apparatus, as observed, a small "calling" push button projected from the front of the cabinet. When this was pressed it actuated the small hammer, and in this way the thumps against the diaphragm were transformed into an undulating electric current which passed out over the line, giving rise to corresponding diaphragm "thumping" notes at the receiving instrument. Thus did the early 'phone subscriber notify the party wanted at the opposite end of the circuit that they were wanted at the instrument. To-day your 20th century 'phone user wants "instantaneous service" and no half-way business about it. Did you ever stop to contemplate what havoc would ensue in the present

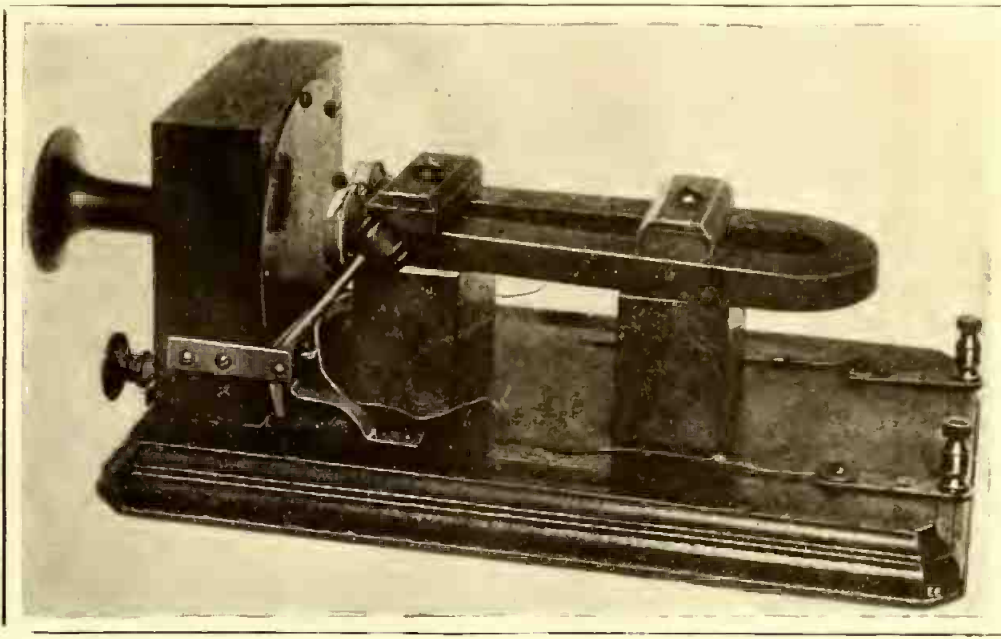

Fig. 6. One of the First Practical Telephones Developed. It is Equipped with a Calling Hammer, as Observed, Which "Thumped" the Diaphragm and These Signals, Reproduced at the Receiving Instrument, Notified the Party Wanted, but Not in the Most Gentle Manner, to be Sure.

business world with its thousands of diversified ramifications, if all the telephone lines were suddenly severed?

"The 'Watson thumper' brought me only a fleeting fame," says its inventor, "for I soon superseded it by a magneto-electric call bell that solved the problem, and was destined to make a long-suffering public turn cranks for the next 15 years or so, as it never had before, or ever will hereafter."

"Perhaps I didn't have any trouble with the plaguey thing! The generator part of it was only an adaptation of a mag-

neto shocking machine I found in Davis' Manual of Magnetism and worked well enough, but I was guilty of the jingling part of it. At any rate, I felt guilty when letters began to come from our agents reciting their woes with the thing, which they said had a trick of sticking and failing on the most important occasions to tinkle in response to the frantic crankings of the man who wanted you. But I soon got it so it behaved itself and it has been good ever since, for Chief Engineer Carty told me the other day that nothing better has ever been invented, that they have been manufactured by the millions all over the world, and that identical jingler to-day does practically all the world's telephone calling.

"For some reason, my usual good luck I presume, the magneto call bells didn't get my name attached to them. I never regretted this, for the agents, who bought them from Williams, impressed by the long and narrow box in which the mechanism was placed, promptly christened them 'Williams' Coffins.' I always thought that a narrow escape for me! The first few hun-

dreds of these call bells were a continuous shock to me for other reasons than their failure to respond. I used on them a switch, that had to be thrown one way by hand, when the telephone was being used, and then thrown back by hand to put the bell in circuit again. But the average man or woman wouldn't do this more than half the time, and I was obliged to try a series of devices, which culminated in that remarkable achievement of the human brain—the automatic switch—that only demanded of the public that it should hang up the telephone after it got through talking. This the public learned to do quite well after a few years of practise."

So the marvelous telephone, once called a device of the devil, has happily prospered to make man's work easier than ever before.

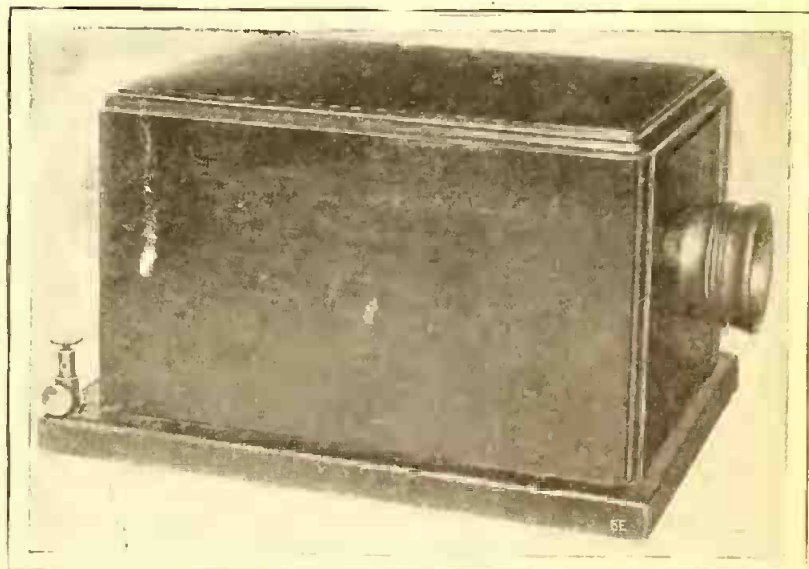

Fig. 3. Early "Box" Type Telephone Used in the Boston-to-New York Tests. A Wonderful Achievement in Its Day.

Lightning, Its Effects and How to Avoid Them

With the Approach of Summer it Behooves Us to Learn All We Can on the Subject of Lightning and Protection from Same. The Safest Place for Individuals During Thunder Storms Is Covered Herein.

By H. Winfield Secor

NO electrical discharge ever produced by mortal man can approach the awe-inspiring and wonderfully spectacular electrical displays taking place in nature and which we know as lightning. Lightning is an electrical discharge caused by the air breaking down where two opposite electric charges exist on two adjacent clouds or between the earth and a cloud.

"The prime cause of lightning is the sunbeam," says Prof. West Dodd. The cloud does not gather electricity out of the air as many people imagine. The electrical energy in the cloud is due to sun heat which brings about the rapid evaporation of water.

Heat is one of the nine forms of energy, and when evaporation of water takes place, the sun heat that caused the evaporation changes into one of the other forms of energy. The little globules float away, each carrying its own little quantity of "energy" or "strain" on its surface, and when the countless billions of these energized, invisible globules rise to the sky, where the cold of elevation rapidly condenses them into raindrops, this energy is released in the form of electricity, ready to give back the energy of the sun condensed into lightning flashes.

Our philosophers try to teach us this: "Before the house is struck by lightning an electric strain is placed upon it." That is, a condition has been coaxed into it, and it is this condition we have to deal with if we would prevent it from bursting into a lightning explosion.

But if a fog extended from the cloud to the earth, this condition would not exist, as the electricity easily reaches the earth through the fog by conduction and thus no lightning is produced.

Also you possibly remember that you never saw lightning on a foggy day, but when the air is dry the earth directly beneath the charged cloud is electrified in

a cloud. Then this cloud fixes up things on the earth and induces an opposite electric condition, and the two electrified surfaces strain and pull on each other; then when the strain becomes great enough so that the air cannot resist any longer, off it goes with an explosion through the house, and probably the undertaker has a job on his hands.

Having shown as clearly as possible in so short a time the cause of lightning and how the flash is brought about, let us consider briefly the remedy or how the stroke may be averted.

Let us begin by calling to mind that there are some things lightning will not strike. There is a reason for it. "Chance" is unknown in the operation of nature's forces. There is no safer place on earth from lightning than in a steam engine or in a railroad coach. No one was ever known to be injured by lightning when in a railway train. Lightning will not strike the business part of a big city. The tall skyscrapers of our large cities are immune from lightning, and insurance companies never have any losses from lightning on any building with metallic sides and frame work of iron and steel. It will not strike a modern battleship, on account of the material of which it is constructed, and a steel windmill tower is never injured by lightning. The reason is that every one of these objects is its own lightning rod. They need no further protection.

But there are things lightning will strike. Lightning will strike a country home, or a home in the suburban part of the city. Lightning will strike a barn or a church or a schoolhouse or a tree or a stack or an animal, especially if near a wire fence. All of the lightning losses our insurance companies have to pay are on this class of risks, and a man has to be blind almost purposely, not to see room for thought in these observations.

bed frame. If you are sleeping on steel springs in a wooden bed, the springs would save you if you are in the center of the bed, while the bed posts would be split to pieces and possibly the bed would be set on fire. During the day the safest place is in the center of the room if away from the stove. Open doors and windows make no difference, as lightning does not come in at open doors, as many people imagine, says Prof. Dodd.

Referring to the illustrations herewith a particularly heavy lightning discharge is observed at Fig. 1. A series of multiple flashes emanating from a cloud of high electrical activity is perceived at Fig. 2. The illustration at Fig. 3 shows a lightning bolt striking in a field near a building. This is a particularly bad form of discharge and its path is quite direct, as may be observed. Fig. 4 illustrates a rather common form of lightning discharge which is very beautiful to be sure. In this case the lightning tends to discharge between one cloud and several other clouds, providing in this way a most spectacular effect, lighting up the whole sky. Very little thunder accompanies such discharges as this one for the lightning takes place so far above the earth that the thunder (sound caused by the lightning flash), or at least the greater portion, does not reach our ears. The illustration at Fig. 5 shows the lightning flashes often observed in the country or suburban districts. The display in this case is particularly severe, as there are two distinct flashes occurring simultaneously. The heavier discharge seen in the distance has no doubt proved very disastrous, judging from its appearance, to any building or structure of similar nature which might have been in its path.

In many instances the lightning simply strikes the earth without harming any one or any structure such as a house or barn. All electrical transmission, telegraph and



Fig. 1. A Particularly Heavy Lightning Flash.

sympathy with the cloud and tries to discharge to the cloud the same as the cloud tries to discharge to it, and a great electrical strain is set up between the cloud and the earth.

The air is a poor conductor of electricity; and things that stick up from the earth into the air, like houses and barns, become discharging points for the earth's electricity, and in this way the house really prepares to be struck.

So the lesson we wish to impress here is this: Lightning is due to causes. Electricity first gets in its work and loads up



Fig. 2. A Series of Multiple Lightning Flashes Emanating from a Cloud of High Electrical Activity.

Where is the safest place in the house during a thunderstorm? Your metallic bed. This may surprise you, but at night the safest place is sleeping in an iron or brass bed. To stand by the metal bed is very dangerous, for you are taller than the bed, but lying on it is safe, as the bed extends above and below you, and the current will not have the bed to pass through you, also the current will not leave it, but the walls above the bed and the floor beneath would be ripped to pieces. Contrary to popular opinion, feather beds are not safe to sleep on, unless they are in a metal



Fig. 3. Lightning Bolt Striking in a Field.

telephone systems suffer to a greater or less extent from lightning during the summer months. Suitable protective measures have to be taken accordingly. Lightning protective apparatus such as minute spark gaps and the like are installed on such circuits, with proper ground connection attached to the gaps, etc., so that any heavy current produced on these lines by lightning discharges will pass to the earth without entering the switchboards, thus burning out delicate and expensive apparatus, besides often proving fatal to human life.

With regard to the potentials of light-

ning flashes but little more than estimates are available. The potential required to cause a flash of lightning a mile long has been estimated by Lodge to be 5,000,000,000 volts; using as a basis the breakdown voltage of air, which is about 30,000 volts per cm. Although this seems rather improbable it can be shown by calculation, based on experimental evidence at hand as to the electric charges of falling rain, that such voltage conditions may be realized. Prof. Trowbridge, however, has cast doubt over the validity of these figures by means of experiments with voltages exceeding a million, which seem to indicate that with long air gaps and extremely high potentials, air may exhibit properties quite different from those shown under the voltage conditions which have hitherto been realized. In designing a system of lightning rods the only potentials which need to be considered are those set up in the system itself.

The well-known flickering of lightning flashes, which is visible to the unaided eye, indicates that a flash of lightning does not always consist of a single discharge of electricity, but, on the contrary, consists usually of a number of successive discharges which follow each other with very short time intervals between them. By standing where the light from a flash does not blind the eyes, an observer can detect the successive discharges for each complete flash of lightning, the number of which varies, for different flashes, from 2 or 3 to 10 or more.

The frequency of a stroke of lightning has been calculated by Emde, by assuming (1) a circular conducting cloud and a circular portion of the earth's surface situated symmetrically below it; between these the lines of force are normal to both; (2) a concentric cylinder occupied by incandescent gas between the cloud and the earth; (3) that the current density is the same in each cross-section of this cylinder, i.e., that no waves exist along the gas column. By making additional assumptions in regard to the diameter of the cloud and flash, Emde finds a frequency of from 2,000 to 8,000 cycles per second, or an average of 5,000 cycles. There is some doubt, however, as to the validity of Emde's assumptions, and his results should, perhaps, be taken only as in some degree confirmatory of the opinion which more or less generally is held that lightning is, in effect, an electrical discharge of medium frequency; that is, *hundreds of thousands of cycles per second*; as distinguished from low frequencies of a few hundreds of cycles per second, or high frequencies to a million or more cycles per second; and in most cases is of sufficiently steep wave front to excite secondary high-frequency phenomena, even though it may be so rapidly damped as to be practically a unidirectional discharge. To state definitely what ranges the frequency of lightning discharges may cover, however, requires that much more experimental work be done.

From data in several fire tables covering a period of 19 years prior to the year 1903 given in a publication issued by the Government on "Lightning and Protection from Same," there is shown that out of 146,618 fires from all causes in barns, stables and granaries, there were 14,968 caused from lightning. These figures include the total of all fires both known and

unknown. The percentage of fires caused by lightning having been 10.2 per cent. The per cent. of fires from known causes and which were due to lightning comes up to 21.5 per cent. At any rate and especially from statistics obtained by various insurance companies in the Central and Western States, where there are a great many isolated barns, dwellings and other buildings, owing to the large farming sections,

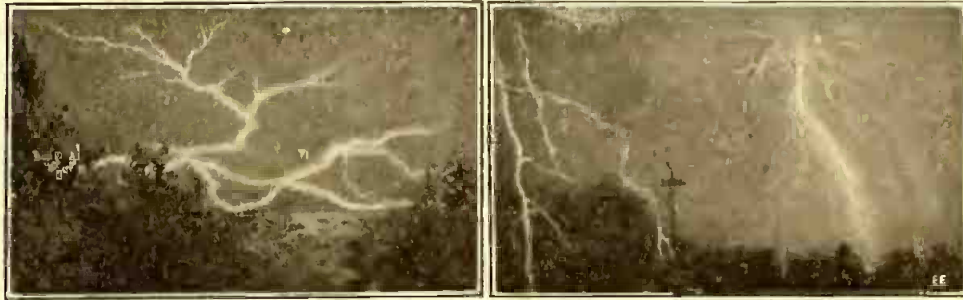

Fig. 4. (Left), Illustrates a Rather Common Form of Lightning Discharge Often Seen Over Bodies of Water. Fig. 5 (Right), Double Flash, Often Observed in Suburban Districts.

there is a great risk incurred during the summer months by lightning destroying or partially destroying such structures and also killing live stock. Animals are often killed by coming in contact with charged fence wires. In the Eastern part of the United States not much attention is paid to protection from lightning as in general there are a greater number of cities and also steel frame buildings are more in vogue. Such buildings and also where dwellings or other edifices are gathered into solid blocks and in addition provided with metal roofs connected to the ground through leader pipes, etc., the lightning has very little chance to create any disruptive discharge, but instead is dissipated noiselessly into the earth through the greater surface leakage thus provided for it.

In the case of isolated frame structures or other buildings, not provided with steel framework, there is only one safe method to follow for the protection against lightning, and this is to install proper lightning rod systems. Every isolated dwelling, barn and other outbuildings of any consequence should be protected in this way from the ravages of nature against the electrical demonstrations of which it is not safe to gamble or bet.

The safe way is the best way, and it seems as in many other lines of human endeavor the modern systems of *rodding a house*, as it is called, for lightning protection has eliminated the old-time glass insulator, which was ridiculously small and in fact, if anything, conducted to the disruptive or flash discharge of the lightning current.

Regarding lightning protection by means of metal wires or rods properly placed over a building, and particularly at all of the highest points of the roof of same, such as chimneys or gable peaks, this is well covered in what is known as "The Phoenix Fire Office Rules for Lightning Rods."

Sir Oliver Lodge, the famous English scientist, has made an exhaustive study, in so far as possible, of lightning and its effects on buildings toward the end of protecting them by metal wires properly erected over or installed on the building itself. It has been found that to guarantee the utmost protection in this direction, the building should be literally enclosed in a heavy cross-connected wire frame work resembling a bird cage. It is manifestly quite impossible to go to any such expense or to have a building so thoroughly covered as to become unsightly with any such arrangement as this.

In a modification of this system for an ordinary building, a sufficient practical ap-

proach to ideal conditions can be attained by taking advantage of the extent of metal work outside it and adding a few other conductors, so as to surround it and imitate roughly a metallic inclosure. Under expert supervision this can be accomplished by utilizing the rain-water pipes and gutters as part of the system. Joints in the pipes and gutters act more securely when "bonded" together or made electrically continuous. The ordinary conductors must be fixed in addition, and the whole system of pipes, etc., together with the special conductors, may advantageously be interconnected by a horizontal conductor taken round the buildings, either two or three feet above the ground level or buried in the ground.

The complete system should then be efficiently connected to earth at several places.

A building with trees adjacent to it, or dominated by a steeple or other lofty building, must not be considered as immune. A discharge is seldom solitary, along one single path; it is often an assemblage or bush of flashes, and all points in the neighborhood are liable to be struck by some of the subsidiary or accompanying discharges. Even underground cellars have been so invaded.

Material of conductor. Material should be of copper tape at least 1 inch by $\frac{1}{8}$ inch, or of a stranded copper rope of not less area; no cable to be smaller than that composed of seven strands, each of $\frac{1}{8}$ inch diameter, or of soft iron cable, properly galvanized or sheradized; the total sectional-area of iron cable need not be greater than that of copper, except for chemical reasons and permanence. In inaccessible places, and atmospheres where chemical corrosion may be feared, copper should be used of larger sectional-area than 1 by $\frac{1}{8}$ inch.

Conductors should be run in as direct a line to earth as convenient, and sharp bends and joints avoided; they should be kept a certain distance away from the walls. The object of keeping conductors a certain distance away from walls is to prevent accumulation of dirt, and to avoid sharp bends when passing over cornices, etc., but they must not be insulated from the walls.

For tape conductors all joints must be carefully soldered and made electrically and mechanically continuous, i.e., screwed together or clamped. Stranded cable conductors should be connected by lineman's joints and soldered or united by a special joint box. After the strands of the cable are twisted together, the box should be filled in with molten solder.

Elevation rods should be of solid copper or galvanized iron of ample cross-section and fixed at least two feet above that portion of the building to which they are attached by a sleeve joint soldered and pinned, or by means of a box-joint filled with solder and pinned. In the case of chimney stacks, the rod must extend at least one foot above the highest chimney in the group which forms the stack.

Hold-fasts should be of gun metal or brass for copper conductors or of malleable iron for iron conductors and let into the wall in such a manner as to support and keep the conductor away from the structure at such a distance as will avoid any-

(Continued on page 737.)

A "Hook-less" Telephone Receiver the Latest

By Samuel Cohen

ALL telephone instruments now in use require a "hook-switch" or its mechanical equivalent upon the proper manipulation of which, among other things, depends the efficiency of the telephone serv-

storing it to the *telephone hook*. This is pivoted or otherwise mounted in bearings in such a manner as to make alternate contact with upper and lower spring connections, designed to open and close the respective electrical circuits. If the receiver is accidentally left off the hook after the conversation is finished, the line is reported "busy" to all inquirers until the error is eventually discovered and rectified by Central.

In a recently devised automatic gravity switch telephone the hook-switch together with the other complicated features of the present apparatus are entirely done away with. The telephone receiver, which is shown in Fig. 1, has a spheroidal shape and is about the size of a pear. As perceived from Fig. 2, it contains within itself all the requisite switching mechanism. The sectional view clearly illustrates the inner parts of this very unique telephone receiver. A small quantity of mercury or an equally mobile conducting substance is enclosed within a hermetically sealed, conical shaped switching cup made of iron or steel, in which it is free to move under the influence of gravity. When the receiver, which requires no hook support and is, therefore, mechan-



Fig. 1. Remarkable Innovation in Telephone Receivers, Combining Automatic Gravity Switch in Its Design.

ically independent of the transmitter, is lifted from the normally vertical position (which it assumes when hanging by its cord or when resting on a table) to an approximately horizontal one, assumed when placed to the ear, the mercury immediately changes its position and moves from the lower to the upper portion of the conical cup. In so doing it automatically touches the central disc which is connected to the calling circuit, thus transmitting the calling signal and at the same time establishing electrical connections with the talking circuit. This circuit is made by the mercury and the upper right terminal in Fig. 2.

The natural act of putting down or releasing the receiver from the hand after conversation is finished causes the mercury to flow back to the lower end of the cup and in so doing (provided the receiver at the other end of the line has also been set down) automatically operates the "ringing off" or "clearing out" signal at Central, disconnects the talking circuit and restores the subscriber's line to its normal condition ready for another call.

In other words, the natural act of picking up the receiver when one wishes to talk and laying it aside when through causes the automatic and instantaneous action of all the operations which the operator and subscriber have to perform to-day. Thus, for the first time in the history of telephony, there is an elimination of the personal equation of the subscriber from the problem of exchange operation,

in which he is now such an important yet at the same time so unreliable a factor.

The regular telephone electromagnet, permanent magnet and diaphragm are located at the lower end of the shell, as perceived, in the cross-section illustration, Fig. 2. In desk telephone outfits the hook is dispensed with and the receiver is automatically kept in a vertical position by the heavy metal cap piece at the lower end of the receiver case. This causes it to resume its normal position when laid down ready for further service. In this instrument only the receiver has to be picked up, as the transmitter need not be handled.

Despite its simplicity, containing as it does but one moving part and that absolutely permanent and indestructible, it performs its manifold duties as above outlined correctly, without regard to the skill of the subscriber or users and with far greater precision and promptness than the most careful and experienced subscriber can command under the present antiquated hook-switch system. With this system a great deal of Central's time is saved by unnecessary questions which the operator begins to ask, such as "Are you waiting?" "Are you through?" etc., etc.

This unique automatic gravity switch telephone was perfected by Elias E. Ries, a well-known consulting electrical engineer of New York City, and his system, fully protected by patents here and abroad, will undoubtedly find favor with telephone companies at an early date it would seem.

A NOVEL MONOCOIL MOTOR.

There has recently been produced a

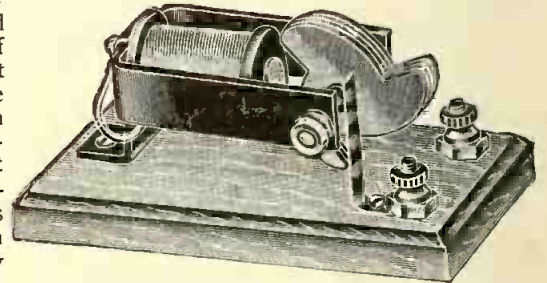

Simple Battery Motor Utilizing but One Electromagnet.

miniature battery motor which can be built for probably less money than any other motor ever designed, considering the power of it. This motor is shown in the accompanying illustration. But one electromagnet is used in its operation and one dry cell will operate this motor at high speed. The current through the electromagnet is made and broken as the armature rotates by means of a circuit-breaker mounted on the shaft, against which a spring brush bears. The principle is well known in dynamo-electric phenomena, but very few motors have ever been built of this type. The motor consumes only .4 of an ampere when operated on a single dry cell. The comparatively heavy armature acts as a flywheel, thus causing the machine to develop a surprising amount of power, considering its size.

HIS ONLY POSSIBILITY.

"I believe," said the impatient man, as he put aside the telephone, "that I'll go fishing."

"Didn't know you cared for fishing."

"I don't, ordinarily. But it's the only chance I have of finding myself at the end of a line that isn't busy."

TWENTY-FOUR HOUR CLOCKS.

The 24-hour system of reckoning time was adopted by the telegraph and telephone authorities in Denmark Jan. 1. The system is in use in Sweden, Russia and Norway.

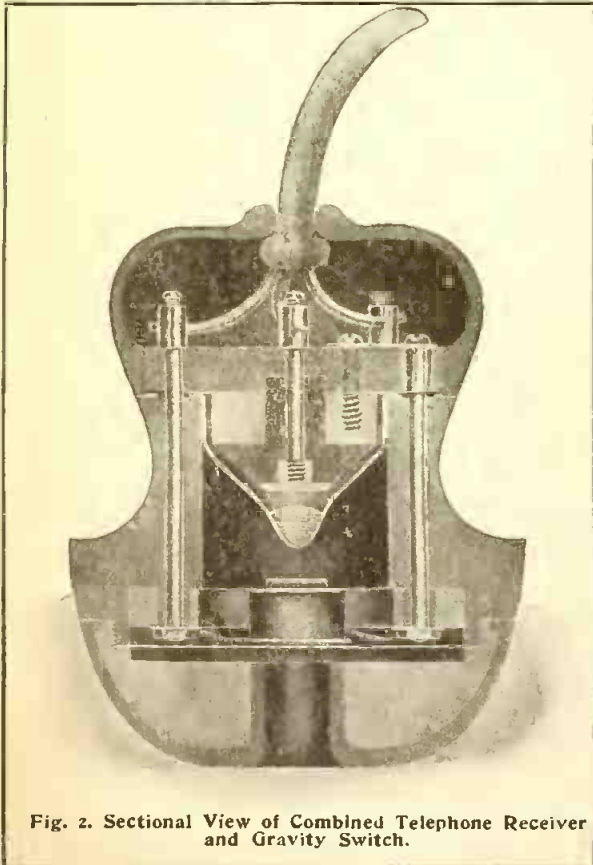

Fig. 2. Sectional View of Combined Telephone Receiver and Gravity Switch.

modern telephone exchange service, are now transmitted by the subscriber in the act of removing his receiver from and re-

tory of telephony, there is an elimination of the personal equation of the subscriber from the problem of exchange operation,

April the Birth-Month of Two Famous Electrical Pioneers

SAMUEL F. B. MORSE.

(Born April 27, 1791—Died April 2, 1872.)

April, 1916, marks his 124th birthday.

Samuel Finley Breese Morse was born on the 27th day of April, 1791, at Charleston, Mass.

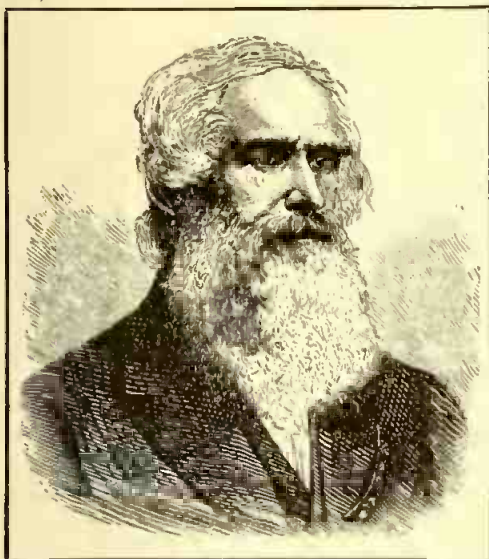

Samuel F. B. Morse, Who Developed the First Successful Telegraph.

He started first as an artist, and in order to get better technique studied in Europe twice, during the years 1811-15 and from 1829 to 1832.

During the return voyage from Europe, after his second visit in the year 1832, it happened that he made the acquaintance of Prof. Chas. T. Jackson, of Boston. On the ship he noticed the electrical experiments of the professor, during which the latter made the remark that it should be possible to use electricity as a means of signaling.

After his return from Europe, Morse again devoted all his time to his painting, but he did not seem to make a success of it and was always more or less in financial trouble.

He was the head of the National Academy of Painters, and in the year 1835 received the title of professor. In November of this same year he took up his telegraphic experiments, but inasmuch as he had had very little experience with electricity and as he was not much of a mechanic, he did not obtain any results whatsoever.

In the year 1836 a professor of chemistry, Leonard Gale, gave Morse a great many pointers on electricity, and it was through him that Morse was able to construct his first electro-magnet. As it happened Prof. Gale was afterwards associated with Morse.

Not until the year 1837 were his labors crowned with success and his first apparatus to transmit signals was perfected.

About this time Morse made the acquaintance of Alfred Vail, who supported him financially, and thus Vail also became one of Morse's associates. A good machine was now built and on the 4th of September, 1837, the experiment could finally be called a success, as the first real message was sent over the wires. However, the world did not accept this great invention immediately and at various times Morse endeavored to interest capital in his invention.

O. J. Smith, a member of Congress, gave Morse financial aid and made it possible for him to go to Europe in order to exploit his invention. This, however, proved a failure and he returned to New York

in 1839. Morse again resorted to painting in order to make a living. Finally in the year 1843 Congress appropriated \$30,000 to put up a large experimental line. This first line, 40 miles long, was erected between Washington and Baltimore and was tested out primarily in May, 1844. Morse's apparatus during this time had undergone a great many changes and very much resembled the present day telegraph instruments.

After this, in an astonishingly short time, Morse's telegraph found its way all over the world. Morse became electrician for the New York and Newfoundland Telegraph Company. In the year 1857 ten of the countries of Europe united in presenting him with a gift of \$100,000.

He died in a suburb of Poughkeepsie, N. Y., April 2, 1872, leaving a name long to be remembered among all people.

RAIMOND LOUISE

GASTON PLANTÉ.

(Born 1834—Died 1889.)

April, 1916, marks his 82d birthday.

The electric storage battery has come into such general use since the advent of



M. Raimond Louise Gaston Plante, Inventor of the Storage Battery.

the automobile, the electric truck and the submarine that it is well to remember that its development was due to Gaston Planté.

It should not be forgotten that the chemical storage battery does not actually store up electricity. When the battery is being charged the flow of current causes a certain chemical action to take place in the battery. When the battery is discharged this process is reversed and the chemical reaction sets up a flow of electricity.

Raimond Louise Gaston Planté was born at Orthez, France, April 22, 1834. He was educated at the Conservatoire des Arts et Metiers in Paris. His profession was that of a chemist, and his principal work was the investigation of the nature of electrical polarization, which finally led to his discovery of the lead accumulator, which bears his name and has given him his fame.

He was always an indefatigable experimenter, and as a result of his experiments on the discharge of cells, he developed a weakness of vision, which greatly handicapped him and which led, in 1862, to his retirement to private life. In 1860 he was appointed to the chair of Professor of Physics of the Polytechnic Association in Paris.

Planté's best-known work is "Recherches sur l'Electricité," issued in 1879, this covering his contributions to the Academy of Science. An immense number of experiments are described in this book, including those which were made with a lead battery of no fewer than 800 elements. It also included a brief description of his rheostatic machine, for which he received the Academy of Sciences prize in 1881. Planté received the diplome d'honneur at the Paris Exposition in 1881 and was also made a Chevalier of the Legion of Honor. It is said that the name of Planté ought to be handed down with those of Volta and Ampère as among the immortal founders of the science of electricity. Renowned for his modesty and amiability, he never troubled about securing patents during the development of his discoveries—although he was fully alive to their possibilities, preferring to let the world benefit by the additional experiments and discoveries of other scientists. He died at Paris, May 5, 1889.

NEW ELECTRIC AUTO SIGNAL SAFEGUARDS DRIVER AND PUBLIC.

By Lester L. Sargent.

A new electrically operated direction bar or arm for automobiles, invented by Ralph B. Baker, takes the place of a person's arm in indicating which way the car is to turn in rounding corners. The device is combined with the license plate. That is, the license plate is fastened over the box which contains the electric motor and gear wheels which engage two electric bars, one of which is arranged to mesh with a ratchet bar attached to each direction arm. There are two direction arms, one adapted to reach out at either side of the license plate. Arrows are painted on them and they also carry a signal light at the outer end to render them conspicuous at night. The device may be used independently of the license plate, but for reasons of economy and convenience the plate carrier is utilized to contain the electric mechanism that operates the signal arms. The tail light is mounted over the license plate, so as to illuminate both that plate and the direction arms or bars. The small electric motors required for the operation of the device can be operated from the ignition battery of the car.

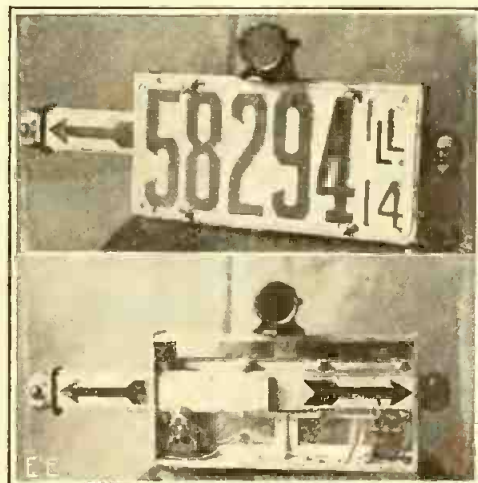

Open and Closed Views of New Motor Driven Auto Signal Intended for Rear of Car.

NEW ZEALAND TELEPHONES.

The telephone system of New Zealand is being rapidly developed by the National Government with up-to-date material and appliances, much of which is now coming from the United States.

A Writing Machine That Responds to the Voice

WHILE there are many highly ingenious electrical instruments available and, in commercial use to-day, including the almost human Telautograph, which will transmit and reproduce ordinary writing, sketches, etc., over an electrical

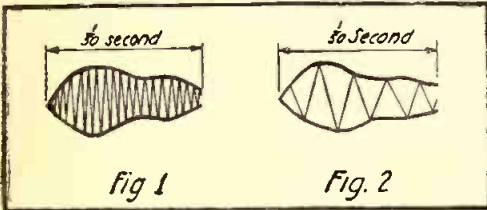

Demonstrating the Wave Form Characteristic of Letter "B," Uttered Normally at Fig. 1; at a Lower Pitch at Fig. 2.

circuit of considerable length, there is nothing that will more astound the layman than a contrivance so perfectly devised that it will typewrite a message corresponding to any speech delivered vocally to it. In other words, a writing machine that will respond to the voice directly has been the goal striven for by a Brooklyn, N. Y., electrical engineer, John D. Flowers.

Several years ago there were articles published in the technical press about a voice-operated typewriter devised by this inventor and the different letters of the English alphabet were controlled in that case by suitably arranging a number of differently tuned reeds. As the different reeds corresponded to the various characteristics of speech, it becomes evident how this arrangement might work out. This scheme operated fairly well when simple words were clearly spoken in the receiver of the instrument, but it was difficult for this hyper-scientific mechanism to distinguish the consonants.

Much time was spent in experimentation on the failure of the machine to respond to these consonant sounds, but without avail, and finally the inventor concluded that what was required was a much closer study of the minute, and, as we now know, the exact changes and fluctuations of the human voice when uttering any certain sound. For instance, the difference between two speech sounds, such as B and D, was apparently not one of wave frequency. Any change in the number of sound waves would only raise or lower the pitch; however, the characteristic B and D sounds are distinguishable whether or not they are spoken by the highest soprano or lowest basso.

Mr. Flowers went into the study of this subject very exhaustively and, having decided that there were too many complicated side tones and irrelevant tones, such as fundamental and overtones produced by the vocal cords, he arranged an especially sensitive electrical device to pick up and record on a moving strip of film a whispered tone. It has been proven from many exhaustive experiments on a great number of persons of both sexes that these whispered tones in any case will correspond to a certain definite form or pattern for each letter sound of the alphabet. To make this matter clearer, reference is made to Figs. 1 and 2, where the characteristic intensity curve of the "B" sound is shown at 1, while the intensity curve of the "B" sound uttered at a lower pitch is shown at 2

It is observed that in both cases the letter sound pattern is the same and this fact Mr. Flowers succeeded in establishing beyond any question. He has succeeded, with the aid of the apparatus shown at Fig. 3, in producing a complete alphabet of equivalent phonetic, letter sound patterns, as indicated at Fig. 4.

Referring again to the apparatus employed for studying the characteristics of human speech, as shown at Fig. 3, there was utilized an Einthoven galvanometer with silvered quartz fiber which was caused to vibrate by the current generated in a secondary of a step-up induction coil, as illustration indicates. The primary of the induction coil was connected in series with a telephone receiver (used as a check on the test conducted); a controlling resistance of approximately 500 ohms value; a single storage battery cell and an Acousti-

a fine silver-plated quartz fiber .0001 of an inch thick, supported between the two poles of a very powerful electro-magnet. The ray from the arc lamp was focused upon this quartz fiber through a hole in the magnet poles, and by means of a second system of lenses the image of the string was photographed as a spot on the rotating drum of the camera. Whenever a sound was whispered in the proximity of the Acousticon microphone the latter varied the current of the primary and conjointly the secondary current of the induction coil and which effect was manifested in the galvanometer by the string vibrating more or less in accordance with the strength of the sound and its particular letter characteristic.

When the shadow of the galvanometer string moved back and forth about two inches

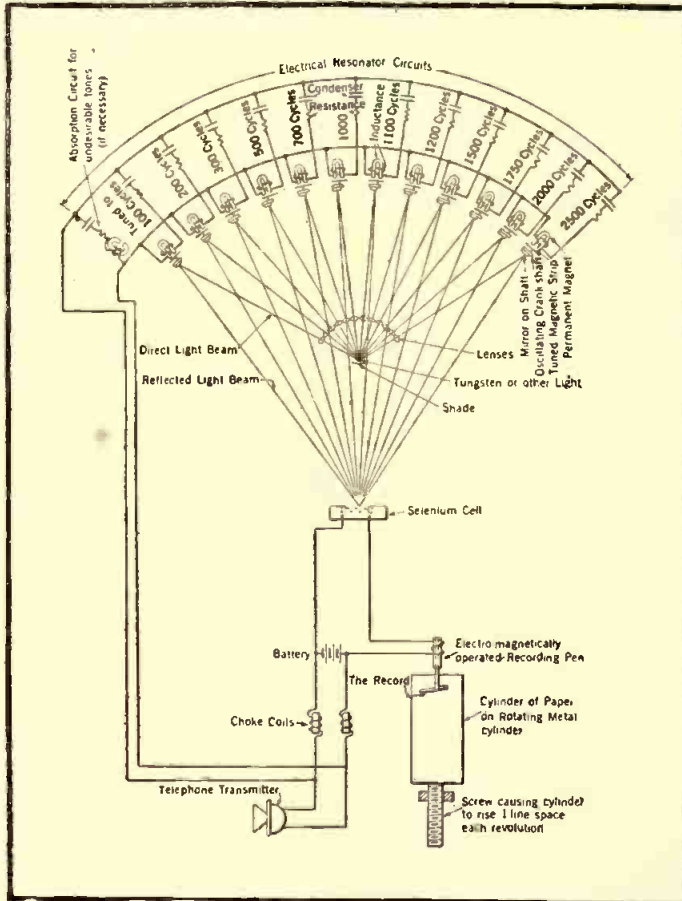

Fig. 5. Arrangement of Electrical Circuits and Allied Devices Used in Writing the Spoken Word Directly.

con microphone or transmitter. As is generally known, this transmitter is used to a great extent in aiding partially deaf people to hear better, and it is so remarkably sensitive to sound waves that *whispers* have the same effect as would the ordinary tone of voice on the standard microphone supplied with the common Bell instruments.

An arc lamp was used to give a strong beam of light, which was intensified through a series of lenses, with the result that the slightest motion of the galvanometer string was magnified 900 times when it reached the recording film in the camera observed at the right of Fig. 3. The galvanometer string consisted of

When the shadow of the galvanometer string moved back and forth about two inches the electrically operated camera shutter was opened for one revolution of the wheel and a five-foot photographic record of the word whispered was thus obtained. While many speeds, even as high as one mile per minute, were tried, the rate of 1,080 feet was found suitable for most of the work. The light from the arc was interrupted 500 times per second, and in this way vertical lines were automatically photographed on the moving film at intervals of two-thousandths of a second, by virtue of a specially constructed time wheel.

Mr. Flowers, in speaking of his work in this direction, states that speech patterns so photographed on the moving film and of the same identical sound are practically exactly alike for all persons and independent of their age or sex. In this fashion 500 different records were obtained of three men's speech and one woman's to substantiate the arguments here set forth. This work was conducted by the co-operation of the Department of Physiology, College of Physicians and Surgeons, New York, and the Underwood Typewriter Co., so that unequalled facilities were at hand in this most remarkable study of the human voice and its fluctuations.

In the present instance the investigator decided that, knowing exactly the particular curve corresponding to each letter of the alphabet, when uttered by any person regardless of age or sex, he would do very well to perfect or design a machine which would trace out exactly these differ-

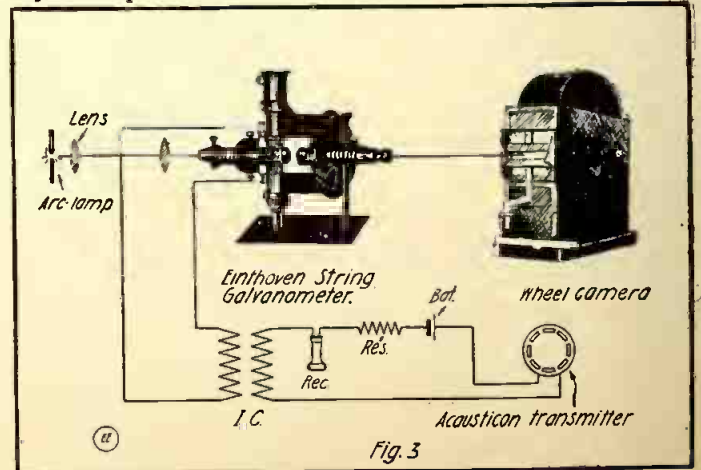

Fig. 3. Using an Einthoven String Galvanometer and Special Camera to Photograph Whispered Speech.

ent curves if anyone should speak to it. Accordingly, he has evolved a scheme as perceived at Fig. 5. This machine, it should be said at the start, utilizes a stylus or pen which writes or traces out the curves as shown in the phonetic alphabet at Fig. 4, corresponding to each letter of the English alphabet. Hence, if this was to be used commercially or otherwise, it would be necessary for those making use of such a "phonoscribe" (if we may so term this device), to learn this alphabet or else to employ a transcriber who could read it. Needless to say, it could be easily memorized, just as the notes of a musical composition are or the characteristic sounds of the letters employed in the study of foreign languages.

The voice-controlled phonetic typewriter as here outlined makes use of a selenium cell, which cell has a blank space at the center of its face. Ordinarily the beam of light caused to strike this cell rests on this blank spot. In operation a person speaks into the telephone transmitter or microphone and any current undulations thus set up in its circuit are prevented from reaching the stylus mechanism by the choke coils inserted between the batteries and microphone. Hence the current variations produced by the microphone, when spoken into, will proceed to the series of tuned circuits employing different values of inductances and capacity and arranged in the segment of a circle, as observed. These tuned circuits include a specially tuned resonator of the magnetic type. This comprises a pair of electromagnets in front of which is mounted a tuned magnetic strip, as indicated at Fig. 6. This resonator, which is tuned for any one tone of speech at any instant will therefore respond, likewise the current existing in it at any moment will vary in strength according to the speech variations at the microphone. Thus when the proper resonator responds to the corresponding letter sound the magnetic strip will vibrate powerfully, which will cause the connecting rod shown in Fig. 6 to oscillate the delicate shaft there shown. The connecting rod is secured to the shaft only .004 of an inch from the center line of same. It is thus possible to create an angular motion of the shaft of 1 1/2 degrees when the magnetic strip has a given motion of but .0001 of an inch. Furthermore, a mirror attached to the shaft will move or oscillate with it, causing a beam of light from a tungsten or arc lamp (as indicated in Fig. 5, and passed through a series of

at the center or on the blank space on the face of the selenium cell. When the reflected beam of light begins to oscillate it swings back and forth past this central

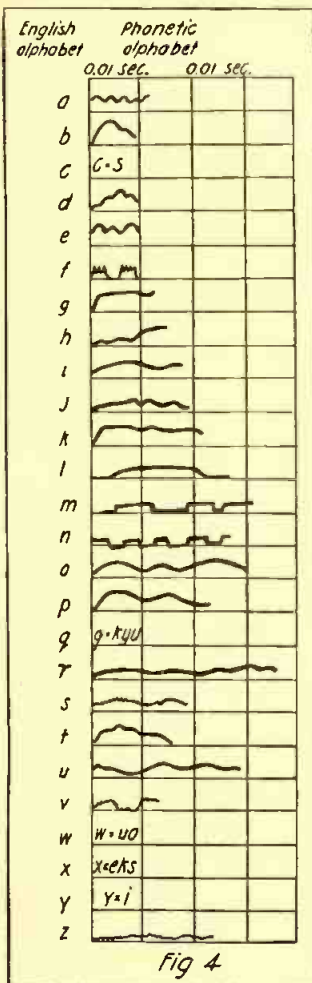

Fig. 4. The New Phonetic Alphabet Evolved by Mr. Flowers.

responding to the letters in the make-up occur consecutively, the recording pen of the "phonoscribe" thus writing out in a continuous line the connected sounds, as it were, of each letter in the word.

NEW USES FOR TELEPHONES.

Further experimentation on the loud-speaking telephone for railway train dispatching work has resulted in a loud speaker that is an unusual combination of distinct enunciation and large volume. A number of these instruments have been installed during the year on many of the lines of important railroad systems, where they are doing efficient work.

A new type of hand telephone has been developed in collaboration with the United States Forest Service for use in forest service patrol work. This hand set is a complete local battery telephone set which weighs only 2 3/4 pounds, making it the lightest satisfactory portable local battery set obtainable. The omission of a hand generator makes this possible.

Signaling of other stations on the line is done with an interrupter mechanism which operates a howler, connected at the permanent station, in addition to the regular bell of the stationary telephone. It is possible with this equipment to send a howl over a longer line. The hand set consists of a transmitter, receiver, induction coil, battery, signaling interrupter and talking and signaling push buttons.

GASOLINE-ELECTRIC TRACTORS HELP CLEAN NEW YORK CITY STREETS.

For some time past the New York Street Cleaning Department has been trying out various tractor and trailer combinations for the collection of ashes, garbage and street sweepings, as well as for mechanical sweeping and flushing of streets. The experience gained in this experimental work showed that while the electric tractor was highly desirable from the standpoint of operating simplicity the mileage limitation imposed by the storage battery equipment was a handicap. Further, that because of the many stops in collection work (60 to 100 per hour) the gasoline tractor with gear transmission clutch, spark and throttle control was not only impractical, but presented the disadvantage of greater complication, with the resulting necessity for a higher class of drivers.

It has long been appreciated that the real work of street cleaning and flushing must be done at night, and the collection of refuse during the day. This calls for at least 16 hours service in 24.

A type of tractor which would be capable of practically continuous operation and adaptable to either kind of service was evidently necessary. A tractor equipped with a gasoline engine driving an electric generator, whose output could be used in motors driving the rear wheels, was accordingly chosen as having the simplicity of control of an electric vehicle and the relatively large mileage capacity of "straight" gasoline equipment. This combination also presented the advantage of providing in the most convenient form energy for driving the auxiliary apparatus used in street sweeping and flushing.

Twelve such tractors are now in use by the Department of Street Cleaning in this city.

The electric motors are suspended by links from extensions of the rear spring hangers and by extensions of their cases which bear on the rear axle. The motors drive by spur gears to intermediate shafts, which carry pinions engaging with internal ring gears mounted on the rear wheels. The use of pressed fabric pinions on the motor shafts has resulted in extremely quiet operation. The motors themselves are, except for the special cases, of the standard automobile type with ball bearings.

A 40-horsepower gasoline engine was thought to be a proper selection. The engine used in the tractors is a four-cylinder type. A centrifugal governor maintains a rotative speed of 900 r. p. m., this latter being the rated speed of the electric generator.

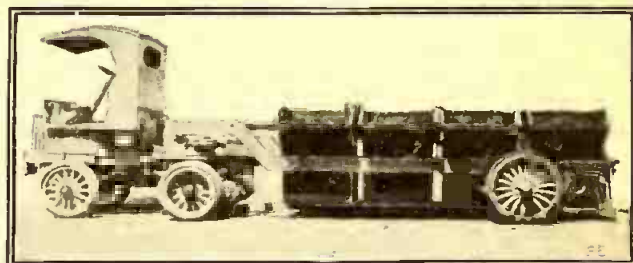

Gasoline Electric Tractors Clean New York City Streets.

The generator is rated at 15 kilowatts, 125 volts, 120 amperes at 900 r. p. m. The electric wiring is all carried in metal conduit, and the controller, cut-out switch and ignition switch are placed in a sheet-steel box beneath the driver's seat.

In Zurich, Switzerland, street cars are run by liquid air.

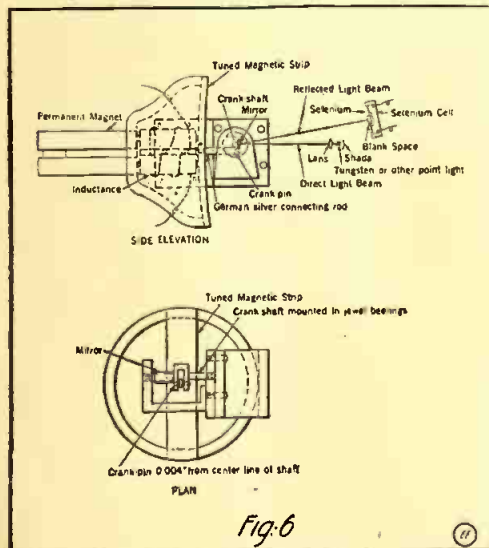

Fig. 6. Details of Tuned Magnetic Resonator and Reflecting Mirror.

lenses) to be reflected on the selenium cell aforementioned. As stated, normally the spot of light rests

How to Talk Into the Telephone

By Robert W. Phelps

"HELLO! Hello! Hello! can't hear you. Talk louder, please!"
How often do you say this when you cannot understand the party on the other end of the telephone? The party on the other end of the line raises his voice and yet the voice sounds as if from afar.

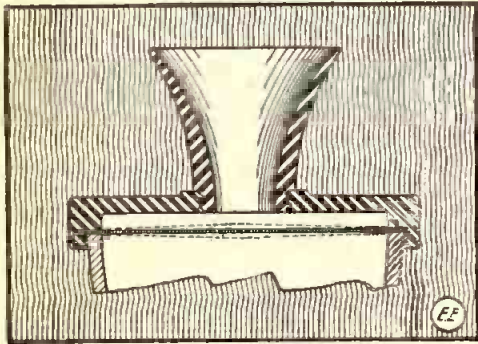

This diagram of the mouthpiece of a telephone transmitter illustrates how the diaphragm vibrates. The greater the intensity of the voice the greater the intensity of vibrations of the diaphragm and the electric impulses sent over the wires.

You shake up the telephone transmitter and he does the same. Sometimes this obviates the trouble and sometimes it does not.

Possibly you frequently converse with a party with whom you invariably experience difficulty in hearing his voice plainly through the 'phone. You know that this party usually talks directly into the mouthpiece of the transmitter so loud that he can be heard for several rooms about, and yet his voice sounds very faint at your end of the telephone.

Possibly you also talk with another party who sends every word through the telephone as clear as if he were speaking directly into your ear. And, further, you have seen him using a telephone, speaking in a low tone that was hardly audible 10 feet away. Why is one party so plainly heard, speaking with but little effort, and the other with so much difficulty?

A little knowledge of sound and its application in telephoning will save much annoyance in telephone conversation, as well as do away with much unjust condemnation of telephone companies for poor service.

Sound is the impression produced on the ear by the vibrations of an elastic medium, such as air. Such vibrations radiating from a source are spoken of as *sound waves*. Sound waves travel in air at the rate of about 1,100 feet per second. The length of the wave determines the pitch of the sound. That is, the greater the number of waves striking the ear per second, the higher the pitch. The height, or amplitude, of the wave determines the intensity or loudness of the sound. At the point at which the sound originates the intensity is the greatest, and its intensity decreases as the wave travels. The velocity remains the same from the time the wave starts until the intensity becomes nil.

Each note on the musical scale has a definite number of vibrations per second. As an example, middle c, designated as c' in the accompanying musical scales, has 256 vibrations per second. The note one octave higher, designated as c'', has 512, just twice as many as middle c. The note c, one octave lower than middle c, has but 126 vibrations per second, or one-half the number of middle c.

In general the number of vibrations per second are doubled when the pitch of sound is raised one octave.

Ordinarily the higher the pitch of sound, the less the amplitude of the wave. When the higher notes have the same intensity as the lower notes they become shrill and unpleasant to the ear. It will be noticed that when a soprano singer reaches for the higher notes, the tone is more pleasing to the ear when not sung loudly. How different with the basso.

Now let us glance at the diagram illustrating the propagation of two sound waves for the same length of time, but one having a pitch of one octave higher than the other. In the same length of time the higher pitch has twice the number of vibrations as the lower. In tones of the same quality the intensity of the waves X is about one-half that of waves Y.

When these waves strike the diaphragm of the telephone transmitter the higher pitch causes the diaphragm to vibrate with twice the rapidity of the one an octave lower in pitch. The higher pitch does not cause it to vibrate with the intensity of the lower pitch, for two reasons. The first is, that the wave of the higher pitch does not have the amplitude of the wave of the lower pitch. The second reason, which is probably the more important, is that each vibration of equal intensity of the diaphragm absorbs about the same amount of energy. Therefore the diaphragm absorbs twice the energy to overcome its inertia, when vibrating in the higher octave, than it does when vibrating in the lower octave.

It should be kept in mind that there are two diaphragms in a telephone instrument—one in the transmitter and one in the receiver.

With the above knowledge of the rudiments of sound and its application to the use of the telephone, the natural conclusion is that the lower the pitch of the voice at the transmitter the more audible will it be at the receiver of the telephone. When not understood over the 'phone, one should, therefore, lower the voice, rather than allow it to rise to a higher pitch. Try it the next time you use a telephone and watch the results.

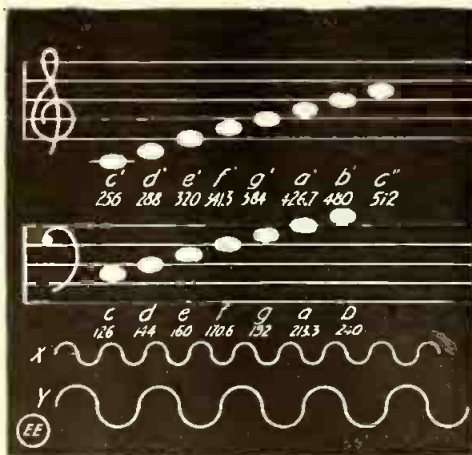

Every note on the musical scale has a definite number of vibrations per second, as indicated above. It makes no difference how loud or how soft middle "c" is sung, it always has 256 vibrations per second. Each octave difference in pitch, going up the scale, doubles the number of vibrations per second. The two lower curved lines represent sound waves having a difference of one octave in pitch, but of the same quality. The upper wave is the higher pitch.

YOU CAN PHONE THE CHEF NOW

"Hello! Give me one 602, a little 312, two 874 and a cup of 302."

No, these are not the signals of a football quarterback; they are simply the indications of a fairly good appetite as expressed over the special restaurant tele-

phone system installed by the Ritz Co., which runs a lunch room in Plainfield, N. J. Instead of using waiters to take patrons' orders, the company has equipped its restaurant with telephones. One of them *waits* patiently at every table. The



"Phone the Chef," the latest fad in restaurant novelties.

lines from these tables are connected with the kitchen.

The operation of the system is simple. When the patron takes his seat at the table he studies a menu whose dishes are indicated by numbers. When he has made his selection he picks up his telephone and gives his symbolic order to the chef.

Photo courtesy of Western Electric Co.

"PAUL REVERE" VIA RADIO.

The preparedness and skill of the 25,000 licensed amateur wireless operators of the United States was tested by Uncle Sam on Feb. 21, when a message appropriate to the celebration of Washington's Birthday was sent to William H. Kirkwin at the licensed station "9XE" for transmission throughout the country. The message, which was dispatched at 11 o'clock, was picked up by all stations within 300 miles of Davenport and relayed in every direction for transmission to the governors of each State and the mayors of the principal cities. The message read as follows:

"A democracy requires that a people who govern and educate themselves should be so armed and disciplined that they can protect themselves.

"COL. NICHOLSON, U. S. A."

The message was read by boy scouts at Mount Vernon and at Bunker Hill.

The wireless message urging preparedness was duly received in Washington and delivered to the policeman who stood on guard at the White House office at 2 o'clock in the morning. He delivered the message to Secretary Tumulty for presentation to the President.

On account of the number of relays, it required about an hour and a half to send the message from Davenport to the Pacific Coast, more than 2,000 miles from its starting point.

The message was characterized by some of those interested as "Paul Revere's ride done into wireless," as with the changing of the words it might have been utilized to call a nation to arms, much as Paul Revere called the Minute Men.

A surgeon in the Japanese army is reported to have invented a machine run by electricity that grinds as many beans into flour in 40 minutes as a man can grind by hand in a day.

NEW TWO-CELL ELECTRIC LANTERN.

A very practical and useful design of an electric lantern has recently been developed by an enterprising concern; it is designed to accommodate two standard dry cells instead of one. This of course gives much

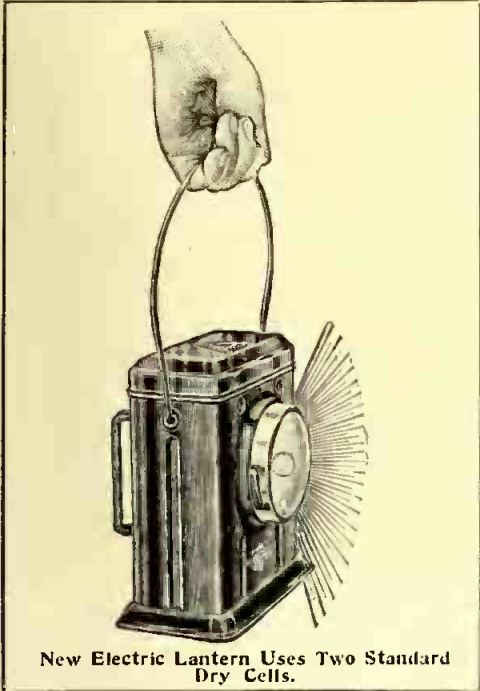

New Electric Lantern Uses Two Standard Dry Cells.

greater life to the lamp for a given candlepower, and also a larger bulb than that adapted to the single-cell style of lantern may be used.

The case is made from a steel shell which acts as a container for the batteries, and the bulb supplied with it is of the tungsten type with an efficiency of about 1 watt per candlepower. The lamp is fitted with a 3¼-inch silver-plated reflector, designed to throw a well-diffused light over an arc of 180 degrees, but especially concentrated beam reflectors can be furnished if desired by the purchaser.

A powerful concave-convex lens 3¼ inches in diameter is fitted in front of the reflector and tungsten lamp.

The case is neatly finished in baked black enamel with trimmings of polished nickel. The manufacturers of this latest type electric lantern for the utilization of dry cells claim that it gives steady service and it sells for a very nominal price commensurate with the high quality of the workmanship and materials involved in its construction.

NEW TOY TRANSFORMER HAS CIRCUIT BREAKER ON IT.

A progressive manufacturer of toy step-down transformers suitable for reducing 110-volt, alternating current lighting cur-

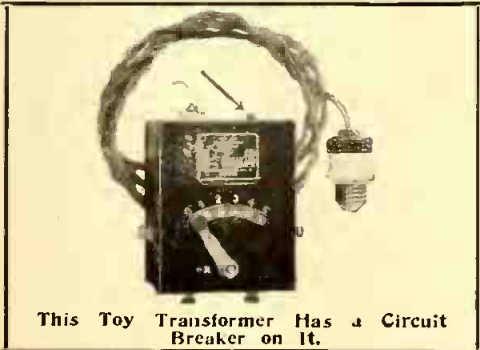

This Toy Transformer Has a Circuit Breaker on It.

rent for running toy railways, etc., has at last developed an important detail on this much-used device, which promises to be a boon to those making use of such appa-

ratus. This improvement is in the form of an automatic circuit breaker which opens the primary circuit of the transformer; i.e., it disconnects the 110-volt current whenever the secondary of the transformer is overloaded, such as by a short-circuited section of toy railway track, etc. The circuit breaker will continue to trip open, no matter how often it is reset, so long as the short-circuit exists across the secondary of the transformer. The illustration herewith shows the appearance of this attachment and the transformer complete. The circuit breaker is reset by means of a small push button, to which the arrow points. The secondary is adjustable for different voltages by means of a switch, as observed, and undoubtedly this innovation will be highly appreciated by those having to make use of this important piece of apparatus, which is much in demand for operating small battery motors, t y railways, low-voltage lamps and other miscellaneous toys and devices.

BATTLE CREEK, MICH., HIGH SCHOOL WIRELESS CLUB.

The High School Wireless Club resumed activities with the opening of school in entirely new quarters. The operating room has been moved from the physics laboratory in the basement to the observation dome at the top of the building, and the work of reinstalling the instruments and wiring recently completed makes this one of the best sets in the State.

Forest Phippany, Dale Ball and other members of the club at the high school building for some time preparatory to the change, and they now have things in shape for a busy season.

The European war and recent ocean disasters have aroused a keen interest in the wireless telegraph and there are a dozen stations in Battle Creek now. A number of the members of the high school club have stations at their homes. The high school station and many of the others here catch messages from Arlington, Va., and other far-away points, and have a sending radius of from 100 to 200 miles.

With the wireless room in the dome of the building, away from the noise and confusion from the streets and corridors, it is thought that the efficiency and range of the station will be greatly increased. A number of new parts have been installed and the old sending and receiving apparatus, which is standard in every particular, has been completely overhauled.

AN ELECTRIC FOUNTAIN.

It is often desirable to complete the decoration of a room or restaurant in an attractive manner by utilizing a small foun-

tain, but until quite recently this was impossible on account of the numerous pipes necessary to conduct the water supply to and away from the fountain.

The only natural solution of this problem lies in using the same water over and over. To accomplish this end the fountain here illustrated has been brought out.

This beautiful display may be placed in any position, anywhere, and requires nothing but a cord connection to the nearest electric light socket in order to continue its action indefinitely, or as long as the current is turned on.

The base of the apparatus contains a motor-driven pump which forces the water up through the several jets surrounding the figure, as observed. The water then falls back into the large basin around the



Electric Fountains Are Now Available in All Sizes for Parlor or Dining Room Decorations.

foot of the figure and flows to the pump again, only to continue the same cycle. The water is prevented from splashing by means of this large basin, specially designed.

The design here pictured measures 24 inches from the top of the figure to the base, which is 15 by 12 inches. The jets of water reach a height of 30 inches, which is sufficiently high for use in a conservatory or a large room when the fountain is placed on the floor.

The motor operates on either an alternating or direct current circuit. The current consumed is very small; the actual cost of operating the fountain is about 1 cent per hour. The apparatus will last indefinitely and should prove a real asset around country homes or hotels. There is nothing more beautiful or ornate than a water fountain for interior decorations, dinner spreads, balls, parties.

A MUSICAL GARDEN WALL.

By Albert Marple.

A loud-talking telephone is one of the most recent electrical inventions of Earl C. Hanson, the 22-year-old inventor of sunny Los Angeles. The function of this loud-talking device is to take the sound of the human voice or the music from a phonograph or other instrument and multiply it as many times as desired. This effect is secured by means of an amplifier, which after several years of hard work has been highly perfected by this young inventor. The extent to which the sound may be multiplied is governed only by the amount of electrical energy employed.

The work of this instrument may be more definitely understood if the description of a recent test is given. Incidentally, it may be stated that this instrument has been given a number of try-outs recently in and around the city of Los Angeles, and wherever the wonders of the device have been heard the instrument has proven a sensation. The principal demonstration was held at the country home of one of the most prominent judges in southern California. On this occasion the "central station" was the music room in the beautiful

It is not claimed by Mr. Hanson that this is the first time that phonograph music has been transmitted over the telephone, but he does declare that he has invented an amplifier which will increase any volume of sound many times.

The inventor believes that the field in which this new device could most profitably be used, in his opinion, is in connection with park concerts given by the municipality. For this work a "central station" could be located near the center of the city, with receiving stations at each of the public parks within the municipality's borders. At any given time during the day or evening a concert of phonograph selections played at the "central station" could be reproduced simultaneously at all of the parks within the system or circuit, the only expense to the municipality being for the employe who operates the phonograph.

With the exception of the amplifier there is nothing complicated about this "loud-talking" system. It is of ordinary telephonic construction. The music from the phonograph is played into one or more regular telephone transmitters. From these transmitters (marked X in photograph) it is carried by wire to the amplifier, which intensifies it as greatly as desired. From this instrument the sound, greatly augmented in volume, is carried over a double wire to the various receiving stations.

There is another feature about this apparatus or system which is of interest. When operated from the receiver to the transmitter ends it has the effect of a "dictagraph." While for those sentimentally inclined music in cozy corners and nooks is admirable, a disadvantage with the machine is that it would be dangerous for lovers to whisper "sweet nothings" nonchalantly, for the slightest sound is carried back to the "central station," where it is amplified and may be distinctly heard by the operator.

WIRELESS KILLS WOMAN.

Wires from an amateur radio telegraph apparatus sagging down and coming in contact with a live wire of an electric light plant recently killed Mary Roskinsky, a servant, employed in the family of Chas. Abrams, living at 518 Fourth avenue, Astoria, L. I. The wireless apparatus belonged to Mr. Abrams's son, Herbert Abrams, 18 years old.

He had an apparatus run by dry batteries set up on a small table in his bedroom in the rear of the second floor. The victim's right hand grasped the key of the instrument while her left hand clutched one of the wires which had been grounded on the steam radiator within one or two feet of the table.

The police found that the boy, in equipping his plant, had run his aerials out of the back window of his bedroom from the rear of his house for a distance of about 100 feet. During a recent storm the wires were weighted down by snow and became slack, so that in a light wind they occasionally knocked against a primary wire of the New York & Queens Electric Light Co. which was carrying 2,400 volts. Just why the girl caught hold of the key of the wireless apparatus is not known, but it is thought she probably started in to clean around the table and was in the act of moving it when the aerial wire sagged down and came in contact with the heavy feed wire below. In the shock she suffered the table upset and she was killed.

AUTOMATIC 'PHONE USED IN NORWAY.

The Norwegian Government is planning for an automatic telephone exchange in Christiania, and the first of the kind in Norway.

SPEED COUNTER AND STOP-WATCH ELECTRICALLY CONTROLLED.

An extremely useful device in the line of stop-watches and speed counters, which are widely used by engineers, machinists and others, is incorporated in the electrically

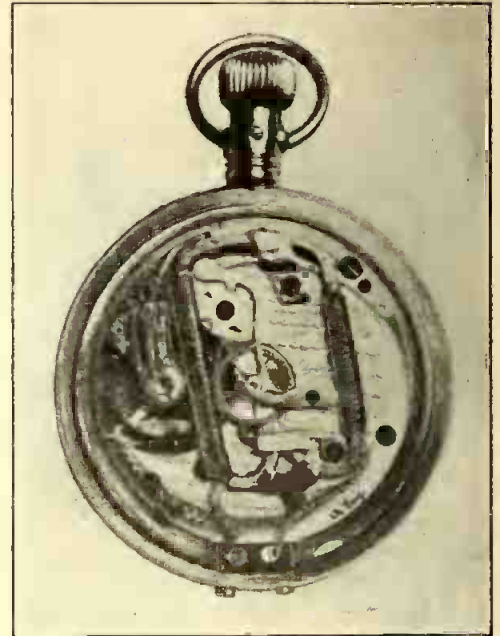

Electro-Magnets Accurately Control This Stop-Watch.

manipulated stop-watch perfected by Frederick A. De Lay.

The illustration herewith shows the interior mechanism of this electrically operated stop-watch. A small electro-magnet is mounted on the regular movement of same, as perceived. It is so arranged that the sweep hand engages when the circuit is open and becomes disengaged when the circuit is closed. This particular arrangement and refinement permits of very accurate timing of any operation in which the starting and stopping action can be made to open and close the circuit of the electro-magnet.

When this unique electric stop-watch is used with a revolution counter they are interconnected electrically, so that as the counter dial starts to turn the electrical circuit hooked up to the stop-watch is automatically opened and thus permitted to start same. The watch and counter automatically stop at the same time, since stopping the counter's shaft again closes the electro-magnet's circuit, which includes a small flashlight battery contained in the metal case attached to the counter. It is understood that the electro-magnetic attachment here devised does not interfere in any way with the use of the watch as a time-keeper or as a manually operated stop-watch.

The cost of this outfit is quite nominal

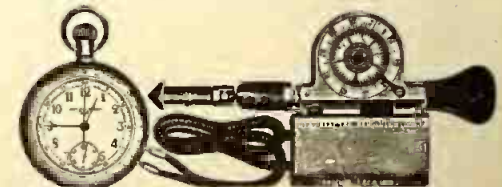

Stop-Watch of Type Above Depicted with Speed Counter and Electric Circuit Controller for Same.

and it should appeal to electricians, machinists, inspectors and others who have to do with the testing of any machinery, and, besides, there are many diversified applications to which this ingenious and accurate timing arrangement can be adapted, as, for instance, the timing of horse and foot races, train velocities, et cetera.



Above: Loud Talking Telephone Placed in Garden Shrubbery. Below: Cross Indicates Amplifier Microphones Placed in Phonograph.

dwelling, and the receiving stations were located at various points throughout the grounds surrounding the home. The moment the phonograph in the music room was started the gardens, several hundred acres in extent, were filled with sweet melodies, grand opera arias, popular selections and instrumental pieces, following one another in rapid succession.

Over all parts of the garden the music could be heard just as distinctly as could the phonograph at the central station. In the garden this music seemed to come from a beautiful border hedge, at another point it seemed to drift from a mammoth rose vine, while at another point the music waves seemed to come from the wide-spreading branches of a beautiful pepper tree. The telephonic receiving stations, were hidden from the view of those in the garden, and to each receiver was attached a small megaphone. As the ranges of sound from the various receiving stations overlapped it seemed for all the world as though the very universe was filled with music.

Timing Your Telephone Speech

By Frank C. Perkins

The accompanying illustration shows the use of a novel form of meter recently developed for timing long distance and toll telephone calls. It is pointed out that time and money are lost because of inadequate means of checking toll calls. An instance is given below:

A Philadelphia genius called at the office

rather than on the telephone company—yet it does both. It enables one to use all the time paid for, and one can more readily concentrate the mind on the message, instead of thinking about possible excess charges. It enables one to talk more leisurely and often do a little "visiting" over the wire after finishing a business message.

This instrument is also a check on interruptions, as it enables one to stop the time until the connection is restored. If the operator knows that one has a "phone-meter" she will not charge for the loss of time resulting from broken connections. The lost time on two or three calls often amounts to more than the price of the instrument.

WORLD-WIDE RADIO 'PHONE.

Wireless telephony will soon extend around the world. Secretary of the Navy Daniels told guests at a banquet given at the Lotos Club recently in honor of John J. Carty, who has succeeded in extending the uses of the wireless telephony.

"We thought until recently that wireless telegraphy was the last of modern miracles that had to do with communication," said Secretary Daniels. "Recently the world was amazed when from Washington, without wires, the human voice was heard in San Francisco. When fully perfected, we may talk to our friends 'from Greenland's icy mountains to India's coral strands.' The man whose genius is making this miracle possible is Mr. Carty." At the banquet table were telephones connecting with the wireless stations at San Francisco and elsewhere.

NEW ELECTRIC WHISTLE AND HIGH VOLTAGE PUSH BUTTON.

Most every one has heard and seen the ordinary steam or compressed air whistle,

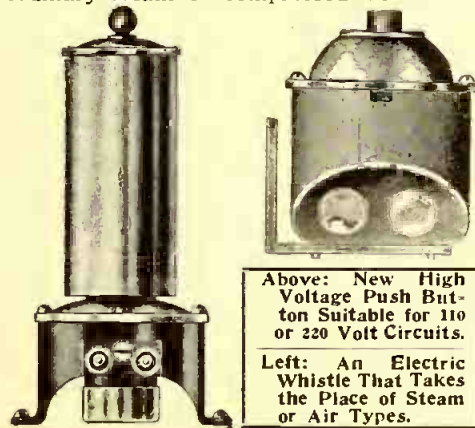

Above: New High Voltage Push Button Suitable for 110 or 220 Volt Circuits.

Left: An Electric Whistle That Takes the Place of Steam or Air Types.

but the electric whistle is a somewhat new device, so it seems. The illustration herewith shows one of these perfected devices, which operates on either 110 volt or 220

A PEAK READING VOLTMETER.

One of the leading American manufacturers of electrical measuring instruments has recently brought forth what is termed "a peak reading voltmeter." This instrument has been in great demand in the past and will undoubtedly find considerable adoption in the future. This meter affords a practical means for determining the maximum voltage on any alternating current system, reading the potential direct and always independent of the form of

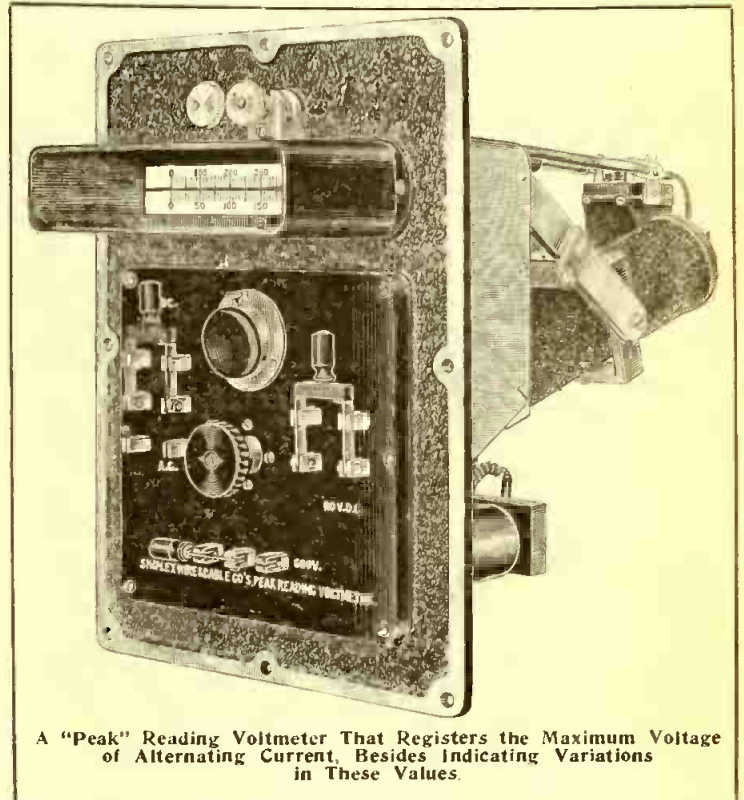

A "Peak" Reading Voltmeter That Registers the Maximum Voltage of Alternating Current, Besides Indicating Variations in These Values.

the wave, besides indicating the maximum voltage at all times.

As the meter also shows variations of the maximum voltage, it serves as an indicator of distortion of the wave form. It was particularly developed for use in connection with high tension cable testing, where, due to the capacity load, distortion of the wave is very likely to occur. It is, however, applicable to any alternating current apparatus or system, where a quick and accurate knowledge of the maximum voltage value is required.

In contradistinction to the ordinary voltmeter, this instrument reads the highest voltage attained by any wave of commercial frequency, while the instruments generally used for measuring alternating current potentials indicate the effective value which, of course, is about 30 per cent. less than the maximum or peak voltage of the current passing through the circuit. The common 110-volt a.c. lighting circuit, for example, has a maximum peak potential of about 155 volts.

volt a.c. circuit, or from a 10-volt battery circuit. These whistles operate on the principle of a vibrating diaphragm.

To control such devices as this is naturally beyond the province of the ordinary push buttons used for bell circuits and the like, so a special type of high voltage push button, shown in the second illustration, was perfected. This button is practically the same size as the ordinary bell push. In the illustration it is shown fitted onto a special conduit box designed for use with it. These buttons may be used for operating 110 or 220 volt circuits controlling horns, bells, lights, elevator systems, motor control circuits, etc.



Unique "Minute Timer" for Telephone Users. Especially Valuable on Long-Distance Calls.

of a business friend and found him engaged in a long-distance conversation with a factory manager. The business man rang off and turning to his visitor, said:

"Three minutes is not time enough for a long-distance call. I must concentrate my message into a very few words or else pay for excess time."

A few minutes later a salesman in Boston was on the wire. The visitor timed the conversation. It consumed a minute and a quarter. This business man, therefore, paid for six minutes of service, but used less than three minutes. This occasioned an actual loss of \$2.50.

A careful investigation has conclusively proven that only about 46 per cent. of the time paid for is actually used. The balance is pure waste, which means a real monetary loss to American business—amounting, in fact, to more than \$60,000,000 a year.

Whether one uses the long-distance service much or little, there is this waste. It is one of the few leaks in modern business that has not been checked. It became evident that there was a real need for a simple, yet effective, device for timing long-distance calls and increasing the telephone efficiency of business men.

The "phone-meter," here illustrated, is a neat little clocklike device, with a single hand and a specially designed dial. It is so simple and inexpensive that at first glance one can scarcely perhaps appreciate its great utility.

It will be seen that the "phone-meter" is a check on the person using the 'phone,

The "Live Wire"

By Adelbert H. Wolfe

Read This Article on the Live Wire.

It Explains How the Current Traverses a Conductor by Electronic Vibration

THE term live wire is often mentioned in speaking of high potential circuits.

There seems to be a mysterious phenomena surrounding it which impresses one of its importance. It is always considered as something dangerous to come in contact with, as it will severely burn, and if the amperage is sufficiently high will cause death to animal life. Let us consider this wire that possesses these dangerous and death-dealing qualities, and which will, if more current is added, melt, consume itself, and go up in smoke. The question is, how does this wire differ from any other wire lying around? Of course, you would readily answer that the above mentioned live wire is connected into a circuit, which is supplied with sufficient amperage and voltage to bring it to that high temperature in which it turns to molten metal.

Let us endeavor to learn more about this mysterious phenomena by taking for an example a battery, key and sufficient wire to complete the circuit, Fig. 1.

When the key K is depressed we know that current flows from the positive plate of the battery A, through B and down to the key K, passing through its points and back to the negative plate C of the battery. It was mentioned that current flowed from the positive to the negative plate in the external circuit, as that is the theory most generally used. But the writer feels safe to say that current not only flows from positive to negative in the external circuit, but also vice versa, or from negative to positive. The writer will take this up further in another part of this article.

Before we go any further let us refer again to Fig. 1 and answer a couple of questions.

1st. What is the condition of the open circuit before the key is depressed?

2d. What is the condition of the closed circuit after the key is depressed?

The above questions we will have to answer before we can determine what there is in the wire to make it heat.

In taking up question 1 let us first get at the bottom of the phenomena of electricity flowing through a wire. We know in the first place that everything material consists of molecules and atoms. The writer would like to make this article as simple as possible and deal only with molecules, but in dealing with current flow there is something else which we must take into consideration, and that is the electron. This very tiny germ of physical force is comparatively at home among the atoms and molecules of all metals and most liquids. It can easily penetrate a molecule and pass around through its atomic structure, tearing off a piece of an atom here and there. These tiny agents, the electrons, have the whole responsibility of transmitting the electric charges in a wire to their destination so far as we know. They are the electric charges themselves, and without them we would not have any electric current. They are the seat of current flow, that is, a positive particle is repelled by its positive neighbor and attracted by its negative one.

In case of question 1. When A B is connected to positive plate A and the circuit is open at K we need not think for an instant that the positive charges in the plate A of the battery remain there. No, as quick

as contact is made, they rush out through the new road of molecules and atoms seeking a way of escape, only to come at rest when the whole portion of the circuit from A to K is occupied.

Referring to Fig. 2 we have shown a portion of the circuit on a large scale; K represents the key points, C and A the negative and positive sides of the circuit, respectively. In C it will be noticed that the molecules nearest K are more darkly shaded. This represents a greater density of the negative electrons at that point. The same will be noticed in A, only that the shading is reversed, the white molecules denoting where the positive particles are dense. This massing of the positive and negative charges at K is practically true. It is similar to the massing of the "lines of force" at the poles of a magnet. The reader understands that the above movement of the charges is not current flow. But in case of A, Fig. 1, it is simply the positive forces lining up ready to rush into the negative neighborhood just across the key points. The same holds true for the negative side C.

Therefore in answer to question 1 we can say that the portions of the open cir-

in X was formerly in Y. This is how the forces travel through the wire, each force borrowing from the molecule ahead of it an equal quantity of the force of the unlike sign and replacing it with itself. Thus it keeps on this free exchange until it reaches the battery plate, where it is acted upon by the chemical solution. Or in the case of a dynamo being the source of energy it finds its way back to the original armature coil from which it started.

In the above movement of tiny electrons the combined movement, which we call an electric current, the molecules of the medium through which they pass, whether it be metal, earth or water, are not practically displaced, but it is their atomic structure that is in turmoil, and as the amperage increases the greater the decomposition of the atoms will be. Also the more molecules are set into vibration.

Therefore in answer to question 2 we can say that after the key is depressed the structure of the wire experiences a molecular upheaval, as the tiny electrons or forces surge through its atomic structure decomposing them and giving to the wire, shall we call it, frictional heat.

It has taken years of experimenting to bring the live wire up to its present perfection. The great achievement of transcontinental talk over a telephone wire has been perfected. But taking it altogether the wire is nearing the end of its victorious life.

It has climbed, rung by rung, up the ladder of invention and fame and deserves a good share of the glory in the electrical field. For without it all the great electrical inventions would have been impossible. For example, without the electro-magnet there would never have been any dynamos, telephones or telegraphs. No, not even our wireless telegraph and telephones. These two latter inventions, which the wire has helped to bring about, have paradoxically dealt it the most telling death blow.

Since the trans-Atlantic radio telegraph and telephone are a fact, it no longer requires the "cables" that are lying on the ocean bed to spell out the message in Morse code. It is this new thing that man has invented, the "electro-static wave," that can cause the message to be transmitted across the water with the speed of light (186,000 miles per second).

It is this ethereal agent that is the wire's most deadly opponent. The "cable" is no longer required; its extent is reduced to the length of the wires in the "aerials" on either side of the ocean. This is the wire's one great defeat and others are soon to follow.

The wire must give place to the ether wave. The victory gained by the latter will be slow, but nevertheless will be complete in the end, as Nikola Tesla claims.

What wire used then on apparatus, if any, will be of such a small amount that it will become nearly, if not wholly, obsolete.

BRAZILIAN RADIO ACTIVITIES.

The Brazilian Government has decided to erect wireless telegraph stations in the Rio Grande do Sul Santa Catharina, Sao Thome, Cruziero do Sul, Senna Madureira, Rio Branco, Sao Luiz de Caceres and Porto Murinho. Steps are being taken to organize a general scheme of radio telegraphy, both on the coast and in the interior.

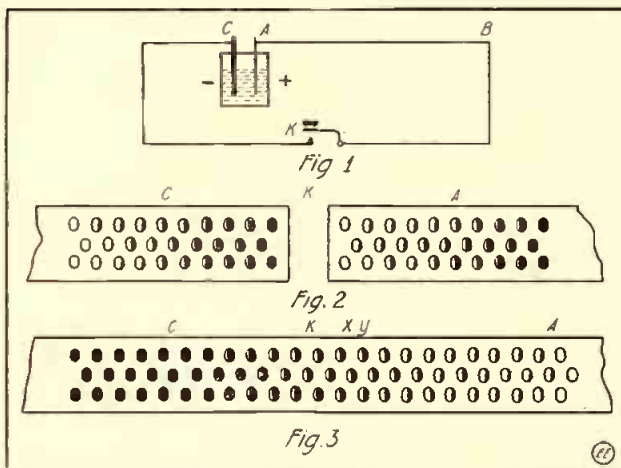

Diagram Indicating How Electrons in a Conductor Communicate a Charge from One Molecule to the Next at the Marvelous Velocity of 186,000 Miles Per Second.

cuit A B K and K C are seats of potential energy, each having, respectively, their positive and negative forces massed together, but held in check ready to launch themselves into each other at the touch of the key. It is understood that if the voltage was sufficiently high the key points would be bridged and the conditions of the circuit would be the same as if the key had been depressed.

In case of question 2, the moment that contact is made the positive and negative forces that are waiting in the form of potential energy change places; the velocity of the flying forces is truly enormous. Fig. 3 shows K closed. At this instant the opposite forces that are nearest K intermingle, as is shown in the figure directly below K. In this section of the wire it will be seen that the molecules contain equal plus and minus charges. The negative half of the molecules charge is traveling in full force toward A, while the positive half is likewise traveling toward C. It is understood that the molecules are not moving, but the electrons in them. The latter use the molecules for stepping stones, jumping from one to the other in their mad rush back to their home battery plates.

Take for an example the molecules x y, Fig. 3. The negative charge in Y was formerly in X, as also the positive charge

Making Things

By Thomas Reed

DID your father ever tell you it "Doesn't pay to make anything yourself?" Mine used to. After watching me working like an ant to make a little whirly thing I could have bought for a dollar he casually figured up how much more quickly I could have earned that dollar by sawing wood, and bought the whirly thing. Did Rockefeller drill his own oil wells? No. He hired other people to do it. That's the way he got rich. But this tinkering idea of mine had no standing at all. Life was too short.

There was a little finesse in father's suggestion about the wood-sawing, because he wanted me to contract the wood-sawing habit; but apart from that his attitude was due to his being sore over a certain occasion when he took a hundred dollars out of himself trying to save five dollars. Rockefeller at that time was supposed to have made his fortune by not spending anything. Rockefeller theories keep changing, you know, just like atomic theories.

My father, good old man, never tried to make anything, or if he did nobody recognized it as such; but sometimes when he felt strong and had mused on Rockefeller, he would do a little repair-work around the house. I remember when he achieved his masterpiece in this line by mending a broken leg (on a chair, you know—he never dabbled in surgery).

Father had a very complete kit of tools, consisting of a hammer, a gimlet, a plane that got plugged up, and a baking powder can full of rusty screws; and there was a screwdriver in the sewing machine drawer, but that wasn't his, you bet it wasn't!

He retired to the cellar with the so-called tools, together with the chair, and we children kept out of the cellar because—well something in his manner told us he preferred it that way.

After a couple of evenings' hard labor he came up with the chair, and sure enough the leg was cleated on so it looked all right—though he said he guessed we had better not sit on it just yet. Evidently it was convalescing. He had broken his glasses, and his mind had got deeply peeved like a baby after a hard day at the beach. Mother had something she wanted to say to him when the children wa'nt round, about an expression that had escaped him inadvertently; and it did look from certain angles as though it would have been cheaper for father to buy a new chair, or go without and stand up.

But shucks, father, there is a joy in the sense of mastery when you accomplish a thing yourself which far out-weighs the paltry coin saved! (You understand I didn't really hand any such good counsel to father, I only thought it. The current of counsel in our family ran distinctly the other way. There was never any back-wash to speak of.)

But whenever I got a good laugh (in my sleeve) on father he was sure to get it back on me before long. For sometimes

in my early experiments the saving of my scanty hoard involved such a prodigious expenditure of energy that even to me the result seemed out of proportion—rather a small hang-out, as the fellow says, for so large a wash.

Long ago, when telegraph instruments were the correct thing in amateur circles, the Band of Young Edisons to which I belonged decided to put one over the neighboring bands by making up a real cast-brass set. We hung around the brass foundry and watched operations until we understood what we had to do, and then fell to with great secrecy, as this thing was to be sprung as a crushing surprise. We drew our designs from the pictures in the catalogs and saved out the patterns with the jig-saw, giving them the slight taper necessary for drawing from the mould, and sandpapering and shellacking them smoothly. So far all was easy, and even the "flask" for holding the sand presented no difficulties. The fine moulding-

in the family furnace, tenderly covered with a fat live coal, and with a forced draft, produced by bellows, fans, and lungs, we gradually forced the heat to the melting-point. The melting-point of the brass I mean; our own was passed far back along the road.

It was in the middle of winter; but before the pouring took place every window in the house was open and the heavy underwear of the family upstairs was scratching just as it does in spring. At one stage somebody started for the fire-alarm box, but was headed off just in time. The output, on a general cooling (of metal, house and anxiety) were a dozen small castings plentifully sprinkled with case-hardened iron particles which defied the file. The costs, as computed that evening by father, who was good at figures, totalled something like \$15. (Including coal and repairs to the furnace, but excluding the kettle, which had not at the moment been audited.)

But shucks! Hadn't we made the set? The satisfaction of making it was certainly worth more than a paltry \$15. If you have the "how-to-make-it" hug, you'll readily appreciate this.

U. S. WIRELESS TO CIRCLE WORLD.

A final step toward linking the United States with its foreign possessions through a great chain of wireless stations was taken recently, when Secretary Daniels, of the navy, approved a contract with the Federal Telegraph Co., of San Francisco, for the equipment of the big radio stations now under construction at San Diego, Cal. Cavite, P. I., and Pearl Harbor, Hawaii.

Completion of these stations within the next year will pave the way for radio communication from Washington not only to the insular possessions, but to almost any point in the world where there may be a receiving plant.

Plans are now being prepared by the Navy Department to increase the power of the existing equipment at Tutuila and Guam, so as to make them a part of this world wireless chain. The intermediate stations at Boston, New Orleans, Point Loma, Chicago and Guantanamo already have been strengthened and are able to relay messages from ships at sea to Washington via the Arlington, Va., towers.

Further advancement in radio development will be made this year at Charleston, S. C., San Juan, Key West, Puget Sound, Cordova and Mare Island.

The new stations at Pearl Harbor and Cavite will be the most powerful in the world. They will be equipped with apparatus for exchanging messages over an area of approximately 4,700 miles, the greatest distance ever attained by radio plants in daily use. Each will maintain direct communication with San Diego, the Canal Zone and the Arlington stations, and will be able to sweep the Pacific Ocean from the Philippine Islands and to Alaska and the Canal Zone.

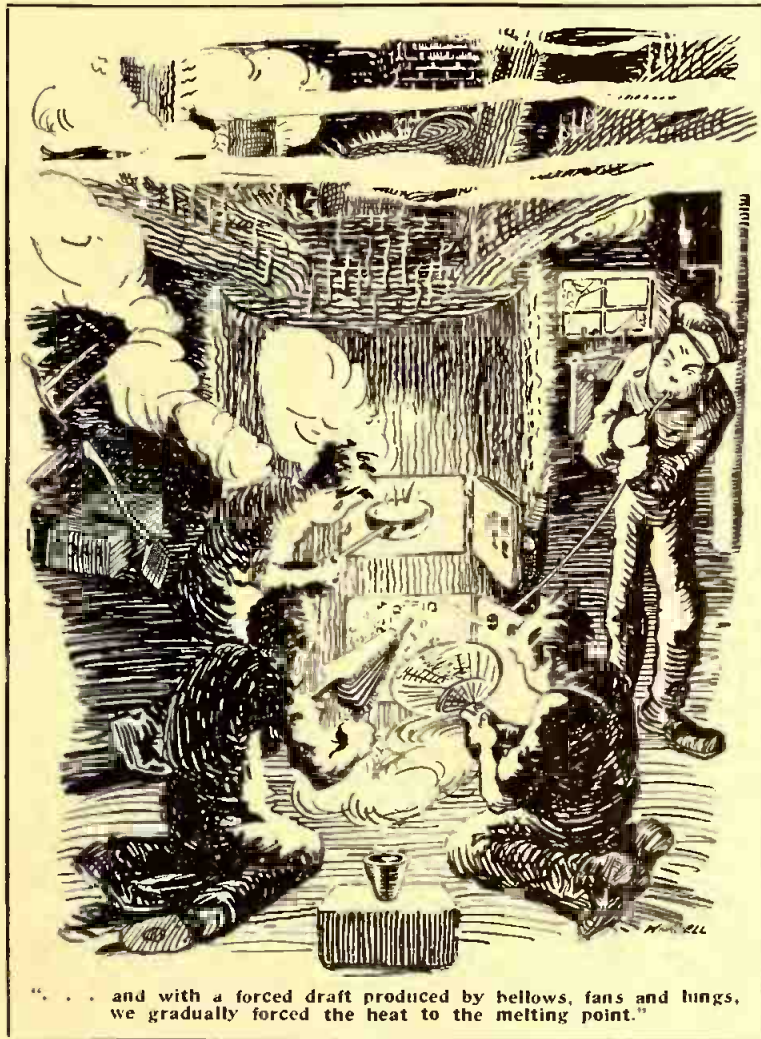

... and with a forced draft produced by bellows, fans and lungs, we gradually forced the heat to the melting point.

sand we begged from the foundry-men, who by that time were glad to get rid of us at any price; and after a few trials we were able to draw the patterns and form the sprues.

Then loomed up the melting of the metal; and the enterprise reached that always ticklish stage when some of the settled habits of the family must for the moment give way to the requirements of science. We collected all the old brass and copper on the premises (including one kettle that was missed and formed the subject of an investigation later). This metal in a black-lead crucible was placed

Use of the Braun-Tube for Research Work on Electric Oscillating Currents

By Prof. Dr. Ferdinand Braun, University of Strassburg i/Els.

By invitation of the editor of *The Electrical Experimenter*, I am pleased to give a short essay on the above mentioned subject.—Author.*

I WILL begin with a few words on the *Cathodic Rays*. Suppose you have a glass tube in which the air is rarefied to the extent of that existent in the so-

denser varies periodically, the point C will oscillate in syntony with the time period of the charges. It produces in this manner an oscillating light point on the wall. This will be green and relatively weak on glass; blue and very much brighter on sulphide of calcium, and a very bright green on sulphide of zinc.

when excited by a given electric or magnetic field.

The diameter of the light spot can be diminished by magnetic coils surrounding the tube, through which an electric current flows. The intensity of the current (am-

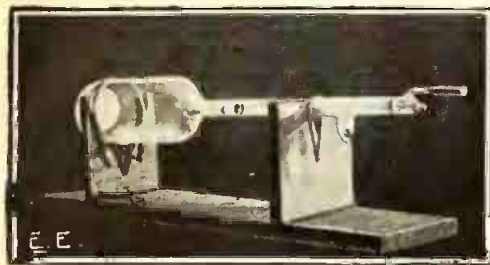

Typical Form of Braun-Tube.

called Geissler tubes. An electric current passing through this tube will follow a path from the anode to the cathode, showing the well-known luminous effect. But if the gas is more and more rarefied this usual light effect disappears and the cathodic rays begin to develop themselves. They do not follow the path (if we may so term it) of the current, but are emitted from the cathode normally to its surface straight into the gas. The anode may be placed anywhere in the tube, one method being shown in Fig. 1. These rays impinge on the glass wall and produce an intense fluorescent light, which is usually green in color.

If the frequency of the charges varies at the rate of, say 100, the oscillations of the light point on a phosphorescent screen will also be 100; and if the frequency goes up to a thousand or a hundred thousand, the cathodic ray will always follow and never lag.

The effect of magnetic forces on this ray is the same as that on a current; the ray follows the magnetic force and is deflected in a direction perpendicular to such a force. Suppose you have a magnet coil, as Fig. 3, and pass an alternating current through it. If a cathodic ray lies in the field of the magnet it will be set in oscillation, according to the time period of the current.

The Braun-tube (Fig. 4) depends upon these properties, and can now be explained

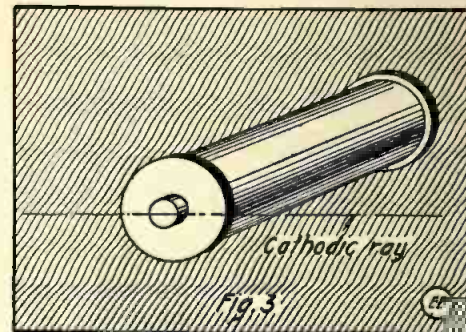

Fig. 3. Cathodic Rays Are Acted Upon by Magnets.

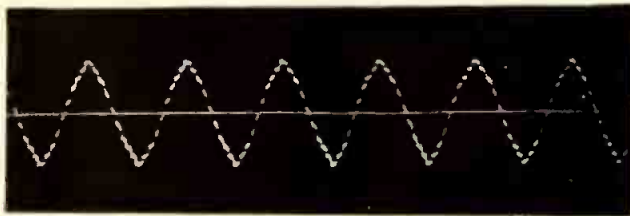

Fig. 6. Braun-Tube Oscillogram of 50 Cycle A. C. With Higher Harmonics.

pere-turns) and the best situation of the coil is to be found out only by experiment. The smaller the spot is the brighter it becomes. While the sensitiveness is diminished by this operation, it is not to any disturbing degree.

A static machine of 20 or more discs may be used as a source of high-tension electric current for operating the Braun tube. Smaller machines, of course, can be used, but the intensity of the spot will not be so great. The best source of current would be a battery of some thousand accumulators, which may be of small size. L. Chaffee used the large battery of Professor Trowbridge, which developed in

in a few words. It should be called a cathodic ray tube, which is the term by which I introduced it into the scientific world, but as it was later called the Brauntube I shall use this name for the sake of brevity.

Referring to Fig. 4, C is the cathode electrode, A is the anode and B is a small aperture made in a glass or metal diaphragm. As these materials do not allow cathodic rays to pass through, only a small stream of them pass through the opening, thus to create a "light image" on the fluorescent screen D. The tube is

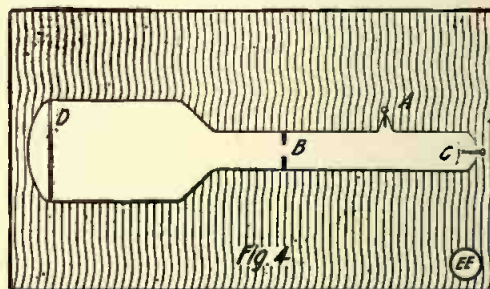

Fig. 4. Section of Braun-Tube.

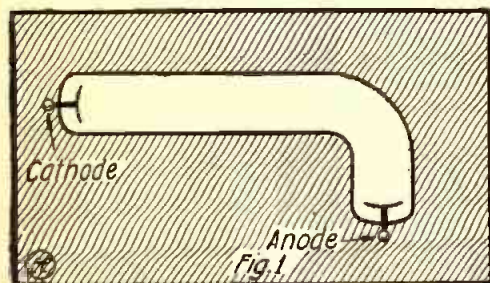

Fig. 1. Simple Cathode Ray Tube.

The cathode rays are streams of negatively charged particles (the electrons) flying through the vacuum with terrific velocity, this being between one-tenth to one-half and more of the velocity of the light (186,000 miles per second). These rays are practically without any inertia and represent electric currents in conductors; they are "flexible" in every direction. If you pass a cathodic ray between two metal plates (Fig 2), one of which may be charged positively and the other negatively, the path of the cathode ray is changed in the electric field of the small condenser

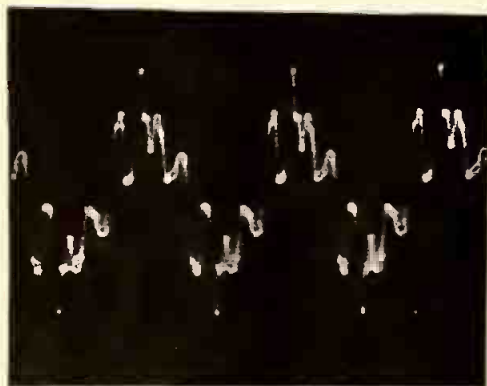

Fig. 7. Higher Harmonics of Fig. 6, Enlarged. N = 1,500.

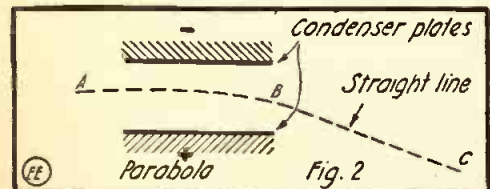

Fig. 2 Showing Deflection of Cathode Ray.

into the form of a parabola AB. After leaving this field it continues its way as a straight line BC. If the charge of the con-

evacuated to a high degree, and only by experiment can it be ascertained what the best degree of evacuation is. It can be estimated, however, by employing a spark gap placed parallel to the electrodes of the tube; a 2, 4 or 8 mm. spark length will be found the best as a rule. The brightness of the fluorescent spot depends upon the degree of the evacuation, as the higher this is the brighter will be the light, but the less will be the sensitiveness of the deflection

most cases 20,000 volts. Induction coils should not be used, as the deflection depends upon the voltage of the current.

By using a Wehnelt cathode (i. e., an electrode covered with a spot of calcium oxide and heated by an electric current) a voltage of 1,600, 1,000 and even 600 volts is

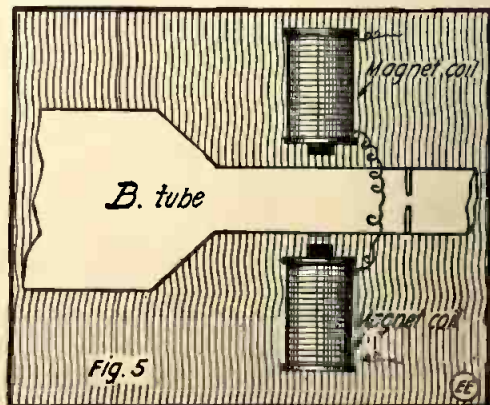

Fig. 5. Magnetic Control for Braun-Tube Ray, sufficient for producing cathodic rays, although they are not very sensitive.

*This article was prepared exclusively for *The Electrical Experimenter*.

The great advantage of the Braun tube is that it will record a pulsating electric

manner as to catch the phosphorescent spot on the screen we can "see" the vibrations, literally speaking. If a moving film is passed near the mirror it will photograph the curve. The light of the spot in good tubes is strong enough to permit of taking photographs of it up to frequencies of about 1,200 per second.

Professor Zenneck has used the tube in many of his researches, and I herewith give several illustration of his work.**

Fig. 6 represents the vibration form from the current of a machine connected in a circuit with ohmic resistance only; the frequency (N) is 50. The fine points demonstrate higher harmonics (N being about 1,500). These latter are clearer in Fig. 7. There is a condenser of 10 Microfarads in this circuit.

Fig. 8 is taken with a current $N = 1,080$.

Figs. 9 and 10 are images of damped, coupled circuits ($N = 250$); Fig. 9 for loose coupling; Fig. 10 for close coupling.

The greater the frequency the greater the difficulty encountered in taking a momentary or instantaneous photograph. But if we can devise an arrangement which will cause the "light spot" to pursue exactly the same closed curve on the screen; for instance 100,000 times or more, we shall then be able to take a photograph of this standing figure. In this manner, the details of

"light spot" now describes an ellipse (the so-called Lissajou's "curve") on the screen. OA measures in a relative way the field resulting from the coil pair 1, 1, and OB that of the coils 2, 2. The phase difference is expressed by the situation of the axis of the ellipse. For the phase difference of 0°

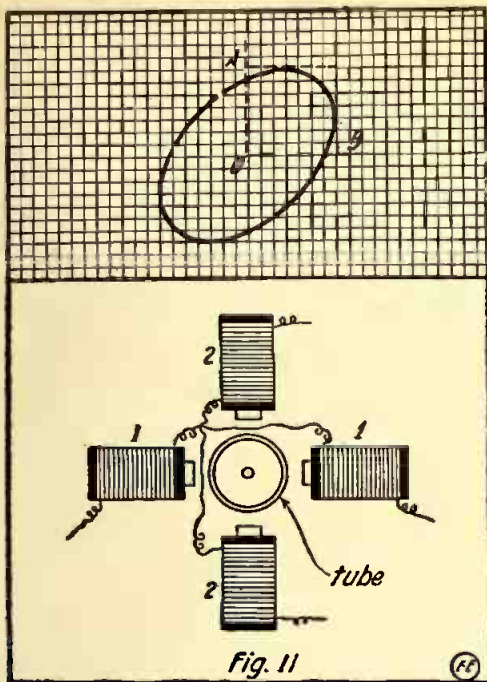

Fig. 11. Magnets Placed About Tube and Connected to Give a Phase Difference. The Curve Resultant is Seen Above.

current of frequencies which are impossible of registration in any other way. The difference between a galvanometer and a Braun tube may be explained by an illustration. It is a well-known law that the electro-motive force induced in a conductor which is moved in a magnetic field is proportional to the velocity. This cannot be demonstrated by a galvanometer, the deflection of which does not depend upon the instantaneous value of the current, but on the movement of a swinging element of definite inertia. The deflection of the cathodic ray depends only on the instantaneous value of the current or voltage. Consider a coil A connected with the indicator coil of the tube acting upon the rays. Give the coil A a small movement in a magnetic field. If the speed is slow the deflection will be small; as the speed is increased the deflection will be increased. The absence of inertia of the cathode ray enables one to gauge the static field by this tube then. This is extremely difficult to do with any other apparatus which we have at present.

I shall give several examples for the use of the Braun-tube:

1. *The Form of Vibration.*—There may be one, but better two "indicator coils;" one on the left, the other on the right side of the tube, as shown in Fig. 5. Let us suppose for the sake of simplicity that an alternating current is passed through the

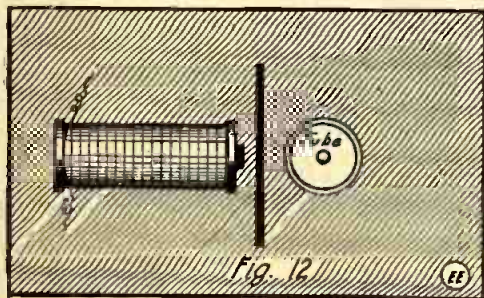

Fig. 12. Experiment to Demonstrate Screening Effect of Iron Plate Before Magnet.

coils. The light spot assumes the form of a straight line, the length of which measures the double amplitude of the current. If a revolving mirror is placed in such a

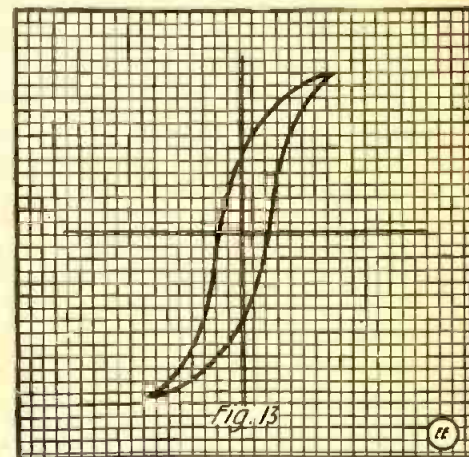

Fig. 13. Hysteresis Curve Obtained by Placing Iron in Coil.

and 180° , you observe a straight line; for 90° difference, an ellipse with axes vertical and horizontal. In any other case the ellipse would be in a different situation.

If the time period of the two interfering currents is not the same, but in the ratio 1 : 2, 2 : 3, etc., you observe other well-known curves.

We may now consider some lecture experiments. For simplicity we take only one coil (Fig. 12). We place a number of fine iron or nickel wires in the coil and the deflection of the spot increases. We bring a thin plate of the same materials in front of the coil and the deflection decreases; we now have a screening effect.

We next use crossed coils (Fig. 11). All the coils may be connected in series, but the two coils 1, 1 are connected in this manner so that their magnetic fields at their meeting place in the cathodic rays are opposed to each other. So we see on the screen a horizontal line measuring the (double) amplitude of the alternating magnetic field of the coils 2, 2. If we introduce into one or two of the coils a quantity of fine iron wire, then we observe a curve like that at Fig. 13. It is the hysteresis curve of the material; of course, not the true form of it, as the iron core is not a closed one and thus the curve is disturbed by the reaction of the free poles. However, it is clearly demonstrated by the curve that the magnetization of the iron, nickel, etc., depends upon the earlier magnetic states (the magnetic history of the piece).

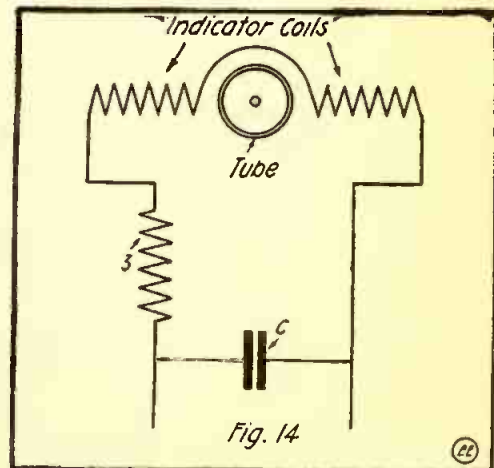

Fig. 14. Hook-Up of Tube for Showing Impedance Effect.

Suppose we use one or two indicator coils and a coil 3 (Fig. 14), having a great num-

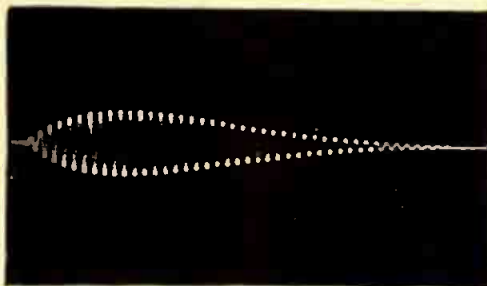

Fig. 9. Loose-coupled, Damped Discharge.

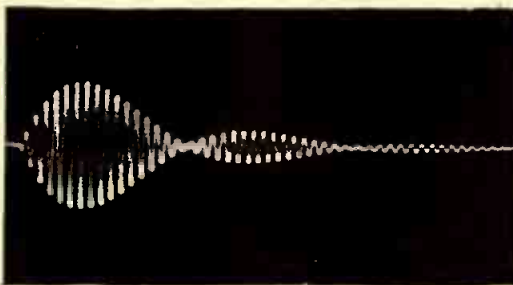

Fig. 10. Close-coupled, Damped Discharge.

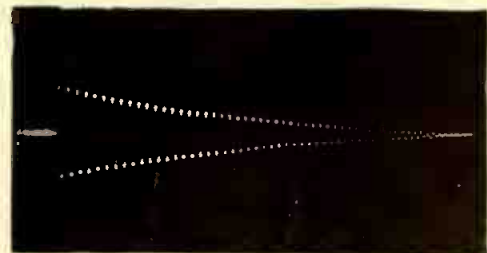

Fig. 8. Oscillogram of 1,000 Cycle Damped Current.

which cannot be explained here, as it will require too much space, photographs have been taken of oscillating currents at frequencies up to 1,000,000 or 1,500,000 cycles per second.

Let us suppose we have two sets of coils, 1, 1 and 2, 2 (Fig. 11), of which the axes are crossed at right angles. An alternating current of the same time period is sent through each pair of coils, but the current in the pair 1, 1 may have another phase than that in the second pair 2, 2. The

**For a complete account of the apparatus used for taking photographs by means of the Braun-tube, see J. Zenneck *Physikalische Zeitschrift*, No. 14, of 1913, page 226.

Baron Münchhausen's New Scientific Adventures

By Hugo Gernsback

The Planets at Close Range

WHAT is modesty? From childhood up I have been taught that this quality was more or less of a virtue, but developments of late cause me to believe that it is hypocrisy, plain and simple. I have found since, that modesty is something in us which we wish to make other people believe and which they realize perfectly is not so, or perhaps trying to make the other fellow believe something that you know isn't so. All of which might have a passing interest for you and then again it might not; probably the latter is quite true. Perhaps the above may have a certain bearing on this story and on the other hand it might not; probably that is quite true also.

I have no fault to find with the Martians, and I believe implicitly what Münchhausen has been telling us about the utter frankness of the Martians and their habits. Only it doesn't work on earth, or at least it doesn't work in Yanktown. As will be remembered, Münchhausen told us a little while ago that the Martians live in transparent houses, for reasons best known to themselves. As will also be remembered, he told us that anything that is worth doing—on Mars—is worth doing with everyone looking on. He told us that non-transparent rooms make for nothing but laziness and vice; also that when your actions are open to the entire world you are more apt to lead an upright life than otherwise. We were told that for that reason no false make-believe life was lived on Mars as is the case on earth.

course, that everyone else is apt to take a bath once in a while for strictly personal reasons, the only difference being that the frequency varies with some individuals according to taste and according to the available water as well as soap supply. I know that you take a bath and you know that I take a bath; certainly there is no secret about that. Nobody should find fault with such universal custom. But when I tried it the other day, leaving my bathroom window wide open, it somehow didn't work out according to the Martian recipe, at least Officer Mulligan, on the beat, who I believe had not read about the Martians' habits, didn't approve of my custom and very promptly arrested me when a big crowd collected in front of my bathroom, which happens to be on the ground floor. I have since given up trying to convert antiquated humans living on an uncivilized globe, to Martian standards of civilization. Perhaps in a hundred thousand years from now humanity will not feel so peevish about it, but until that date I shall believe in the proverb, "When in Rome bathe as the Romans bathe."

* * *

Promptly, as usual, that evening Münchhausen "called." On the minute at 11 p.m. the familiar whining, screeching sound reverberated in my 'phones, and immediately following the Baron's sepulchral rasping voice was heard once more.

graphone wire on my radiomatic was full to capacity before I stopped speaking. If my memory serves me right, I believe I had been telling you about the Martian elevated cities—and how the Martians do away with their choking dust filling up the atmosphere near the ground. I told you how the elevated Martian cities had perforated, metallic streets so that the fine dust would filter through the perforations thence to fall down to the ground. Possibly it occurred to you that in a few hundred years this dust settling on the ground below would rise high enough to fill up the 500 feet of intervening space between the ground and the elevated streets. If no means were taken to do away with such accumulating dust and sand this, of course, would be the result, but nothing of the sort happens, for Martian ingenuity naturally precludes any such occurrence. But how is the sand and dust done away with? It is a very simple matter indeed. Mars, as we know, is a very ancient world, which has cooled for centuries back. There are no more live volcanoes on Mars, for the very simple reason that the inside of the planet has cooled long ago, the same as is the case on your Moon to-day. Take the earth, which is a much younger heavenly body than Mars. On earth, as yet, the interior is in a molten state, proven by the fact that volcanoes still exist, as well as hot springs. Hot gases must naturally abound for if this were not the case there would be no pressure to force the molten lava through the

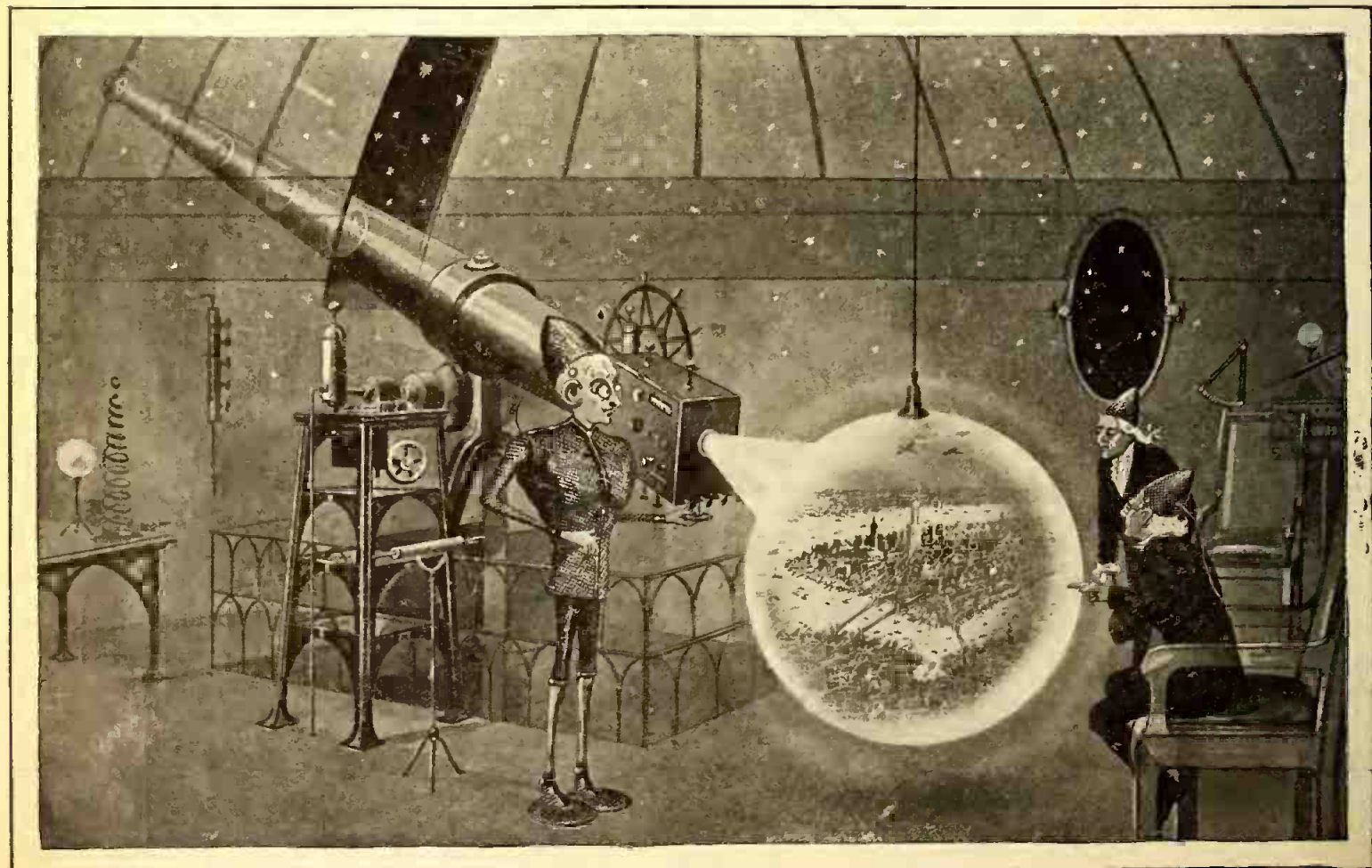

... Again the knobs were manipulated, and we now saw a most marvelous view of the City of New York, as if viewed by an aviator a few thousand feet above the earth.

I tried the Martian recipe the other day, and I must confess here that it was a dismal failure. Now everyone knows, of

"Good evening, my dear boy; mighty sorry I had to cut myself so short last night but, at that, I believe that the tele-

craters of the terrestrial volcanoes. But a molten mass as well as hot gases take up room. Suppose the interior of the world

would cool to-day; immense hollows or voids would naturally be created inside of the earth. This is precisely the case of Mars, which has now immense hollows and voids, and these are used for many different purposes by the Martians in their conquest of their dying world, as I shall show later.

"For one thing, every few miles beneath all Martian cities immense funnel-shaped holes are drilled till one of the voids is reached. The openings of these holes are constantly kept clear by the Martian engineers. How simple, then, is the thought of pushing the surplus desert dust and sand into these holes to do away with the sand nuisance. Very ingenious means are used in thus getting rid of the dust, and after every sandstorm, which are more or less frequent, the surplus sand and dust rolling on from the open deserts is forced into these openings as fast as it develops. Of course, it is impossible to thus get rid of all of the sand, but it helps in a certain degree to make life bearable on the planet.

"You will remember in my report of last night that on that evening Flitternix and I were on the Planet Ruler's mansion on top of the building looking down on the vast Martian capital that lay below us. We were watching in amazement the gravitationless fliers, which are used by the Martians almost exclusively for their transportation. I have told you previously that these fliers are flat, pancake-like, metallic bodies with three masts spaced equally distant from the center. We saw thousands of these gliding noiselessly through the thin Martian air, their intense yellow propelling light shafts plying all over the sky and over the ground. It is indeed an inspiring sight to see thousands of these fliers in the air all the time, and the spectacle becomes even more amazing when night comes. The yellow emanation rays are highly luminous, and for that reason no other searchlight is required. As long as I have been on Mars I have never witnessed a collision, although these astonishing vehicles fly so close to each other that one sometimes thinks they must collide. Each Martian building on one of its sides has a metallic landing platform extending at right angles from the building. There the fliers land to deposit passengers or freight.

"We were watching this amazing spectacle; it was in the early evening and the sun had just set. Being accustomed to twilight we naturally thought it would stay light for some time to come, but we were surprised that no sooner had the sun disappeared behind the western horizon than the landscape became pitch black. I was about to comment upon this unusual phenomenon when Flitternix forestalled my questions, launching into his usual astronomical reflections.

"My dear Baron," said he, "no doubt you have been surprised that there is no twilight on Mars, but the reason, of course, is very simple. The earth to which you are accustomed has a very dense atmosphere. After the sun has sunk below the horizon its rays still strike the atmosphere above you, although you cannot see the sun itself. Naturally, it does not become dark immediately for the reason that the light is diffused in the air above you up to about 30 miles above the surface of the earth. In other words, the sun on earth acts exactly like a searchlight which is hidden from

your sight while its light shaft plies above your head. You can see the light perfectly over head, and the sun's rays act in a similar manner on earth.

"On Mars, however, the atmosphere is

WHEN the famous Italian astronomer Schiaparelli in 1877 first glimpsed the Martian "canals" through his modest telescope, the world at large believed his observations to be a mere optical illusion. Time and progress, however, have so improved our telescopes, such as, for instance, the one at the Flagstaff Observatory, that on account of the immense magnifying power, the "canals" stand forth sharp and unmistakable. How far can science go in increasing telescopic magnification? Will we ever see the Martians themselves through the telescope? Read this instalment and see.

very thin and only reaches a comparatively few miles above the surface of the planet. Therefore but little light is diffused in an attenuated atmosphere, as is well known to you, and for this reason no twilight can exist on Mars; this you have just witnessed. As previously experienced during our stay on the moon, where there is no air of any consequence, everything must be dead black or white, there cannot be any grays in the transition from light to dark. On Mars, of course, such extremes do not exist for the reason that there is still some atmosphere to diffuse the light.

"While Flitternix was still talking we saw the marvelous sight of the city below us being illuminated at the precise moment when the sun had sunk out of sight.

"Nearly every structure and building on Mars is of the same height. On top of their cone-shaped roofs several immense, transparent spheres are spaced 20 to 25 feet apart. These balls are usually arranged in a circle or in an equilateral triangle. No sooner has it become dark on Mars than these transparent balls emit a dazzling rose-white light. This light does not emanate from these globes in form of a shaft, as we are accustomed to from searchlight illumination. Quite the contrary; the light spreads out in all directions for a distance of over 500 feet. The strange fact is that the light is as strong at this distance as it is in the immediate vicinity of the spheres. As a matter of fact, it is strongest about 25 feet from the balls themselves. Inasmuch as every building and every elevated structure gives forth this spreading light every object within 500 feet of the light balls is illuminated almost as strongly as in daytime with the sun shining. This creates the curious result that when walking in a Martian street at nighttime daylight is simulated in a perfect manner and it is hard to realize that it is not, indeed, sunlight that is pouring down upon you. Not only do these transparent light balls give out light rays, but the rays also emanate heat prodigiously. This is quite necessary. I have spoken before of the fact that the Martian atmosphere is very thin and attenuated. Naturally such a thin blanket of air cannot retain the solar heat during the night, and for that reason the nights on Mars are extremely cold. This is true of the temperate as well as of the other zones. For this reason the light rays of which I spoke before have been made to radiate heat as well, otherwise it would be too cold to walk on the streets after nightfall. As it is, the temperature is but slightly below that which exists at noon time. It will, of course, be plain to you that as soon as the sun rises in the morning the light balls are switched off, for

then there is no further use for them.

"You might think that it would be an enormous undertaking to light and heat vast cities by such artificial means, but the cunning Martian wherever possible lets

Nature do all of his hard work. I have already shown to you how the Martians moved the water in their canals and waterways by means of the all-dominant sun, and if our luminary can perform useful work during the daytime why not use it at night? I have mentioned before how the Martians harnessed the sun's energy, storing up enough power to use the surplus after sunset. Thus we find the curious phenomenon on Mars that the intelli-

gent beings inhabiting this planet have harnessed enough energy from the sun during the daytime that when released it furnishes them with light and heat during the night. The sun's energy during the daytime is converted into electricity, as I have already shown, and is then stored for further use. Consequently the night illumination and heat is derived primarily from the sun and costs the Martians nothing. When you consider how crudely you humans use your energy it must dawn upon you that you are still very young children. At that the inhabitants of the earth are doing precisely what the Martians are doing except doing it in a very bad way. You are already deriving 100 per cent. of your light, heat and power from the sun *indirectly*. The coal which you are mining this minute derives its original energy from the sun. Millions of years ago great forests—which were directly a product of the sun—sunk into the earth, thereby carbonizing the wood. This wood you are burning as coal to-day. In other words, you are using sun-power, stored millions of years ago. Even your water-falls from which you derive your power are directly dependent upon the sun. Without the sun to suck up the water from the seas into cloud form, your water-falls would run dry within one week. The Martians, who have long ago exhausted such means of utilizing the sun-power, are now using the sun-power supplied by the sun yesterday. You on earth to-day are using sun-power stored millions of years ago. After your coal supply gives out and after your water supply is not as abundant as it is at present you will revert to exactly the same means as do the Martians on their dying planet to-day.

"After dinner the Planet Ruler took us to a vast circular room high up in the mansion, which we presumed to be his study. The thing that struck us most forcibly at once was an enormous glass-like transparent rod which broke through one of the transparent walls of the room. This rod probably measured two or three feet in diameter, and as far as we could see it was about 15 feet in length. We afterwards found out that it extended 75 feet beyond the building, pointing toward the sky. The thought immediately forced itself upon us that it was a form of telescope, which indeed it was. It was arranged in telescope fashion and by means of machinery located outside of the room, the far end could be made to point to any object in space. As the mansion of the Planet Ruler revolves around its axis, as I have already mentioned to you previously, the telescope may thus be pointed at

(Continued on page 741.)

Marvels of Modern Physics

By Rogers D. Rusk

Assistant Instructor in Physics, Ohio Wesleyan University

Invisible Radiations.

IN very recent years many forms of radiation have been discovered which do not affect the eye, and hence are invisible. Already the benefits which have resulted to mankind have been of infinite value, even though this branch of physics is only in the infancy of its development.

Radiations may be roughly divided into

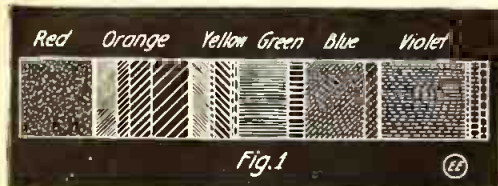

Fig. 1. How the Colors of the Visible Spectrum Range Themselves.

two general classes; (1) those which consist of material particles traveling at high rates of speed, and (2) those which consist, not of material particles but of vibrations in the ether similar in nature to ordinary light waves. The first of these classes we will leave until we have considered the various kinds of ether waves.

Consider a beam of sunlight passed through a prism. The different lengths of light are spread out in a broad band of colors. The same thing happens when sunlight is reflected and refracted by raindrops, and we see the rainbow. When the light waves strike the prism at an angle they are slowed down in speed and also bent a little from their original path. The violet waves being the shortest, are bent the most; and the red waves, being longest, are bent least of all. The colors now range themselves, as shown in

Fig. 1, in the order of their wave lengths. The perfect blending of the colors thus demonstrates clearly that the waves vary gradually in length, from the longest to the shortest, but it must not be thought that they suddenly cease to exist at the upper edge of the violet or the lower edge of the

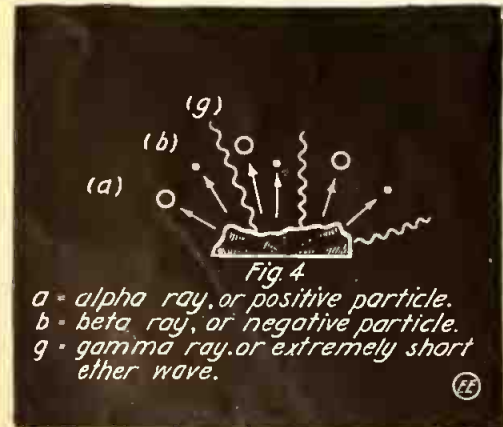

Fig. 4. How Invisible Radiations Occur About Radio-Active Substances, Such as Uranium.

red. It is quite true our powers of visual perception cease very suddenly at those points, but it is easily proved that waves of other lengths exist beyond them. Those

of us who are imaginative often wonder what strange colors might be beyond the violet and the red, if only they were visible.

Red light has been measured as having a wave length of 1/37,000 of an inch, and violet a wave length of 1/70,000 of an inch, while the orange, yellow, green and blue are intermediate. As we know that light travels at the velocity of 186,000 miles per second, we can easily calculate the number of vibrations made in a second by each kind of wave. (See Fig. 5.) A single wave, then, travels in a second about 10,000,000,000 inches, and 10,000,000,000 times 37,000 equals 370,000,000,000,000, or a red light wave vibrates approximately 400 million-million times per second. In the case of violet light the vibration rate is about 700 million-million times per second. The wave lengths cited below will give a clearer idea of this factor.

COMPARISON OF WAVE-LENGTHS.

| Wave. | Length in cm. |
|---------------------------|---------------|
| Hertzian wave.* | 1,500,000. |
| Hertzian wave.† | 0.5 |
| Heat waves (longest)..... | 0.13 |
| Red light | 0.000077 |
| Violet light | 0.000036 |
| Ultra violet.‡ | 0.000010 |
| X-rays | 0.00000001 |
| Gamma rays | 0.000000001 |

* Longest yet generated.
† Shortest yet generated.
‡ Shortest in solar spectrum.

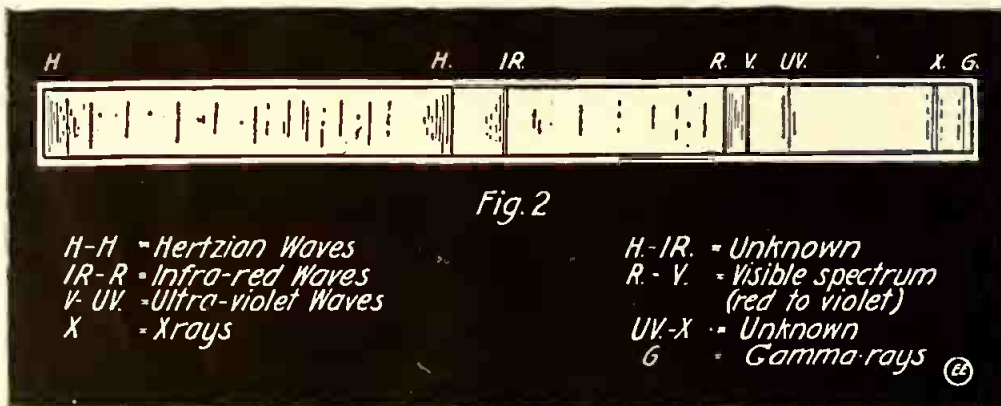

H-H - Hertzian Waves
IR-R - Infra-red Waves
V-UV - Ultra-violet Waves
X - X-rays
H-IR. - Unknown
R - V. - Visible spectrum (red to violet)
UV-X - Unknown
G - Gamma-rays

Fig. 2. Extended or Invisible Spectrum Shown Diagrammatically.

The visible spectrum can be divided into three general divisions—the red and orange, or heat portion; the yellow and green, or luminous portion; and the blue and violet, or chemical portion, sometimes called the actinic.

Langley traced the longer rays beyond the visible eye (known as the infra-red) for 10 octaves below the visible spectrum, largely by means of an instrument called the bolometer. An octave in light, it may be stated, is similar to an octave in music; that is, it is the interval between two lengths of waves, one of which is twice the other. The visible spectrum, then, is approximately one octave. Langley's bolometer was merely a sensitive Wheatstone bridge with one arm made of blackened platinum. Infra-red rays falling on the blackened arm would be absorbed, and the resulting change of resistance due to a rise in temperature would be apparent from the deflection of the galvanometer. Thus the change in temperature could be measured.

The ultra-violet rays, on account of their chemical or actinic properties, have been easily traced by using the common photographic plate for about two octaves above the violet. Waves shorter than this are absorbed by the air.

It must not be thought that the three classes of waves in the visible spectrum

were so named because they possessed one property alone. Any of the waves possesses all three properties to a greater or less degree. The classification only serves to emphasize the more prominent characteristic of each. The close relation of the various waves can be seen by taking a cannon ball and heating it. At first very

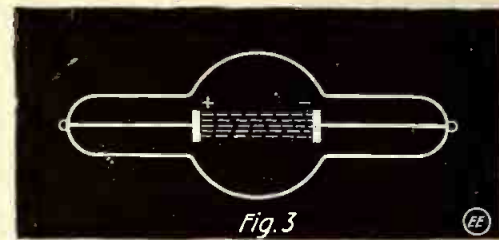

Fig. 3. Simple Tube for Studying Electric Discharges in Vacua.

long waves are given off, and as the iron becomes hotter the waves become shorter. Finally red light is emitted, and then the cannon ball passes through the stages from red to white heat. That heat waves are only long, invisible light waves is readily seen.

The great scientist Hertz, in addition, proved that electric waves produced by the spark discharge of an induction coil are identical in nature with light waves, and are reflected, refracted and polarized according to the same laws as light waves. Hertz in his experiments used waves of eight or nine meters length. Since then, in wireless telegraphy and laboratory research, waves have been produced directly, varying in length from several thousand meters to only few millimeters. The

shortest, however, are many times longer than the longest visible wave.

Radio detectors are able to detect these long waves due to their heating and other manifestations.

These relations which we have noted lead us to the thought that a complete or extended spectrum can be diagrammed in the same manner as the visible spectrum, and

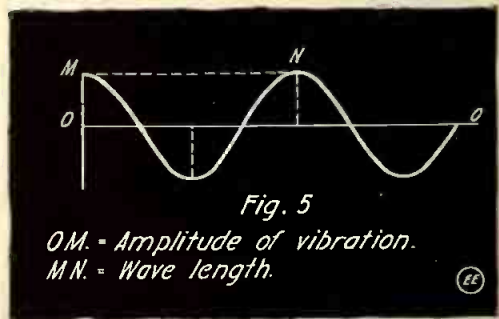

Fig. 5. Components of a Transverse Vibration or Wave.

in Fig. 2 we have the different waves arranged in the order of their length, from those of thousands of feet to those of only a few trillionths of an inch wave length. Such a comparison is valuable. More striking phenomena have been noted in the (Continued on page 736.)



The RADIO LEAGUE of AMERICA

HONORARY MEMBERS
CAPT. W.H.G. BULLARD, U.S.N. NIKOLA TESLA.
PROF. REGINALD FESSENDEN. DR. LEE DE FOREST.



Manager, H. Gernsback

How to Organize and Conduct a Radio Club

(Concluded)

To Effect an Organization.
CONSIDERING that a regular club is to be organized with fifteen to twenty or more charter members, the following parliamentary rules are useful:

After a call to order has been given for a stated meeting or to effect a certain organization, any person interested, or appointed by common consent, may call the meeting to order and state the reason for the assemblage, asking any of those assembled to nominate a chairman. He puts motions or nominations to vote until the majority agree upon one man who is declared elected. He takes the chair and proceeds to conduct an election of secretary and the other necessary officers required for the time being, until a permanent organization can be effected; these officers can be made permanent if the assemblage so agrees. The organization also can be made permanent by a vote. The chairman appoints a committee to draft a constitution, by-laws and rules of order, which should contain at least these articles:

1. The name and object of the society.
 2. Qualifications of membership.
 3. Officers, how elected (i. e., by oral or written vote) and duties.
 4. Meetings of the society.
 5. How to amend the constitution.
- At a second meeting the constitution should be adopted and signed

by all who wish to become members; by-laws can be adopted and a committee appointed to nominate permanent officers to be elected at this or a future meeting.

Duties of the Several Officers.

The chairman or president enforces the rules adopted; calls the house to order; announces its business; sustains order; explains and decides questions of order, with the provision of reversal being given the house; appoints all committees not otherwise provided for; recognizes speakers; submits motions; puts to vote all questions regularly moved; announces results; signs official documents. He is given precedence in speaking on questions of order and decides tie votes.

The vice-president acts for the president in his absence. In his absence the secretary acts.

The secretary records the proceedings of the organization; writes all letters; calls the roll for absentees or votes; reads minutes of previous meeting; reads all papers and documents to the organization; keeps committees informed of their work; signs all records and is responsible for all papers belonging to the organization. The secretary can act in the absence of both president and vice-president to appoint a temporary chairman.

The corresponding secretary has charge of all correspondence received or sent out by the organization.

Motions.

A motion can be made by any member who properly obtains the audience of the house, but after a motion has been seconded it cannot be recalled except by the permission of the house. No motion can be made while a member is speaking nor while another motion is before the house. Motions must be written if so desired by any member or vote of the house.

General Order of Motions.

1. To appoint a time for adjournment, B.
2. To adjourn for unlimited recess, A E F.
3. Orders of the day, A E H N.
4. To lay upon the table, A E G.
5. Call for the previous question, A E M.
6. To postpone action to a fixed time, C.
7. To refer to committee, D.
8. To amend or to reconsider, I K.
9. To suppress or postpone indefinitely, D E.

Rules Governing Motions.

- A. Not debatable.
- B. Not debatable while another question is before the house.
- C. Limited debate allowable on propriety of postponement.
- D. Concerns the main question.
- E. Only amendment permitted is a motion to adjourn.
- F. Cannot be reconsidered.
- G. If voted for affirmatively, cannot be reconsidered.
- H. In order even when another has the floor.
- I. Precedes all except adjournment, but cannot be put by any person voting with the minority.
- K. A

This shows what a "live" radio organization can accomplish. If the interest of the members is properly sustained by capable management, it is an easy matter to obtain a first-class set of instruments suited to the requirements of any particular club, depending upon the number of members enrolled.

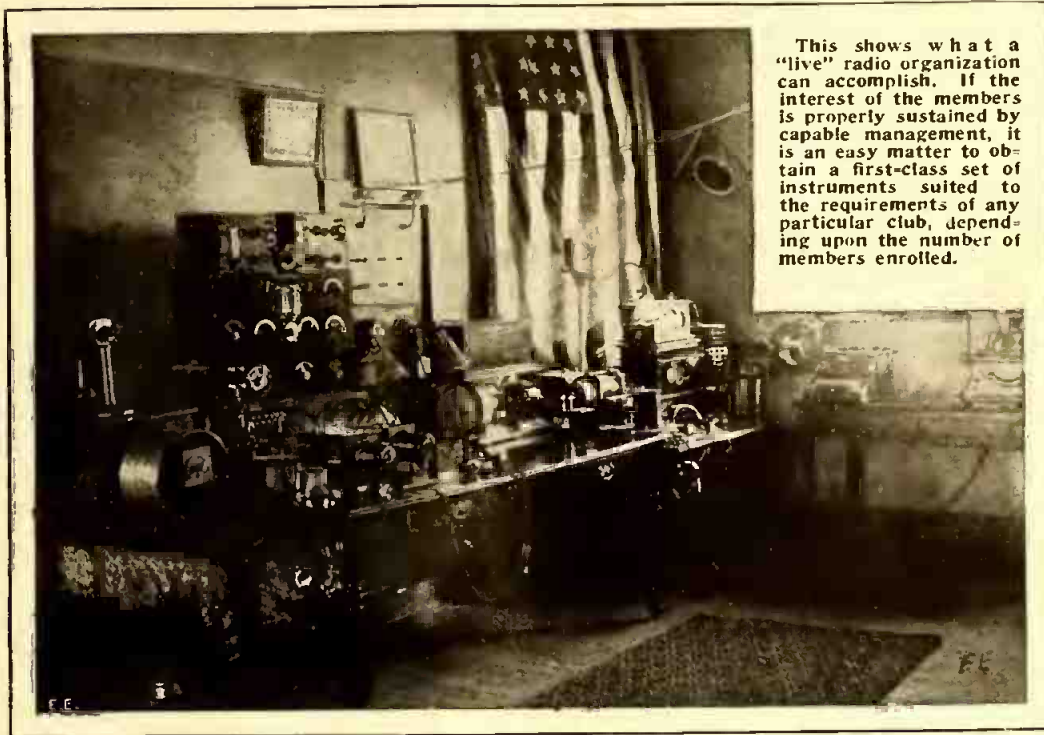

Extraordinarily fine and complete wireless station owned by the Colorado Wireless Association, of Denver, Colo. Workshop and club room (here shown) obtained through courtesy of local Y. M. C. A. Transmitting equipment includes two 1-Kw. rotary quenched spark sets giving a night sending range of 1,000 miles (maximum 1,500 miles). Receiving apparatus incorporates ultra-audion and two-step amplifiers with tuning inductances for waves up to 20,000 meters. They hear practically everything in the ether between Germany and Honolulu, Alaska and Panama. The station's call is KIX (limited commercial government license). Secretary's address, Lawrence P. Hough, 1060 Josephine St., Denver, Colo.

The treasurer handles all moneys of the organization, receiving and disbursing as ordered by vote, and accounts for it to the society.

Length of Time Which Office is Held.

Officers should be elected to serve for six months, or at the longest for one year.

Membership.

Membership implies that a person has been regularly received according to the rules of the organization and has duly signed the constitution. A member must obtain the consent of the chairman before he can address the house; must speak only on the subject in hand, unless otherwise permitted; must give due respect to fellow members in his speech and promptly yield to the chairman's call to order. A majority of members constitutes a quorum, unless otherwise designated by the constitution.

motion to amend an amendment cannot be sustained. L. The chair is sustained when an appeal to the house results in a tie. M. Requires a two-thirds vote, unless special ruling is made. N. No second required.

A Question.

A question should be put first on the affirmative side, and then on the negative. If any doubt arises as to results, a division of the house may be had. A question can be lost in a tie unless the chairman casts the deciding vote affirmatively. After a question has been put, it is not debatable until after the affirmative is put, when anyone, not having spoken before, may speak before the negative is put. Several questions in one may be divided and taken separately. No one can vote on a question af-

(Continued on page 728.)

RADIO DEPARTMENT



Radio Range and Direction Now Found by Instruments

I NESTIMABLE in value has been the boon conferred upon man by the invention and development of wireless telegraphy, but its full value has never yet been attained, because of serious defects.

lighthouses or fog signaling stations. Also it should find considerable application in the military service for field and trench work as receiving apparatus thoroughly portable, requiring no antenna or ground

ceiving distress signals, as they would be able to locate their source at once.

The photograph herewith shows Frederick Kolster, of the Bureau of Standards, and his new radio direction and range-finding apparatus.

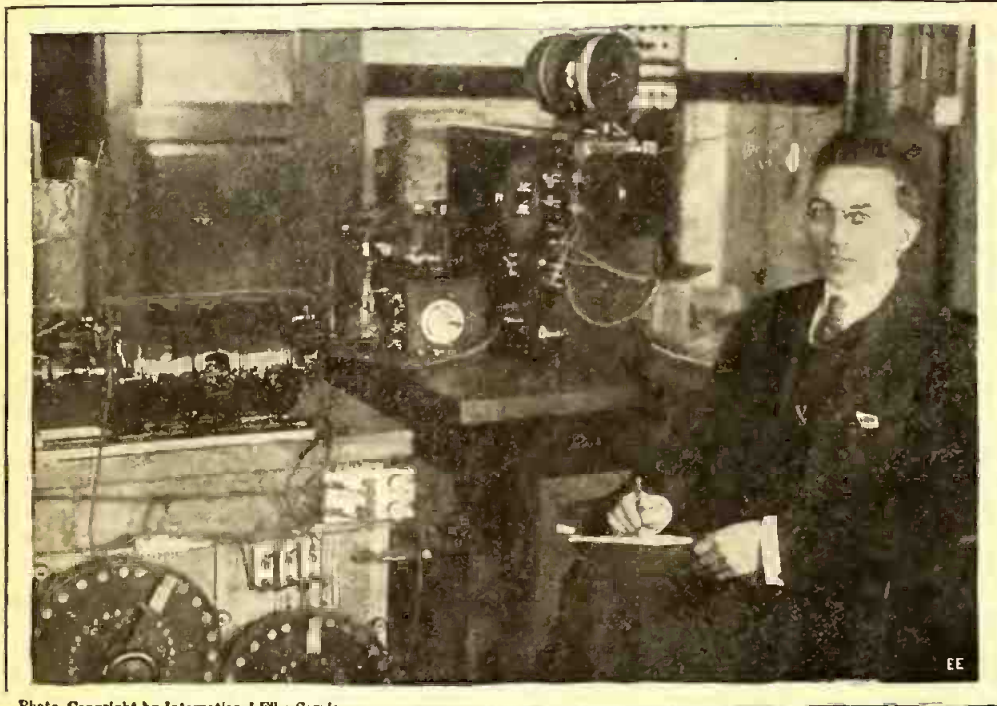

Photo Copyright by International Film Service.

Frederick Kolster, of the U. S. Bureau of Standards, Inventor of New Radio Range and Direction Finder and the Apparatus Used.

Only vaguely and entirely by guess could a trained wireless operator tell by the strength or weakness of the "spark" the distance between himself and the instrument transmitting the call to which he was listening.

It has been left for one of the United State radio experts—Frederick Kolster, of the Bureau of Standards—to develop a satisfactory radio device of simple design, capable of ascertaining not only the *range*, but also the *direction* from which the wireless message emanated.

It is said that the device has proven very satisfactory in a number of careful tests conducted by the Bureau of Standards. Messages have been received on one or another of three different sizes of instruments that have been built so far—from Philadelphia, Boston, Glace Bay, Newcastle (N. B.), New York, Norfolk, New Orleans, Panama, Key West, San Diego and Hanover, Germany. This new device, perfected by Mr. Kolster, also cuts down the atmospheric disturbance effect noticeable in practically all other radio telegraphic receptors. The direction-finding apparatus of this inventor's design is operated entirely indoors, having no antenna and no earth or outside connection. Such a device is much in demand by radio inspectors and agents of the commercial radio companies for the purpose of checking up ship locations, interfering stations and the distances between ships, also between ships and

as aforementioned, is of light weight and can be readily carried by one man. An-

TUFTS COLLEGE HAS NEW HIGH POWER RADIO STATION.

T HERE has recently been completed and set in operation at Tufts College, Medford, Mass., a high-power radio station, one of the best equipped in the United States. The great feature of the station is the immense skeleton steel, aerial mast, 304 feet high, which is embedded in solid concrete. The new tower may be seen for miles, its slender black framework, only 3 feet 6 inches square at the base, silhouetted against the sky. The tower is supported on four specially designed porcelain insulators which are firmly secured in 15 tons of reinforced concrete. The mast is constructed of 12-foot sections of structural steel and is held in position by 12 heavy crucible steel guy wires, one inch in diameter, secured at different heights and embedded at their bases in blocks of concrete. The tower is topped by a huge antenna which extends outward like a monster open umbrella. This shaft is said to be the highest in New England and the third highest in the United States.

A few feet from the tower stands the laboratory building, also built of concrete. To the casual observer this solid looking structure has little significance. The expert, however, will find carefully housed there, a complete outfit of high-power wire-

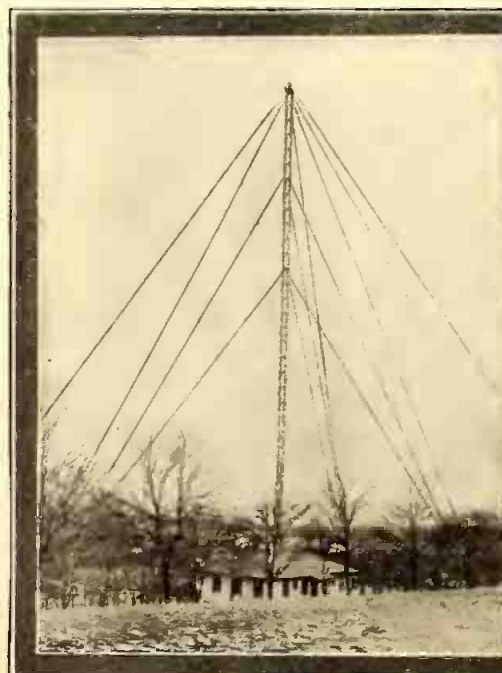

At Left: New 304-Foot Mast at Tufts. Below: Research Facilities Are Afforded in Abundance at the New Radio Laboratory.



other distinctly useful application for it would be in the Coast Guard service in re-

less apparatus, machinery and tools of the
(Continued on page 727.)

SENSITIVE MICRO-AMPERE WIRELESS RELAY.

It has been the dream of radio engineers for years that some day a relay would be perfected that would be sufficiently sensitive to respond to the extremely weak cur-

second. The oscillating frequency period can be changed by varying the distance of the levers F, F, and the coil. The ivory bone cup in which the mercury is kept can be moved either forward or backward by operating a small thumb screw located at the end of the con-

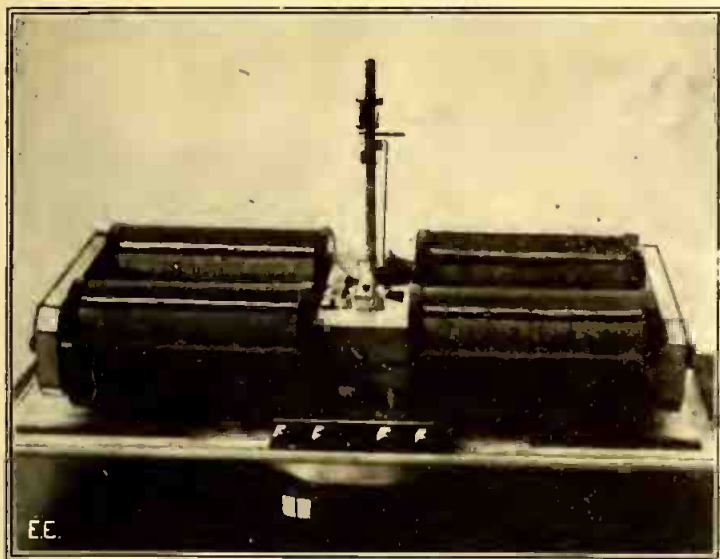

Fig. 1. A Wireless Relay That Operates on One-Millionth of an Ampere.

rents in circuits of wireless receiving sets, and we believe that the relay here described fills most of the requirements.

The apparatus as designed by Fritz Lowenstein, of New York, a well-known radio engineer, will operate on any receiving detector and is recognized as the most sensitive detecting device for electric current ever constructed for commercial use, as it will be deflected by a current of 1 micro-ampere (1 millionth of an ampere).

This super-sensitive relay is illustrated in Fig. 1, mounted complete on a stand, while Fig. 2 shows the details. The moving element C is wound with a coil of extremely fine wire and carries a contact D which makes connection with a small pool of mercury E when the armature is deflected. The moving part is supported on two-jewel bearings to eliminate friction and the connections to the moving coil consist of two very fine helical copper springs suspended at both ends. The upper spring is very clearly shown in Fig. 1. Two small discs F, F, are provided to regulate the swing of the coil, which is mounted between two pole pieces BB that are energized by the massive coils shown at A, A. The coils are so connected that the two pole pieces will have different polarities, thus forming a N. and S. pole. The current for these magnets is obtained from a 110 volt direct current supply and is led in through the wires G.

The operation of this wonderfully sensitive relay is as follows: The powerful electro-magnets are first excited and the moving coil is connected to the receiving outfit in place of the regular phones through terminals H, and a calling device, such as a bell, at the terminals I. When the coil C is excited by the feeble current produced by the detector, which, of course, is received by the other instruments from the radio transmitting station, it will turn, and its lever D will make contact with the pool of mercury E, thereby completing the circuit which causes the calling device to operate. The bell can be replaced with a tape register by which messages can be readily copied. This, of course, must be operated at a slow speed, as the moving coil has an oscillation period of .1 of a

second. The complete relay is supported on a table that can be rotated to offset any detrimental effects of the earth's magnetic field. A suitable cover with a glass top is placed over the instrument to prevent any dust settling on the delicate moving parts. This device is capable of withstanding shocks and will work even when slightly tilted, for it has been tested on moving vessels and the results were very satisfactory.

Although the relay is adopted for radio work, it will be very useful in a laboratory where it is necessary to detect very minute or feeble currents. By mounting

a sensitive microphone to make connection with the winding on the moving element this apparatus might then be used as a telephone relay, second only to the audion in sensitivity.

NEW WIRELESS CODE INSTRUCTOR.

A very simple wireless and telegraphic code instructor is that known as the "Mesco Codegraph." This outfit employs an enameled metallic plate, as perceived from the illustration, and on the face of which are arranged the dot and dash signals corresponding to the letters of the alphabet. The signal characters have the enamel left off them.

This little plate is connected up with a dry cell and ordinary buzzer, together with telegraph key. Ordinarily the Morse key shown is not used and the circuit is completed through the buzzer (or a sounder) by means of a steel pen, which is drawn across the bare metal dot and dash signals on the face of the metal plate.

These dots and dashes have the enamel scraped off, as explained, and thus a cir-

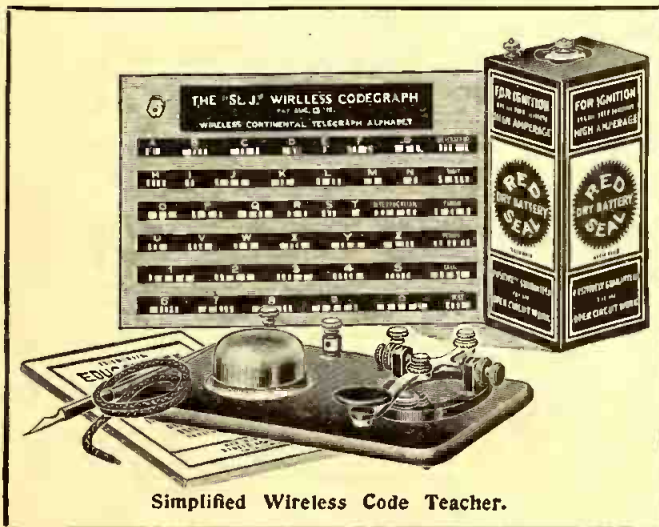

Simplified Wireless Code Teacher.

cuit is completed so as to give the proper sequence of signal characters. It is possible, of course, to thus learn the code without a teacher, and the speed may be

varied as required, according to how fast the pen is drawn across the plate.

This neat little outfit should find a wide field of usefulness among the younger radio students who do not care to invest in a high priced instrument for the purpose.

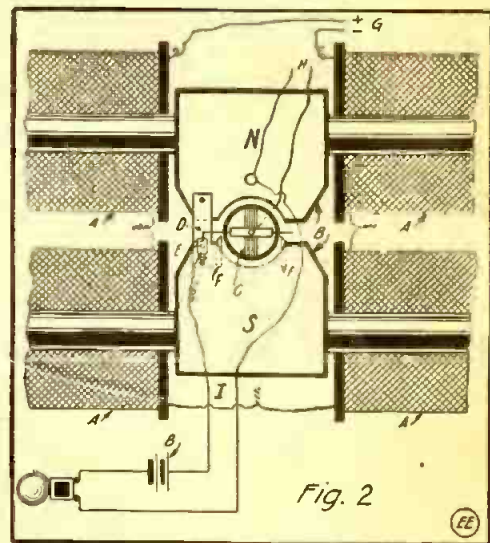

Fig. 2. Details of "Micro-ampere" Relay Moving Element

PUPIN'S NEW NON-INTERFERENCE ANTENNA.

After giving an interesting discussion on the formation of electro-magnetic waves in the ether, with special regard to their adaptation in wireless telegraphy, Prof. M. I. Pupin, the well-known electrical engineer, discusses briefly the theory on which his new non-interference radio device operates, in *Science*.

In the elucidation of his theory Prof. Pupin goes on to say: "The eye sees a very narrow strip of wave frequencies which are sent from a radiating body; the ear hears but a very narrow strip of wave frequencies which vibrating bodies can send out. Physiological optics and physiological acoustics deal with these remarkable facts. Now, the reason why the eye is blind and the ear is deaf to an enormous range of frequencies is certainly not due to anything like ordinary selectivity produced by tuning.

"Fifteen years ago I published several investigations which deal with electrical motion in sectional wave conductors. One of these resulted in the now well-known loaded telephone line. I regret that the technical importance of this invention, by attracting too much attention, has overshadowed completely the full meaning of the general mathematical theory which underlies it. This theory says that sectional wave conductors (presumably in the form of inductance coils) can be made which will absorb almost completely all waves above or below a certain small range of frequencies, and the selectivity thus obtained has nothing to do with ordinary electrical tuning. In other words, the selectivity of the eye and of the ear can be imitated by coarse structures like sectional wave conductors. Electrical pulses produced by the static are for the most part very short and their action is equivalent to the action of highly damped electrical oscillations of very high pitch. This action can be entirely absorbed so that no part of it reaches the receiving apparatus of a wireless receiving station if between

the antenna and the receiving apparatus a sectional wave conductor is employed which will not transmit electrical waves of a fre-

(Continued on page 733.)

Electrical Losses in Radio Transmitting and Receiving Sets

By James L. Green.

PART I.

THE TRANSMITTING SET.

THIS article endeavors to deal with radio power losses and their prevention. The design and construction of commercial radio apparatus is now rec-

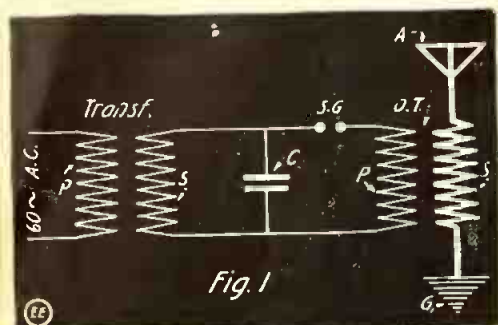

Fig. 1. Typical Radio Transmitting Circuit.

ognized as an important branch of engineering, and great care must be exercised so that the set will operate with the greatest all-around efficiency.

This requires that the electrical power losses be kept at a minimum and a maximum amount of energy radiated or received for a given input of power.

The equipment of a wireless station may be divided into two parts: 1. Sending set. 2. Receiving set.

Let us first consider the sending set: Take the average one-half kilowatt amateur set shown diagrammatically in Fig. 1, and consider the apparatus from left to right.

A. Sending Key.—The average amateur wireless key usually consists of an ordinary telegraph key with heavy contacts. Since the losses in a key are usually those due to heating of contacts and formation of oxides, dirt, etc., upon their faces, these may, by the use of *large studs*, be reduced until they are negligible. Other losses, i. e., at bearings may occur if these are allowed to work loose or become dirty or covered with oxides.

B. The Transformer.—For a full treatise on transformer losses the reader had best consult an engineering text-book on alternating current machinery. However, the more serious transformer losses are:

1. **Conductor Loss.**—Whenever a current traverses a conductor heat is developed. The amount of loss due to this heat is given by $W = C^2 \times R$, where W = loss in watts, C = current in amperes, and R = resistance of conductor in ohms. The copper loss is due to heating of the windings; and, to make this as small as possible, large wire must be used. There is, however, a limit to the size of wire used, as too large a wire makes the transformer bulky and thereby increases iron losses. For this reason transformers are nearly always designed with a certain copper loss—about 5 to 8 per cent.

Suppose now we wished to know the primary resistance for a transformer whose input = 440 watts and whose copper loss is 5 per cent. Then we can calculate the resistance for the primary of a transformer which on 110 takes four amperes.

$$\text{From } W = C^2 R$$

$$\text{We get } 22 = 4^2 R$$

$$\text{Whence } R = 1.375$$

Therefore, the primary resistance may be as high as 1.375 ohms for an allowable copper loss of 5 per cent.

In general the primary resistance of the amateur's transformer is less than this, so it is probable that the conductor losses of

the ordinary amateur transformer are quite low.

2. **Core Loss.**—The iron losses in transformer cores may be divided into two classes: viz., hysteresis and eddy currents.

a. **Hysteresis Loss.**—When iron is subjected to the action of a magnetic field produced by an alternating current its polarity will change with every reversal of the current. To this change of polarity the iron offers a resistance. The lag in responding to such a change produces heat and is known as *hysteresis*. This hysteresis loss is small in soft iron and increases with the hardness of the iron. It may be reduced by using very soft transformer iron and by keeping the volume of the iron small.

b. **Eddy Currents.**—Since a conductor placed in a varying magnetic field has a current induced in it the iron in a transformer core, being subjected to an alternating current magnetic field, has currents induced in it. These currents are known as Eddy or Foucault currents, and run crosswise through the core. Hence, to minimize them, we can make the core of thin laminations of iron, insulated from each other.

In commercial practise the laminations are treated with acetic acid for a few hours until a thin film of rust forms over them. This has one advantage over shellac, which is often used by the amateur, as no amount of heating can burn or melt it. In the ordinary amateur type transformer, if built of transformer iron, insulated as described, and used on 60-cycle A. C., the loss due to hysteresis may not be more than 5 to 8 per cent. of the input.

3. **Condenser Losses.**—The losses in a high tension condenser are of two kinds.

a. **Hysteresis.**—Since the two plates of a charged condenser contain opposite charges, i. e., one positive, the other negative, and as these plates are separated by a dielectric there is always a strain across the dielectric, due to the attraction of the two charges. This strain is known as an electrostatic strain. If the charging current be alternating, then the strain will be first in one direction, then in the other. The dielectric will display an effect similar to magnetic hysteresis; i. e., it objects to the change of direction of strain. This reluctance causes power loss and is known as *dielectric hysteresis* and its energy is expended in heat. The amount of hysteresis loss in a condenser varies with the material used in the dielectric. It is dependent on:

1. Chemical composition of the dielectric.
2. Temperature. It is very small in air condensers and those having transformer oil, or flint glass as dielectric and quite large for ebonite or micanite.

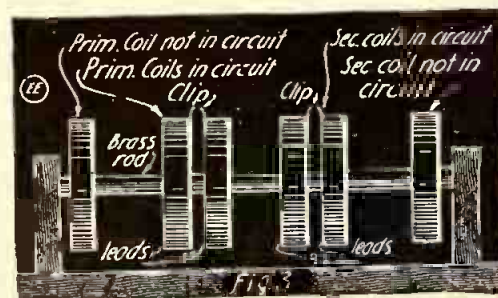

Fig. 3. Suggested Form of Loose Coupler Employing "Unit" Inductances Instead of Sliders or Switches.

b. **Brush Discharge.**—The coronas, or discharges of light, that issue from a highly charged conductor are known as *brush discharges*. They are most frequently noticed at sharp points or edges, and a portion of the charge is often thus lost in the air. This

discharge is often noticed in antennæ and inductances, and is a particularly serious form of loss; for, besides part of the charge being lost in the surrounding conducting layer of air, the capacity of the circuit will be changed and thus the set will be put out of resonance. To overcome brush discharge

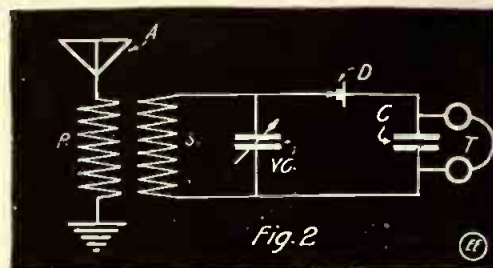

Fig. 2. Regular Wireless Receiving Circuit for Loose Coupled Tuner.

the condenser should have few, if any, sharp edges and should be of the oil-immersed type.

4. **Spark Gap.**—The losses in the spark gap are due to: a. Heating. b. Rapidity of quenching. The losses due to heating are usually small in the amateur set and, so far as these are concerned, almost any form of gap can be used. The quenching of a gap is determined by:

1. Material of gap. (Copper gaps quench most rapidly.)
2. Gas in which spark takes place. (Hydrogen and illuminating gas produce best results.)
3. Separation of the electrodes. (The gaps should not be closer than .01 inch. The spark should take place in an airtight chamber and the gaps provided with radiating flanges for cooling. In the larger gaps air blasts or water circulation systems are used to facilitate cooling.)

5. **Oscillation Transformers.**—These coils are really air-core transformers and serve the purpose of transferring the energy of the closed condenser circuit to the open antenna circuit. The preferred type of this transformer takes the form of two concentric, cylindrical coils wound with copper ribbon. It has been shown that by using a rapidly quenching gap and close coupling, a gain of 25 to 40 per cent. over the spark sets is readily possible.

6. **Antenna.**—The antenna losses may be due to:

a. **High Frequency Resistance.**—Since the currents in the antenna are of fairly high frequency the aerial should be of stranded wire, thus providing the greatest possible surface for the conductors used. The lead-in should be composed of a cable of the same wire as used in the antenna; the number of them being the same as in the aerial. This method should be followed in all cases.

b. **Induction in Neighboring Masses of Metal.**—Guy wires are very liable to give trouble in this direction unless broken up into short lengths by means of insulators.

c. **Leakage Through Faulty Insulators.**—This form of loss is only too well known and can only be remedied by using better insulators.

d. **Brush Discharge from Aerial.**—This form of loss was referred to under "Condenser Losses." It may be avoided by having no sharp ends or bends in the aerial wires and by having the "open" end of the antenna heavily insulated (since the voltage is higher at the farther end of the antenna). Use curved joints in all parts of the antenna, not square bends.

e. **High Resistance Ground.**—This is a

(Continued on page 728.)

... and some paraffine melted and ... in. A piece of hard rubber is fitted ... the mouth of the jar and two binding ... mounted on same for connections. Several of these can be made up to form an adjustable condenser. Paraffine oil is

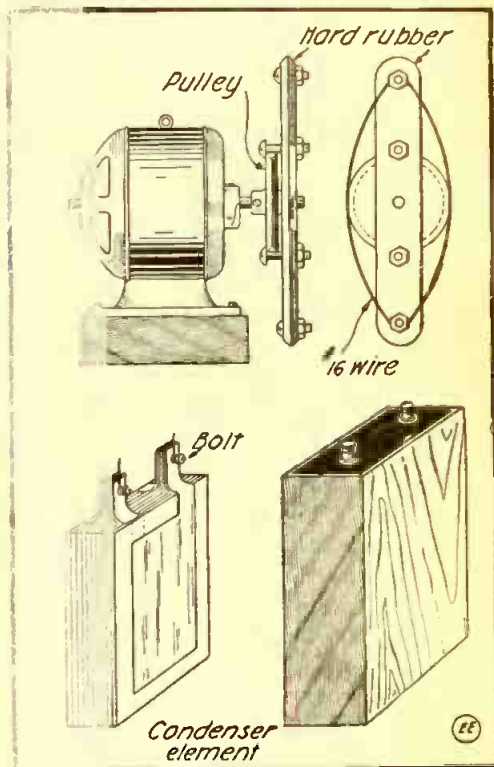

Rotary Spark Gap and Condenser Kinks.

... used in such condensers instead of

... an illustration showing a novel ... in which to mount the revolving mem- ... of a "Marconi type" rotary spark gap ... which I have made and know to be efficient. With this type of gap it is easy to obtain ... speed on account of the lightness of the rotating arm. I think the sketch is self-explanatory. With a small motor it gives a good, high pitched spark on only six volts. Would suggest that 12 stationary studs be used mounted in a hard rubber ring. The hard rubber used can be taken from an old storage battery jar.

Contributed by
RAYMOND H. CAMPBELL.

AMALGAM RECIPES.

... and mercury combine readily at ordinary temperatures. If 3 parts mercury be brought into contact with 1 of tin 6-sided crystals of tin amalgam are formed. Tin amalgam is used for silvering looking glasses. When pulverized and rubbed on the polishing stone it forms a kind of mosaic silver. Electric amalgam may be made by melting tin and zinc together in various proportions in a porcelain crucible. The mixture is well stirred up, and when on the point of solidifying the mercury is added and worked into the mass. The whole is next transferred to a mortar warm enough to keep the amalgam soft, with a piece of tallow or lard, not quite equal in bulk to the mass, is kneaded in until the amalgam attains the proper consistency.

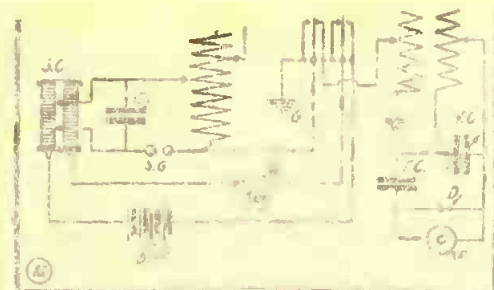

Radio Break-in Station

CONDENSER AND SPARK GAP

A comparatively simple and efficient condenser can be made from a glass jar of any size. The jar should be cleaned thoroughly at a

Old photographs ... it enough in the ... equal way with ... side ... the ...

... Powdered Alum in strong Vinegar, Oil of Star or fine Emery are often used to remove rust. Kerosene or Turpentine, if left on the stained or rusted portions overnight will sufficiently soften the rust so that it may be removed by the use of fine emery cloth followed by a polishing powder.

HIGH TENSION LEAD-OUT.

This lead-out terminal post is intended for use on radio transformers and condensers, but, of course, it may be used in any other place as a high tension bushing. It consists of hard rubber tubing $1\frac{1}{2}$ inches in diameter and with a $\frac{1}{4}$ -inch wall. The drawing needs little explanation. The dimension A should be whatever the diameter

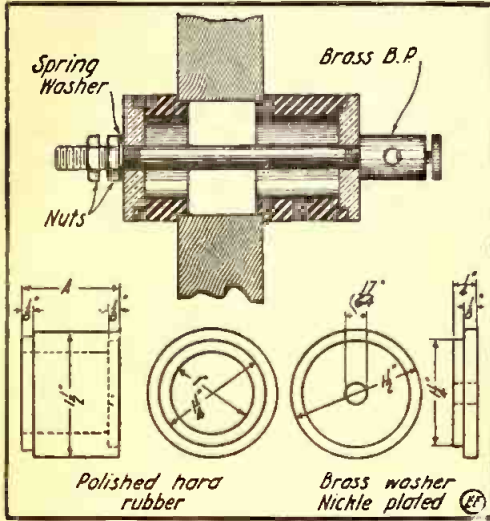

Hard Rubber Tube Forms Efficient Lead-Out Insulator.

of the hard rubber is, in this case $1\frac{1}{2}$ inches. The short piece should be one-half of the length of the outside one. The hard rubber tubing should be machined as per drawing, and the binding post and outside brass washer should be nickel-plated.

The brass rod should be threaded into the end of the binding post and fitted with two hexagon nuts and a spring washer. The rod should be of such length as to tightly clamp the hard rubber pieces as shown. In the assembled drawing is seen the lead-out complete, mounted presumably in a condenser or transformer base.

This insulator is easily made, is highly efficient and will add a "commercial" touch to any amateur equipment.

Contributed by
THOMAS W. F. DRURY.

HOW TO ERECT AN AERIAL MAST.

Many amateurs have great difficulty in raising an aerial mast. The method here described practically eliminates all difficulty.

Drive two five-foot wooden stakes into

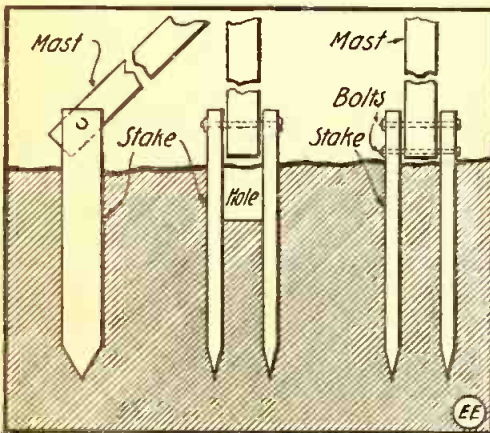

Erecting an Aerial Mast.

the ground so that but one foot of each projects. The space between the stakes should be a little more than the thickness of the mast. Then dig a hole, in which the mast is to be placed when erected, between the two stakes. Drill half inch holes in both stakes as well as in the

QUEEN DECORATES WIRELESS OPERATOR.

Arthur Hankin, a former Trempealeau, Minn., boy, who until a few months ago was a wireless operator aboard a British warship in the Far East, is convalescing in a hospital in England after a long illness. Writing from the hospital, he tells how he was recently decorated by Queen Mary with a slip of heather. He says:

"I had the pleasure of shaking hands with King George of England and Queen Mary. Also, they both wished me a speedy recovery. The king and the queen arrived at the hospital early in the day and we were lined up to receive them. They came to each of us and shook our hands and asked about our experiences and where we had been stationed.

"The queen's lady-in-waiting had a bundle of white heather, and the queen handed each officer a piece, and she was kind enough to say she hoped it would be lucky to us."

TRANSMITTING CONDENSER CONSTRUCTION.

Below are shown details for constructing a useful and efficient form of the glass plate transmitting condenser for radio sets. The slide plates are readily remov-

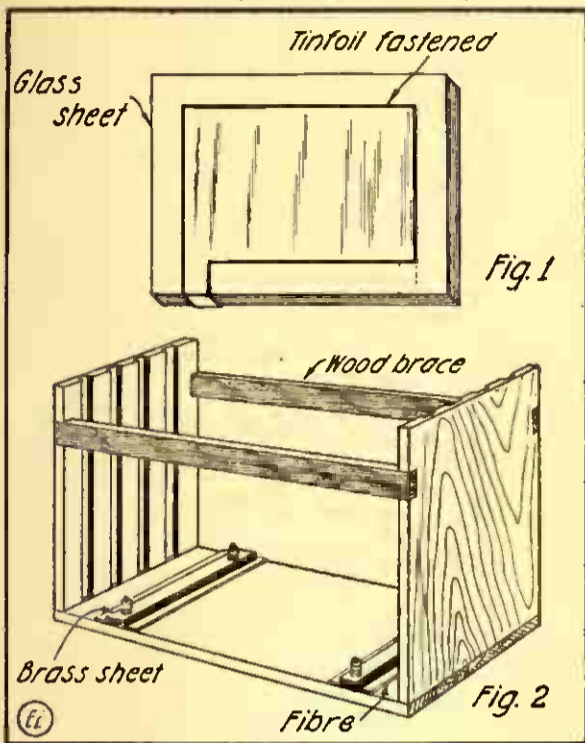

Rack for Holding and Automatically Connecting Glass Condenser Plates.

able from the frame, as will be perceived, so as to make it of any capacity desired. Fig. 1 shows how the glass plates are coated on both sides with two tinfoil sheets. As is the usual plan, the lug from each sheet is carried down to the edge of the glass and passed across this edge in the manner shown. Now by glancing at Fig. 2 it is apparent how the alternating tinfoil on opposite sides of the glass plates are connected with the circuit at the plate edge as they are slipped into the frame, where the foil lugs rest on metallic strips at the base of the frame proper.

The frame itself may be constructed of wax-impregnated wood, or of fiber, hard rubber, etc. Photographic negatives make good condenser plates, as they are usually quite free from air holes. To remove the gelatine from the surface all that is necessary is to soak them in hot water for a few minutes, when the coating can be easily scraped off.

Contributed by P. J. ROBE

ALUMINUM WIRE FOR AERIALS.

My small antenna for 200-meter waves was composed of six No. 14 aluminum wires, fastened to heavy 17-foot spreaders. When it had been up about a month one of the wires broke at the spreader. A few days later another broke at the same point. This was followed by a break at one of the porcelain cleat insulators. Then I decided to make some changes. When I first fastened the wires to the spreaders and insulators I did it in the manner shown by Fig. 1 of the drawing. With copper wire no break would have occurred but aluminum wire cannot be bent many times without breaking it. The spreader, as it swung up and down in the wind, bent the wire, though slightly, at the point marked by the arrow. When I fastened the wires again I used the method shown at Fig. 2. I passed the wire around the spreader, or through the hole in the insulator twice and did not twist it as closely as in the first case. This left no sharp stop where the wire could bend. It also strengthened the wire at the point of greatest strain.

I also put on new spreaders of cypress one inch square and nine feet long. Cypress is strong, light and withstands the weather better than other woods. Later I took off two of the wires. When using four wires, instead of six, there is no difference in the strength of the signals in receiving. I am heard by other stations just as loud. The antenna worked no better with more wires spaced farther apart.

I found the lead-in wires were so oxidized at the joints where the tape was soaked through the tape—the joint

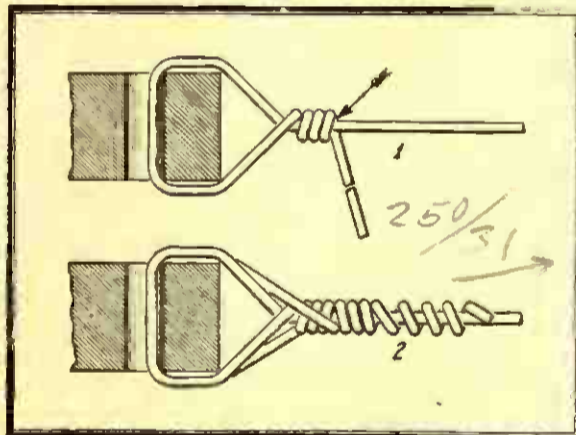

Method of Making Joints in Aluminum Wire Aerials.

not been soldered. In place of the tape I put on paraffined cloth. The cloth was simply run through the melted paraffin twice. After winding a few turns of wire around the cloth-covered joint I heated it with a match to remelt the paraffin inside. This made the joint watertight without the trouble that soldering entails. The aerial has been up five months without giving any trouble.

[NOTE.—On account of the above and similar troubles, aluminum wire for aerials is not used any longer in modern wireless stations, phosphor bronze or the so-called "copper-clad" or "antennium" wire being used exclusively now. It is cheaper and better than aluminum.—EDITOR.]

Contributed by MILTON B. SLEEPER.

RECEIVES RADIO FARTHEST IN DARK.

I find that when receiving weak radio signals that by making the room dark the signals seem to come in much louder. The reason for this is that in a dark room you cannot see and therefore your sense of hearing is much keener.

Contributed by M. STIENER.

[This is a fact not at once conceivable perhaps, but on reflection it is seen that if we do not tax the other senses, such as sight, that the sensitiveness of the ear is readily augmented.—EDITOR.]

TRUCTOR



d Construction of a Decremeter

Part II.—Conclusion

By Milton B. Sleeper

Assembling the Decremeter.

First fasten the coils in the case with the brass straps. Next, screw the parts on the front. See that the switch is in proper alignment with the pointer; make sure that the condenser plates do not touch; have the slider moving smoothly in the slot. No dimensions for the detector have been given, as any good model will do. The stand in Figs. 1 and 4 is of a very convenient design, however.

Fig. 10 shows how the connecting wires are run on the back of the hard-rubber panel. Use heavy, stranded, flexible rubber covered wire. *Small wires increase the damping of the instrument.* If the damping is too large the meter will be inaccurate. Leave enough wire on the switch connections, to allow the contacts to move freely. Before screwing the front to the case go over the connections; be sure that

where:—

- δ = decrement of the transmitter,
- λ = wave length of the transmitter,
- n = number of turns in 'phone circuit, when faint signals are heard.
- λ_1 = wave length of circuit when it has been changed a small amount from that of the transmitter,
- n_1 = number of turns in the 'phone circuit required to bring signals back to their former strength.

When the switch is in position 1, as indicated by the pointer, Fig. 1, or in position 3-4, of the back views, the small coil is in series with the long coil and condenser. The 'phone is connected across 26 turns of the long coil. Now, if the condenser is adjusted to put the circuit in resonance with the transmitter,

- λ = wave length of the transmitter, and
- $n = 26$ turns.

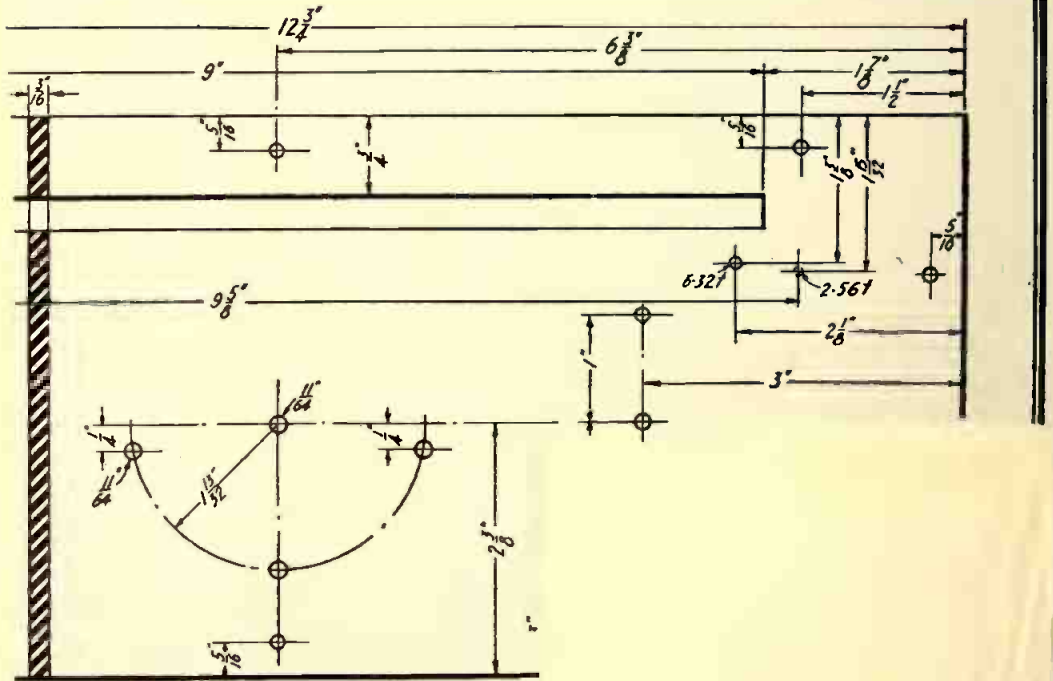

Fig. 8

of Decremeter Switch Panel, Showing Dimension

they are exactly right. With everything adjusted, the meter is ready for use.

Use of the Decremeter.

Some understanding of the principles of the decremeter are necessary if the instrument is to be intelligently used. In Fig. 11 the circuit 1-2-3-4 resembles that of a decremeter as well as that of a wave meter. V. Bjerknes has proved that when this circuit is tuned to a transmitting set,

$$\delta = \pi \left(1 - \frac{\lambda}{\lambda_1} \right) \frac{1}{\sqrt{\left(\frac{n_1}{n} \right)^2 - 1}}$$

To summarize the operations in finding the decrement of a transmitter:—

always be sure that the wave lengths of the closed and open circuits are the same. If

former, even though the radiation is decreased, until the decrement is 0.2. If the

Fig. 9. Details of Decremeter Case. To be made preferably of hard wood, well polished, such as mahogany or quarter-sawn oak. Three coats of shellac or varnish, each rubbed smooth with pulverized rottenstone and linseed oil, will yield a fine, glossy finish.

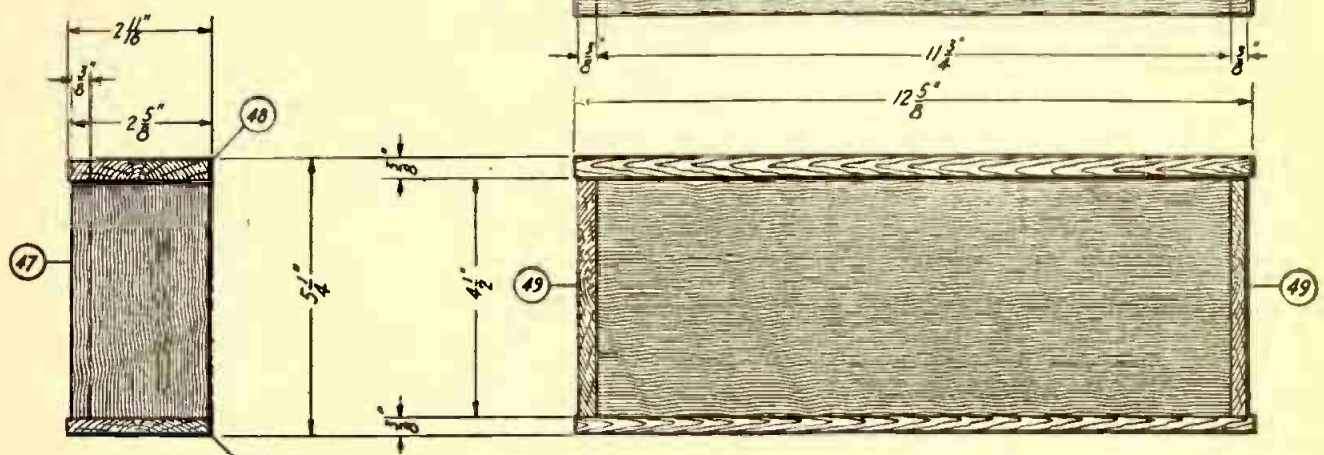

Fig. 9

1. Put the switch in position 1.
2. Place the meter about five feet from the helix.
3. Adjust the detector until sounds are heard in the 'phone when the key is pressed.
4. Turn the condenser until signals are loudest. Do not touch the condenser again.
5. Move the decrometer away from the transmitter until the signals are barely audible.
6. Change the switch to position 2.
7. Adjust the slider until the signals are exactly as loud as they were before the switch was changed.
8. The decrement of the transmitter will be indicated beneath the pointer on the scale.

Tuning a Transmitter with a Decrometer.

The decrometer can be used for a number of practical purposes. A decrometer can be used as a wave meter; the wave length being read from the condenser scale. In this case have the meter calibrated when the slider is at the extreme right and the switch in position 2. Always adjust it in

the meter is not calibrated to read as a wave meter it can still be used to bring the circuits into resonance. The method is as follows:—

1. Disconnect the antenna and ground from the oscillation transformer or helix.
2. Adjust the closed circuit for maximum efficiency with a hot wire ammeter or by the appearance of the spark.
3. Put the meter a few feet from the set. With the switch in position 2, adjust the slider roughly, and finally the condenser, for a maximum response in the 'phones when the key is pressed. Do not change the slider again. Note the reading of the condenser.
4. Connect the antenna and ground. Disconnect the closed circuit from the helix.

decrement is so high that it cannot be sufficiently reduced by loosening the coupling, without greatly reducing the radiation, there is something wrong with the con-

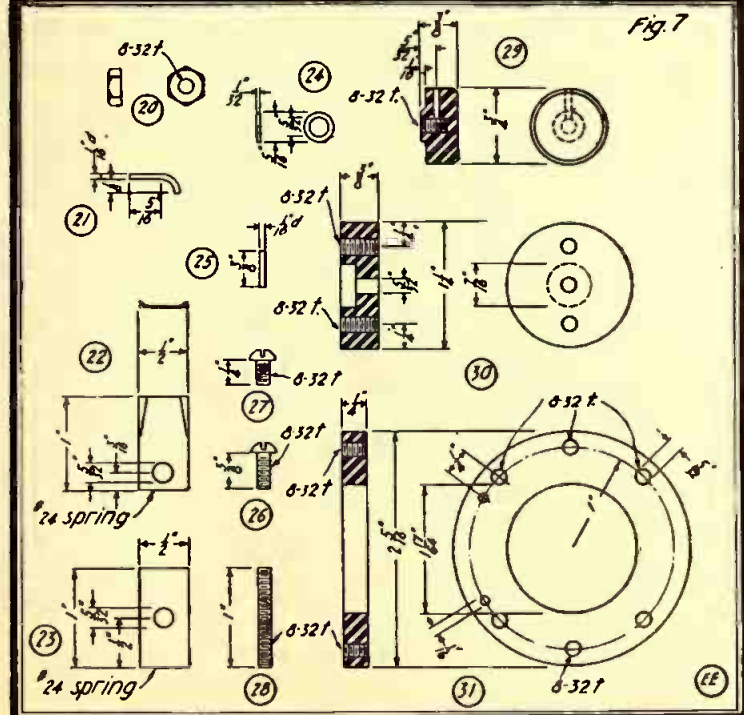

Fig. 7. Change-Over Switch Details.

this way when using it as a wave meter. Before measuring the decrement of a set

ure the decrement. If it is too large, separate the coils of the oscillation trans-

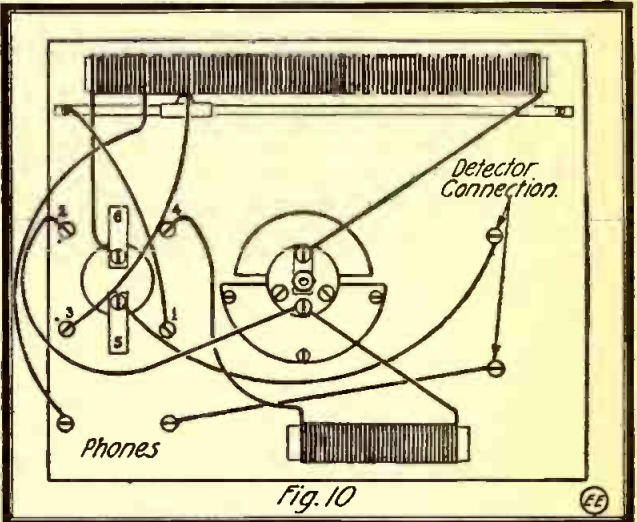

Fig. 10. How Parts of Decrometer Are Connected.

5. Adjust the clips until the maximum response in the 'phone is at the same position on the condenser scale as with the closed circuit. Now the two circuits will have the same wave length.

When the circuits are in resonance adjust the coupling until the hot wire ammeter in the antenna indicates a maximum radiation, or until the signals are heard loudest at a near-by station. At this point measure the decrement. If it is too large, separate the coils of the oscillation trans-

struction of the set. The two circuits must be out of resonance, the resistance of the antenna must be too large, the ground connection poor, or the spark gap may be at fault. Any form of resistance in the antenna circuit will increase the decrement.

It is interesting and very useful to calibrate the decrement of the transmitter on a scale fitted to the oscillation transformer frame. If the station is equipped with a wave meter, the two radiated waves can be measured and set down beside each decrement reading. The decrement of a transmitter will change slightly in wet weather, or when the spark gap is changed. It is convenient, when calling a station to increase the decrement, or broaden the wave, by moving the coils of the oscillation transformer nearer together. This interfering wave will be heard by the station called, even though it is tuned to a wave higher than 200 meters. After an acknowledgment has been received, reduce the decrement to the legal limit. During interference the

decrement can be further reduced, if necessary, for the lower the decrement, the

outside diameter. This tube is easily made from a pasteboard box, which may be procured at any grocery store. This is also true of the secondary tube. The length of the primary tube is not shown in the illustration because there is a great variation in the thickness of the insulation of the different kinds of wire. There should be just enough space between the end pieces to accommodate 21 turns of the wire used. If No. 14 D. R. C. wire, which is almost $\frac{1}{4}$ inch in diameter, similar to that for electric light wiring, is used the space on the tube should be about 4 inches for 21 turns. This wire can usually be obtained, although stranded wire is preferable.

pletes the construction of the coil. The woodwork may be finished with any sub-

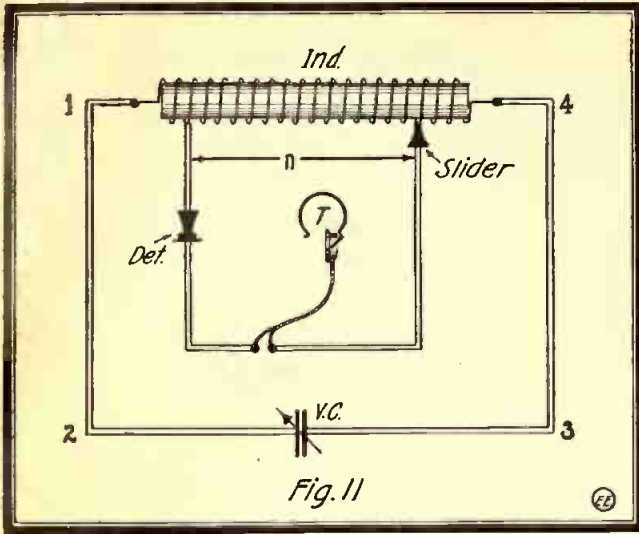

Fig. 11. Hook-up for Decrometer. (Schematic.)

more sharply a station can be tuned at the receiving set.

If the decrometer is calibrated to read as a wave meter it is possible to plot a curve representing the tuning characteristics of the radiated wave in the following way: Put the switch in position 2. Adjust the condenser to a wave length below that of the transmitter, and move the slider to the left until the signals are barely audible in the phone, when the key is pressed. On a piece of cross-section paper measure up from the bottom a distance to represent the number of 1/100ths on the scale. Move the condenser to a position 10 meters higher. Again find out the number of turns required to make the signals just audible. Measure a distance to the right of the first line to represent the increase in wave length, and upward a distance to represent the number of scale divisions now indicated by the pointer on the slider. Plot a number of points in this manner, both above and below the wave length of the transmitter. Then connect these points by a smooth curve. If the decrement is small, and if the set can be sharply tuned at a receiving station, the curve will be quite sharply peaked.

The decrometer described in this article, particularly when calibrated as a wave meter, is one of the most useful pieces of auxiliary apparatus for any radio station. It is hoped that this description of the instrument will help to popularize the decrometer with experimenters by clearing up some of the points not understood about its construction and use.

AIR-INSULATED TESLA COIL.

Experimenters who have wireless sending stations have all the apparatus necessary for the operation of an air-insulated Tesla coil.

The coil here described is suitable for use with spark coils giving from a 2-inch to 6-inch spark or with a $\frac{1}{4}$ -kw. transformer.

The coil described in this article will give a $7\frac{1}{2}$ -inch spark when used in connection with a $\frac{1}{4}$ -kw. closed core transformer (magnetic leakage type), glass plate condenser and a rotary spark gap. When a stationary gap is used the sparking distance is about 5 inches.

The illustration gives the necessary dimensions and shows part of the primary and secondary tubes cut away to bring out various points in the construction.

The primary consists of 21 turns of No. 14 B. & S. gauge rubber-insulated wire wound on a paper or fiber tube 6 inches

ered may be used) wound on a tube 3 inches outside diameter. The winding should be $11\frac{1}{2}$ inches long. The base and woodwork may be of any size the builder desires. The posts, however, must not be lower than indicated or the spark will jump into the primary winding.

The framework may be made of most any hardwood, or it can be made of poplar, but hard pine should not be used. The coil should be put together entirely with wooden dowels, because if nails or screws are used the sparks will jump into them.

The posts may be forced into half-inch or larger holes bored in the base to receive them and should be held with glue. The tubes may be fastened to the end pieces with glue, but it is preferable to fasten the larger tube into its end pieces by cutting a hole in each piece just large enough to allow the tube to slip into each end and fit snugly. See illustration showing the construction of these end pieces.

Holes may be bored in the base and in the end pieces to fasten them together with wooden dowels and glue. This is accomplished as easily as by using screws.

The next thing is to fasten the secondary into place. The best way to do this is to insert the two dowels projecting from the end of the secondary into the two holes bored in the upright posts to receive them

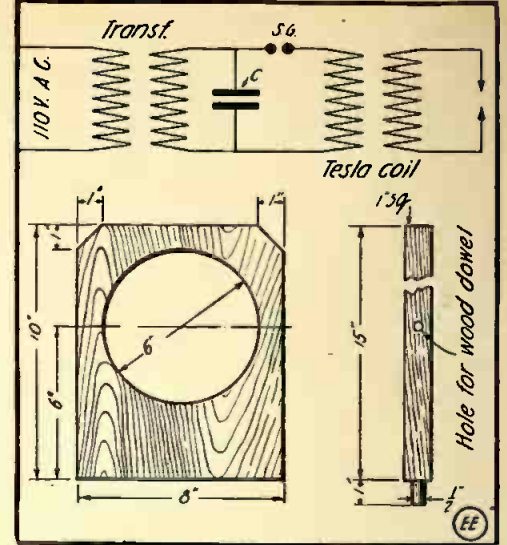

Frame Details and Hook-up for $\frac{1}{4}$ Kw. Tesla Coil.

stance that is a good insulator.

The size of the condenser will depend upon the spark coil or transformer used and will have to be determined by the experimenter. For spark coils of about 2 inches a half-gallon Leyden jar may be used, but with larger coils the number of the jars should be increased until the correct capacity is obtained. This would also be true of plate condensers.

Very beautiful experiments may be performed with this coil in a dark room. The spark may be allowed to jump to a piece of metal held in the hand, but no sensation of pain will be experienced. If the spark jumps directly into the body only a slight burning sensation will be felt.

Lubricating oil may be placed on the end of the finger and lighted by means of the spark without burning the finger.

A very surprising and beautiful, as well as weird, effect may be produced by connecting small cotton-covered magnet wire, No. 32 or smaller, to each terminal of the secondary and leading them off to the side of the room, keeping the wires about a foot or two feet apart. It is, of course, understood that all Tesla experiments should be performed in absolute darkness, as the desired results may be obtained only in this way.

Another experiment is to ground one wire of the Tesla secondary and attach a piece of wire to the other secondary. This will cause an enormous brush effect on the free wire.

Scores of other equally interesting experiments may be carried on, but these the experimenter may easily find out for himself.

The writer will be pleased to hear from those who build this coil.

Contributed by

LEONARD R. CROW.

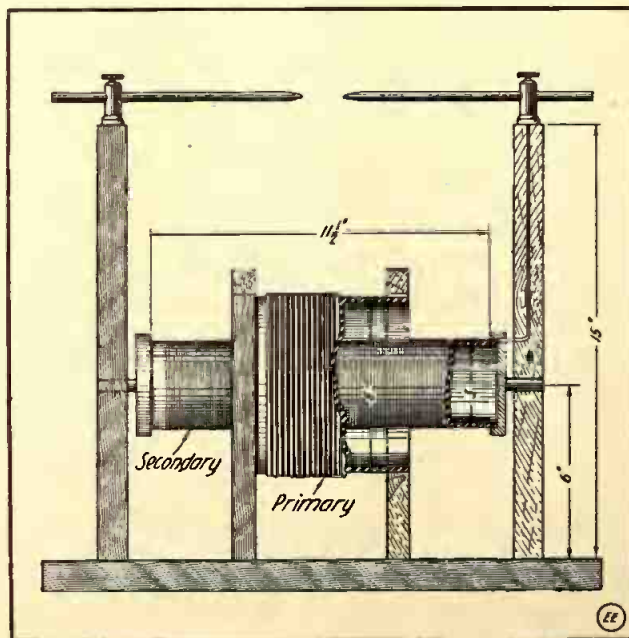

Well Designed Tesla Coil. Will Give 7 to 8 Inch Spark When Used on $\frac{1}{4}$ Kw. Radio Transformer.

and gently drive both posts into the holes made in the base for them. This com-

"Solder-all."

Contributed by OLIVER PARKER.

USEFUL BICYCLE HEAD LAMP.

This idea is original as far as I know, the light and battery being self-contained and mounted on the handle bars. I can imagine that this piece of apparatus will make quite a hit with those fellows owning an up-to-date bicycle built along motorcycle lines. I will not give dimensions as I believe each constructor will follow his own particular ideas. A box is con-

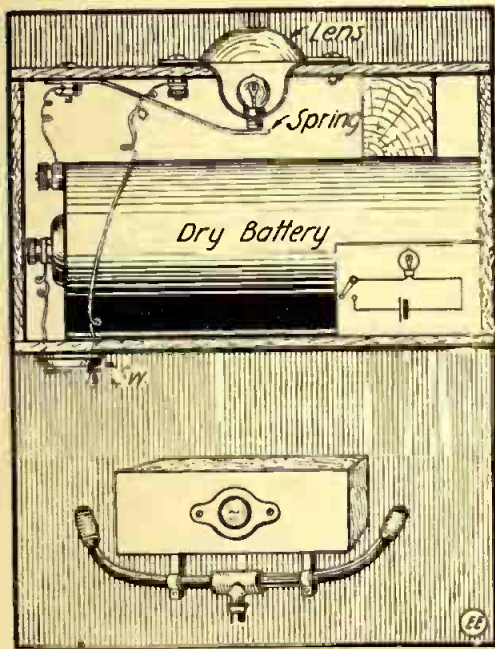

Bicycle Head Lamp Made to Use Standard Dry Cell.

structed such that will give the battery a snug fit, so as to eliminate movement. A flashlight is procured, one of the pocket type. A very cheap flashlight will suit. Cut out the parts, as shown, the correct size and lines being left to the constructor. Mount this, as shown, on the proposed front of the box. A piece of spring metal connects the bottom contact of the lamp. A switch is mounted on the side nearest the rider, preferably one with removable blade such as the Keystone switch, so that no one will tamper with the light when the rider is otherwise occupied. The cover may be provided with hinges or screwed on. A block of wood wedges the battery in the case tight. Purchase from a bicycle supply store two frame pump holders, which will cost a few cents. Cut as shown and screw onto the box, mounting same on handle bars, as indicated. The diagrams, I think, are self explanatory.

Contributed by W. J. ADAMS.

HOW TO MAKE AN ELECTRIC THERMOMETER.

The experimenter who is intensely interested in general research work should not by any means miss an electric thermometer in his laboratory. The commercial thermometers of this class are very expensive, and this is one reason why the experimenter generally lacks such an instrument. The Pyrometer, as it is technically called, and herewith described, was built by the writer, who used it successfully in connection with an electric furnace developing 2,000 degrees Fahrenheit.

The detecting apparatus consists of a thermo-couple made especially for high temperature. The first thing is to obtain a short piece of No. 20 platinum wire about 2 inches long and a piece of tungsten wire of the same gauge and length. One end of each piece should be welded together to form a single long strip. This can be readily accomplished by splicing them together and heating to a bright redness in a

Bunsen burner, or still better, in an oxy-acetylene gas burner. After this is done two long copper wires B B are next welded onto each end of the loop, Fig. 1. The welding is done in the same manner as with the other two wires, but care should be taken not to heat them too long, as the copper ones are apt to fuse on account of the low melting point of copper compared with tungsten and platinum. The wires are now placed in an 8-inch porcelain tube, which is then filled with a concrete mixture, or even better, with lime (calcium carbonate), saturated in water and allowed to dry. This mixture keeps the wires in place and at the same time will keep the interior wires from overheating during the use of this apparatus.

The recording device B, Fig. 2, consists of an ordinary milli-voltmeter with a scale calibrated in degrees instead of in millivolts. The scale should be removed and another scale without any figures or marks replaced. It is now ready to be calibrated. Both instruments should be connected as shown in Fig. 2. The detecting apparatus is placed in a furnace giving a temperature averaging about 200 to 300 degrees Centigrade; then carefully insert a standard mercury thermometer into the same furnace. The standard must read 300 or more degrees, as the temperature of the furnace will cause the mercury to reach its limit until it will force itself through the bulb, thus damaging the instrument. Read the scale on the mercury thermometer and note the deflection of the pointer on the milli-voltmeter scale. Mark off a point and, if possible, increase the temperature of the furnace and take another reading, marking another scale point. The figure obtained on the standard should be noted on the scale of the unknown. Marking these two points, the rest of the scale is equally divided and spaced according to the divisions previously found. It should read to 2,000 degrees.

For those who are not familiar with the operation of this instrument, a few words will suffice. Whenever any two dissimilar metals connected together are heated or cooled below the temperature surrounding these conductors a current of electricity is set up, which in turn registers on the milli-voltmeter scale. The current produced by the thermo-couple is directly proportional to the heat produced by the furnace; therefore heating the two wires with a greater temperature produces a greater deflection on the indicating device, etc.

Having completed the outfit, the instrument is now ready for actual use. This electric thermometer will be found extremely useful in laboratories where an

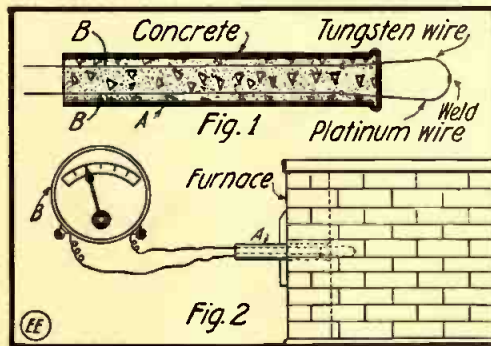

Electric Thermometer Parts and Use of Same in Furnace.

electric furnace is used for producing refractory substances and artificial gems. Contributed by S. CROW.

Are you a contributor to this department of The Electrical Experimenter. If not—why not?

CLEANSING MERCURY BY WASHING.

While distillation under reduced pressure is the most satisfactory method of removing impurities from mercury, it is often sufficient to wash thoroughly with diluted nitric acid. As usually performed this is rather a messy undertaking, but by means of the apparatus illustrated on this page the trouble is reduced to a minimum.

The washer consists of a mercury reservoir A and a tall glass tube B open at both

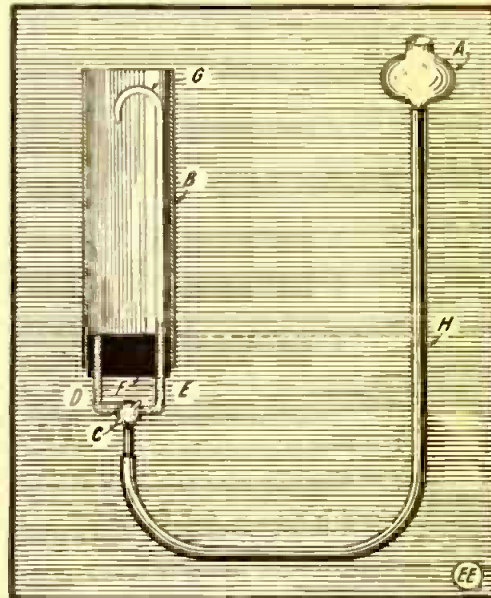

Mercury Cleansing Scheme.

ends, the capacity of the latter being several times that of the former. A three-way tap C is also required. Two of the side tubes D and E are bent upward and passed through an India-rubber cork, F, closing the lower end of the large tube. To one of these is attached the glass tube G, which reaches almost to the top of the wide tube and is bent downward and drawn to a fine jet at the end. The other tube D should be flush with the cork. A length of pressure tube H makes a flexible connection between the reservoir and the tap.

The soiled mercury, having been placed in the reservoir A, and a quantity of diluted nitric acid in the wide tube B, the action proceeds as follows: Upon raising the reservoir to the position shown in the illustration and putting it in communication with the tube G by means of the three-way tap, a thin stream of mercury will pass through the column of acid, collecting at the bottom of the tube. The reservoir may then be lowered as far as it will go and the tap adjusted so that the mercury flows back through D. The operation should be repeated several times to insure thorough cleansing, the reservoir being supported in the upper and lower positions respectively by means of a wire cradle and hooks, or in any other convenient manner. The mercury should afterward be washed in clear water and dried by heating in a glass or porcelain basin to just above the boiling point of water. Contributed by

H. J. GRAY.

Don't test storage cells with an ammeter. It forms a complete short circuit and will eventually ruin the cells. Use a voltmeter. Don't use lighted matches to examine storage cells. The gas given off forms an explosive mixture.

Safety first—don't handle electric wires even though they are 'phone wires. They may have become crossed with a high voltage transmission line, which means instant death.

A HANDY HOME-MADE WATER MOTOR.

A very useful water motor that will run a small dynamo or a sewing machine on a pressure of about 30 pounds water pressure can be made at a very small expense.

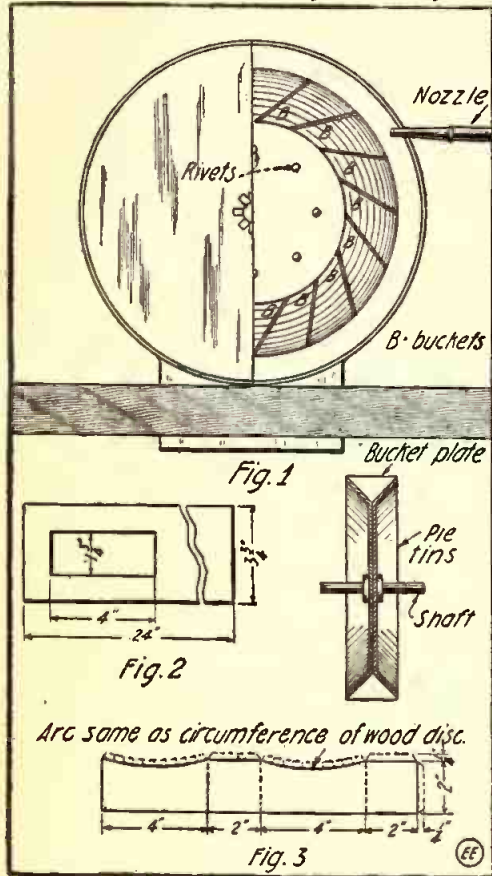

A Home-Made Water Motor for Experimenters.

Procure two 7-inch flaring edge pie plates 1 inch deep. Find the exact center and punch a pin hole through the bottom of each plate. Place the plates with their bottoms together and hold their centers in line by placing a pin through the holes. Rivet the plates together, using eight rivets spaced equal distances apart on a circle 4 inches in diameter. Then solder the joint all the way around the plates.

Cut 16 triangular pieces of tin to fit between the edges of the plates (see sketch). Solder them at uniform intervals around the plates, between the diverging edges. These form the buckets and should be placed at an angle, as shown in Fig. 1.

After the buckets have been finished drill a 1/4-inch hole through the center of the pie plates for the shaft. Slip a 1/4-inch brass rod through the hole and solder it in place. Be sure that the rod is perpendicular to the plane of the wheel. The shaft should be at least 6 inches long. Solder a brass thrust collar 1/4 inch thick and 1/2 inch from the bottom of the plates on the shaft. There should be one on each side of the wheel. Now saw out two round hard wood discs of wood 1/2 inch thick and 7 1/2 inches in diameter. Boil them in paraffine to make them waterproof. Drill a hole through the center of each, just large enough to admit the bearing. The bearings are made of brass tubing having an inside diameter of 1/4 inch. Take a piece 1 inch long and with a hack saw cut six slots in one end 3/8 inch deep. Then bend out the end of the tube at right angles to itself. Make two bearings in this way and fasten one in each wooden disc with screws. Next cut out a piece of tin 24 inches long by 3 3/4 inches wide. In the center of same cut a hole 4 inches by 1 3/4 inches, as shown in Fig. 2.

Punch holes 1 inch apart and 1/4 inch from the edge on each of the long sides. Wrap the tin around the edge of one of the wooden discs and tack it tightly in place. Then place a brass washer on each end of the shaft and put the wheel in place. Now slip on the other disc and tack the tin to it. Solder the place where the ends of the tin overlap. Next cut out a piece of tin the size and shape shown in Fig. 3 for the spillway. Fold the tin on the vertical dotted lines and solder the overlapping ends. Bend the edges at right angles and place the spillway over the bottom hole in the cylindrical casing. Solder it carefully in place. The nozzle is made of an oil-can spout, cut off so that the hole is about 1/4 inch in diameter at the smaller end. Solder the spout to a hose connection. Now drill a hole in the center of the casing as in Fig. 1. Connect the nozzle to the faucet by means of a short length of hose and turn on the water. Ascertain the position of the nozzle where the maximum speed is obtained, then solder it firmly in place. Next cut off one end of the shaft close to the casing. Allow the other end to protrude far enough to hold the pulley. The pulley may be of the flat or "V" grooved type and can be fastened to the shaft with a wedge key or set screw. The pulley should not be over 2 1/2 inches in diameter. Contributed by **KENNETH KRUGER.**

A PRINTING TABLE FOR AMATEUR PHOTOGRAPHERS.

A very convenient printing table for the amateur photographer may be made as follows: Any table may be used, but one with

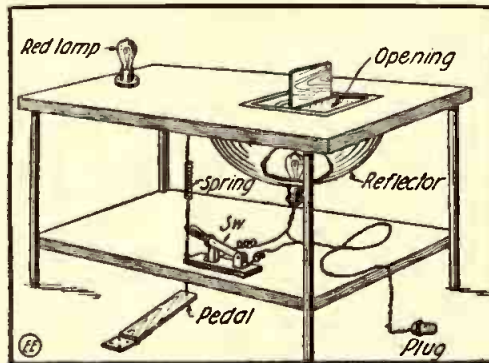

An All-Around Electrically Lighted Printing Table for Photographers.

a lower shelf between the four legs of the table is desirable. First cut a hole in the top of the table just large enough for the printing frame to slip in. Strips of thin wood are tacked to the under side of the table top, so that the printing frame rests upon them. A single-pole, single-throw knife switch is next mounted on the shelf underneath the table. To the blade of the switch is fastened one end of a coiled spring. (An old curtain spring will do). The other end of the spring is then fastened to the under side of the table top and adjusted so that the switch is normally open-circuited. A string is then fastened to the handle of the switch blade and run through a small hole in the shelf to a suitable foot treadle made of wood. One end of the foot board is hinged to the floor and the other end is held a few inches above the floor by the string attached to the switch blade.

An incandescent lamp of the desired candlepower is stationed directly beneath the printing frame and about 10 inches from same. A good reflector, such as a tin basin, will add to the intensity of the light. It is best to white enamel the inside of the reflector. When the foot plate is depressed it closes the circuit through the switch and lights the lamp. Upon re-

leasing the pressure on the treadle the spring causes the switch to become open-circuited, thus extinguishing the light. By means of this arrangement both hands are left free for the printing operations. A red lamp may be kept constantly burning over the table if desired. All connections are clearly shown in the diagram.

Contributed by **WALTER F. CURRENT.**

USING MOTOR AS TRANSFORMER.

The experimenter finds himself oftentimes in need of a transformer to reduce the voltage of the ordinary alternating-current house lighting circuit down to a point where it can safely be used in connection with miniature lamps, bells, small motors and other apparatus. A bell transformer, which is a cheap enough instrument to buy and which, in fact, is quite readily made by anyone who is handy with tools, is just the thing for this purpose, but it sometimes happens that an instrument of the sort is wanted at a moment's notice, and a substitute would thus come in very handy. In such a case it is well to remember that an ordinary shunt wound, direct current fan motor, properly connected to the alternating-current lighting circuit, will serve the purpose of a transformer. Of course it is not as efficient as a device which is wound expressly for the purpose of stepping down the lighting circuit voltage, but nevertheless it can be used and therein lies its chief virtue.

For the purpose it is necessary to use the field circuit of the fan motor as the primary of the transformer. To do this, disconnect the field entirely from the armature circuit and hook it up to the lighting current, as plainly indicated in our illustration. Hook up the apparatus to be run by the low voltage to the brush terminals and it will be found that, with the lighting circuit on, an alternating current at about six volts—it depends a whole lot on the winding of the motor—can be taken from the armature of the fan motor. It is possible to alter the potential of the transformer current slightly by shifting one of the brushes on the commutator, so as to in-

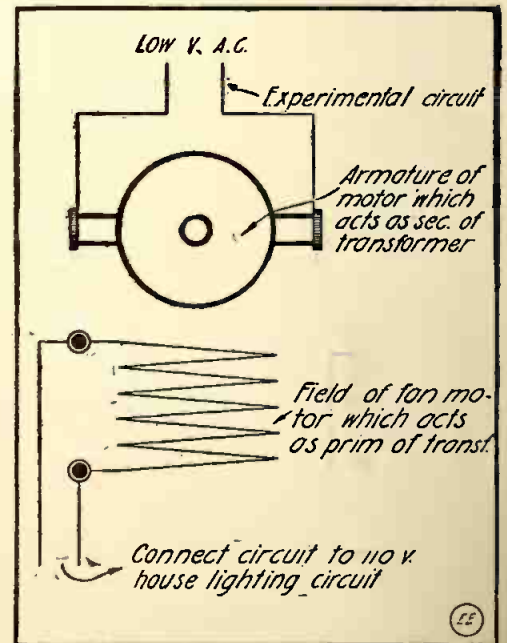

Using a Small Motor as an A. C. Step-Down Transformer.

clude two or more coils. It is not well to try the experiment with a series wound motor, since neither the resistance nor the inductance in the field of the series motor will be found sufficient to prevent short-circuiting of the house current. Contributed by **E. F. HALLOCK.**

USEFUL TELEPHONE HOOK-UPS.

The telephone circuits which are described in this article are those being regularly used by a large telephone manufacturing company and they will undoubtedly prove of value to the young electrician.

Figs. 1 and 2 show two party systems,

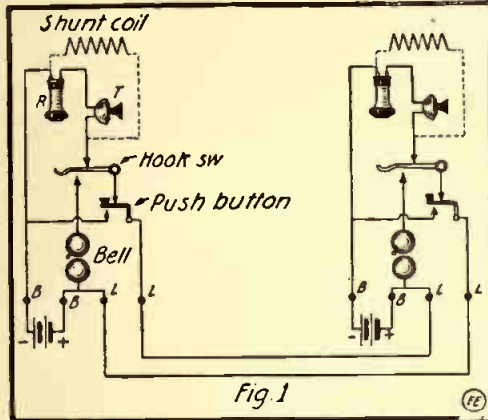

Fig. 1. Hook-up for Plain Series Telephone Set.

one employing two line wires and two sets of batteries and the other utilizing three line wires and but one set of batteries, located at any convenient point between the terminals BB. In case it is desired to use no "call" push button on either of these systems a shunt coil (a small coil of wire) can be bridged across the transmitter and receiver as indicated; its resistance depending on the resistance of the bells. Apparently the transmitter and receiver is short-circuited, but this is not so. When using shunt coils simply connect as shown by the dotted lines and omit the push buttons.

Fig. 3 shows a method by which three to six 'phones can be used on four wires. Inasmuch as all bells ring in multiple, they should be of about the same resistance. Special "code" signals are generally used to call the desired party. Talking is also in multiple, so an impedance coil must be used. An impedance coil is nothing more or less than an electromagnet, in this case being about 14 ohms resistance and is used to keep the direct current from backing up out of the receivers.

The diagram at Fig. 4 depicts a common (multiple) talking, selective ringing cir-

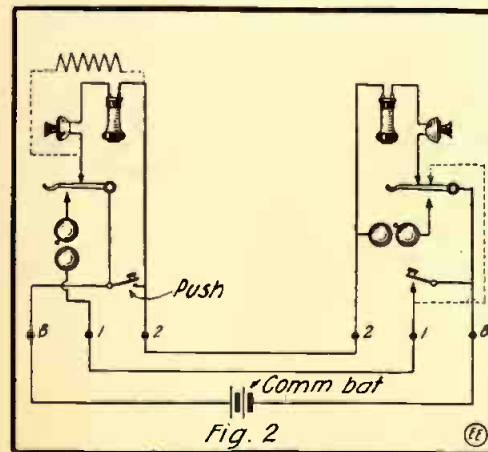

Fig. 2. Simple Battery Telephone System Utilizing Three Wires.

cuit, in which an impedance coil is also used. Any number of telephones can be used on this system, but only one pair at a time. There are always three more

wires than telephones and one section wire for each, which must be connected as shown.

The above are about all the connections for which any amateur electrician would find any use, but there are scores of others which would dazzle the eyes of many a young "hope."

In conclusion let me say that wherever a battery call system is used no induction coil is needed, as any direct current that can be used to ring a bell can most certainly be used for talking.

Contributed by LEWIS SCRIVEN.

THE CHEMISTRY OF THE STORAGE BATTERY.

In a brochure issued by the Titan Storage Battery Co., prepared by W. E. Winship, Ph.D., the chemistry of the lead storage battery is well expressed in brief, as follows: The active materials of the lead storage battery, spongy lead and lead peroxide, together with the sulphuric acid and the water of the electrolyte, enter directly into the chemical reaction which takes place on charge and discharge of the battery. (Note particularly that it is chemical energy that is stored in the battery and not electricity as such.)

On discharge, the spongy lead and lead peroxide are converted into lead sulphate at the expense of some of the sulphuric

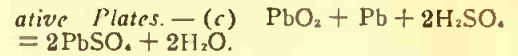

- H Hydrogen
- H₂O Water
- H₂SO₄ Sulphuric Acid
- Pb Spongy Lead
- PbO₂ Lead Peroxide

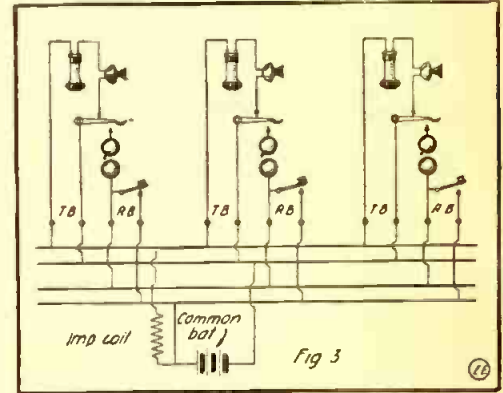

Fig. 3. Multiple Telephone System Using Common Talking and Ringing Wires.



These equations are the fundamental equations of the lead storage battery.

Equation (c), read from left to right, is the equation of discharge, and shows the change of spongy lead and lead peroxide on the negative and positive leads, respectively, into lead sulphate and the formation of water from hydrogen and oxygen of the electrolyte. Reading from right to left shows the reactions during charge.

The above reactions are those which normally take place. If impurities are present (Continued on page 733.)

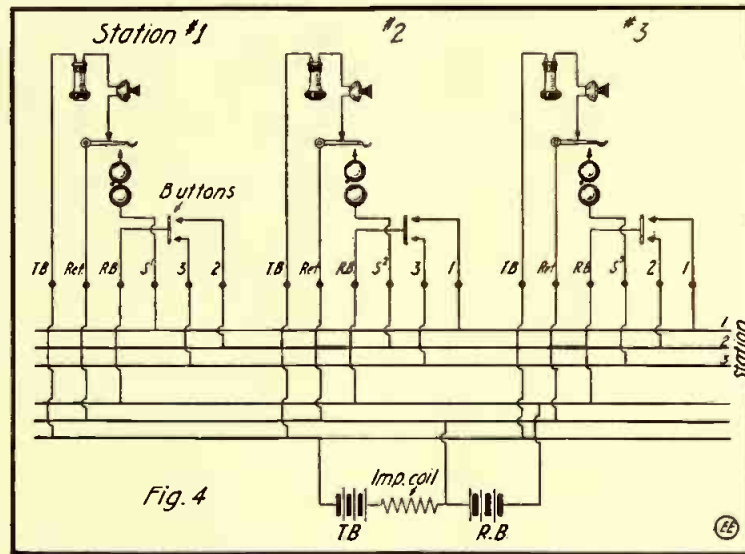

Fig. 4. Common Talking, Selective Ringing Telephone Hook-up.

acid, and in an amount almost exactly proportional to the ampere-hours discharge; while in addition some water is formed, which dilutes and decreases the specific gravity of the electrolyte. The original chemical energy is decreased by an amount equal to the electrical and heat energies developed, the latter being relatively small.

On charge the reverse action takes place. The lead sulphate previously formed on discharge being converted back to spongy lead in the negative plates, and to lead peroxide in the positive plates, a certain amount of water being chemically combined, in again forming the sulphuric acid and lead peroxide.

The lead storage battery, therefore, belongs to that class of batteries which are more or less reversible in their action. It is not completely reversible because of the heat generated and because of other actions described below.

The chemical reactions taking place may be expressed by the following equations:

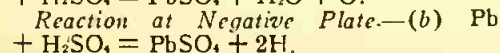
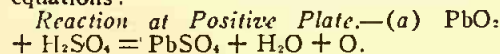

Combined Reaction at Positive and Neg-

EFFICIENT LEYDEN JAR RACK.

A neat Leyden jar rack is designed as shown in the diagram, so as to prevent the breaking of Leyden jars. The rack is made from spring brass or phosphor bronze stock 1/2 inch wide and 1-32 inch thick. The length will depend upon the size of the jar and the two strips are riveted together, as shown in the sketch. The end of the horizontal strip is bent at A, so that the tinfoil will not tear when putting the jar in the rack, or vice versa. A number

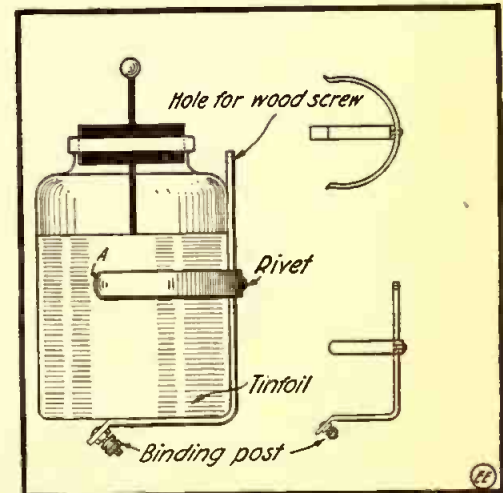

Simple Rack for Holding Leyden Jars.

of these racks may be fastened to the wall with suitable insulators behind them.

Contributed by FRANK HARAZIM.

HOW TO MAKE IT



This department will award the following monthly prizes: FIRST PRIZE, \$3.00; SECOND PRIZE, \$2.00; THIRD PRIZE, \$1.00. The idea of this department is to accomplish new things with old apparatus or old material, and for the most useful, practical and original idea submitted to the Editors of this department, a monthly series of prizes will be awarded. For the best ideas submitted a prize of \$3.00 will be given; for the second best idea a \$2.00 prize, and for the third best a prize of \$1.00. The article need not be very elaborate, and rough sketches are sufficient. We will make the mechanical drawings.

FIRST PRIZE \$3.00.

A SIMPLE A. C. CONVERTER.

For performing certain electrical experiments, or in operating certain electrical instruments, such as the Poulsen wireless tikker, telephone bell ringers, etc., it is necessary to use an alternating current. The instrument here described is quite simple in construction, yet capable of con-

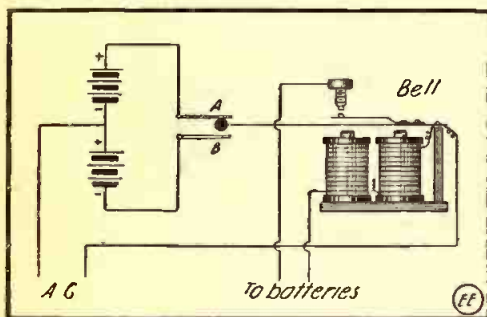

An A. C. Generator Constructed from Ordinary Bell.

verting a direct current into an alternating current (of square wave form) of quite high frequency if properly adjusted.

First procure an electric bell, remove the gong and straighten out the clapper, then fasten it upon a suitable base. Two thin brass strips A and B are now fastened in position, one on either side of the clapper, as illustrated. One brass strip connects to the positive terminal of one set of batteries, while the other brass strip connects to the negative terminal of another set of batteries. These contact strips should be quite close together so that the time interval taken for the striker arm to pass from one contact to the other will be short.

By referring to the wiring diagram it is understood that upon starting the bell the clapper will vibrate from A to B, causing the current to surge first from one set of batteries, then from the other; causing a direct current to be converted into an alternating current.

Contributed by

ARTHUR R. DARLING.

[Platinum, tungsten or silver contacts should be used on springs and clapper arm for best results.—Ed.]

REVERSING SWITCH FOR A D.C. MOTOR.

The following is a description of a re-

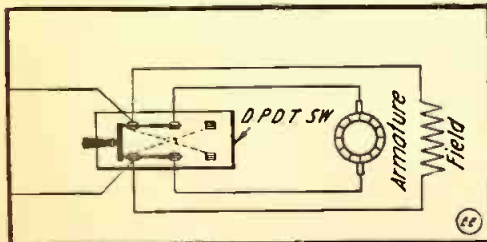

Reversing Switch for Shunt Wound D. C. Motor. versing switch for a direct current motor. Take any double-throw knife switch and connect the opposite contacts with well insulated wire. See diagram. The middle

SECOND PRIZE \$2.00.

A SIMPLE CIRCUIT TESTER.

The materials required for making this "tester" are a piece of zinc, a piece of blotter and a piece of copper, together with a set of telephone receivers, preferably of about 2,000 ohms resistance.

The dimensions of the zinc, copper and blotter sheets are optional with the builder, but I found that if the pieces are made an inch square the current developed in the battery will be sufficient for ordinary testing purposes. In making the battery it is best to solder a piece of wire onto the copper and zinc before assembling. It is assembled as follows: First saturate the blotter thoroughly with a 20 per cent. solution of chloride of zinc, next place the zinc square on one side of the blotter and the copper square on the other, and finally press the whole together. The battery is now completed, but its life will be prolonged if it is covered with paraffine to keep out the air.

When in use, one of the leads from the battery is attached to one of the tips of a set of 'phones; then if the other tip and terminal are attached to a closed circuit a loud click will be heard, but if the circuit is open there will be no sound. The "tester,"

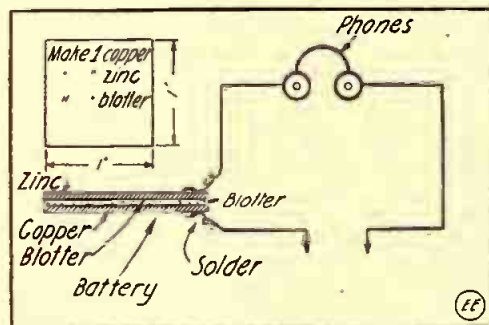

Handy Testing Outfit Utilizing 'Phone and Blotter Battery.

if properly made, will save much time and temper in ascertaining whether a circuit is closed or open.

Chloride of zinc is used because it is hygroscopic, i. e., it attracts water, thereby keeping moist for a long time. Besides, chloride of zinc does not attack zinc on open circuit.

Contributed by

J. WALLACE PECKHAM.

contacts are connected to the armature. The diagram is self-explanatory.

Contributed by EDW. CONNELLY.

A STATIC TRICK.

Static electricity around moving belts in some plants is so pronounced that it is necessary to provide special means for carrying it to the ground.

The following is an amusing trick: Hold the base of an electric light bulb close to a moving belt which is generating static. Now approach the innocent victim and offer him the lamp, of course extending the base. The moment he touches the base he

THIRD PRIZE \$1.00.

A MOVABLE CORE AMMETER.

This ammeter acts on the principle of the D'Arsonval instruments. An ordinary, permanent steel field magnet motor, of the type illustrated, is used. All that is necessary is to remove one connection and one brush from the commutator; then bind a

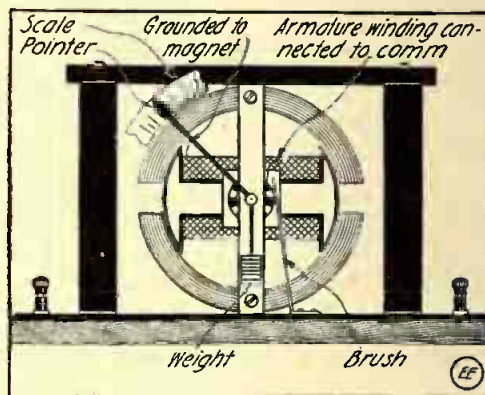

Converting a Small Motor Into an Ammeter.

wire around the latter to make it a conducting ring. Ground the connection which was removed to one of the magnet pillars, then connect the pillar to one binding post. The commutator is connected to the other. A weight on an arm is soldered to one projecting end of the shaft, as also a pointer. This latter is made by hammering flat a piece of No. 18 copper wire at one end; now cut the flattened part to a sharp point. A suitable scale is placed on the instrument which is calibrated by comparison with a standard ammeter.

Contributed by A. D. R. FRASER.

will receive a surprise in the nature of a harmless shock. The explanation is simple. The lamp acts as a condenser, the hand holding it being one plate and the filament the other.

Contributed by C. REX GILBERT.

RAPID LAMP AND FUSE TESTER.

Recently I had some fuse plugs and lamps to test, and I made a tester, of which I give herewith a sketch. The arrange-

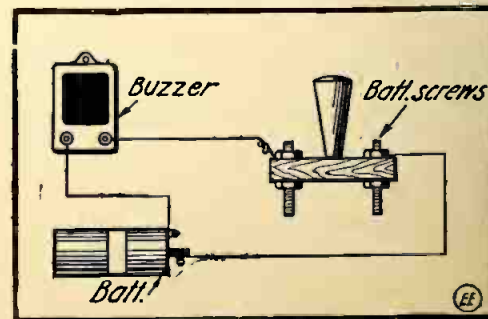

Rapid Cartridge Fuse Tester.

ment is so simple no description is considered necessary.

Contributed by H. S. BOUDEN.

CONVERTING OIL BICYCLE LAMP INTO ELECTRIC.

This is a description of an electric bicycle lamp made from an oil type lamp, as shown in the accompanying sketch.

The materials required are an old

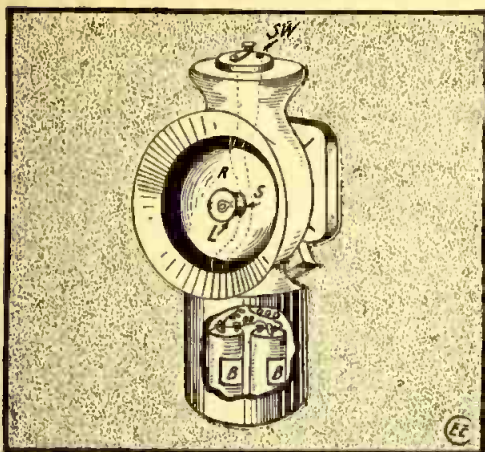

Converting Oil Bicycle Lamp Into Electric.

"Solar" lamp or any oil or gas lamp like that in sketch, a single point switch S W, flashlight batteries B, a miniature socket S, 2.5-volt bulb and some insulated wire. First remove the old burner from lamp, then remove the three small cells from the flashlight battery and cut the case to fit the cells; solder connections to the cells and place them in the bottom of the lamp. Mount the switch on top of lamp and fasten socket to the reflector R. Put the bulb in socket and connect up, as shown in diagram, and lamp is ready for use. It can be used as a bicycle lamp, or, also, it proves handy as a flashlight.

Contributed by CLIFF PINKERTON.

CLOTHES-PIN LAMP CORD ADJUSTER.

Many times, when working in a basement or other place, the electric lamp is in the way, and when a regular cord adjuster is not handy it is very troublesome to have to tie the lamp cord in a knot. The accompanying illustration shows a method that can always be resorted to. The holder shown is a common wood clothes-pin which holds the cord very

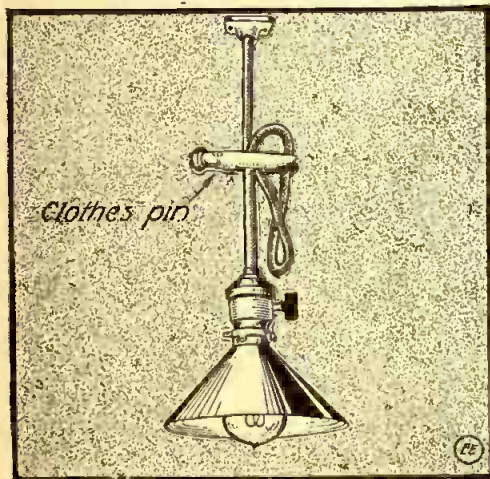

A Clothes-Pin Serves as a Lamp Cord Adjuster.

nicely in any desired position.

Contributed by WALTER FRANSEEN.

WIRE AND SHEET-METAL GAUGES.

There are at least eight wire and sheet-metal gauges in use in the United States at the present time, and this gives rise to much confusion and misunderstanding

STORING CHEMICALS.

The chemicals used in connection with electrical experiments are for the most part perfectly safe if handled with ordinary care. Acids should always be kept in glass stoppered bottles, since corks are rapidly eaten away to the detriment of the acid, as well as the cork. Dry crystals that are not deliquescent, that is, not absorbing moisture from the air, may be kept in cardboard boxes. Preserve or fruit jars often come in handy for the same purpose.

Deliquescent salts should be kept in glass bottles with wide mouths. Corked bottles that are not likely to be opened for some weeks or months may be made perfectly air tight by dipping the cork for a moment in melted paraffin wax contained in a shallow tin.

Contributed by H. J. GRAY.

A SMALL HAND-DRILL FOR 10 CENTS.

A very efficient hand-drill for light work can be made from a 10 cent egg-beater of the type shown in sketch No. 1. By modifying the egg-beater to look like sketch No. 2 and adding a chuck, made from a piece of tubing with two set screws in it, or a connector for wires, you will have an efficient,

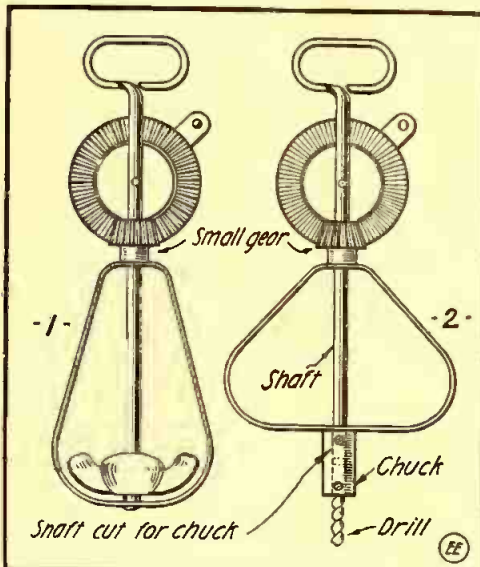

A Cheap Hand-Drill for the Experimenter Constructed from a 10-Cent Egg Beater.

small size hand-drill.

Contributed by H. KIHILSTROM.

among those not conversant with their use. The following are the principal gauges:

- Birmingham or Stubs' iron wire gauges.
- American or Brown & Sharp gauge.
- Roebing's and Washburn & Moon's gauge.
- Stubs' steel wire gauge.
- British Imperial Standard wire gauge. (Legal standard in Great Britain since March 1, 1884.)
- United States Standard gauge for sheet and plate iron and steel. (Legal standard in the United States since 1893, used in determining duties and taxes.)
- Morse drill and steel wire gauge.
- Edison or circular mil wire gauge used in electrical work.

These gauges have letters or numbers to correspond to the different sizes of wire or sheet-metal, but as these numbers do not correspond in actual measurement in the different systems, there is likely to be misunderstanding if care is not taken to designate which gauge you are using in making your measurement.

Take any number at random, say No. 5, and it has the following values for diameters or thickness on the different gauges reading in decimals of an inch, .23, .18194, .207, .204, .212, .219, .205; and No. 5 on the Edison gauge would be 70.72 mils diameter for electric wire.

The above comparisons are enough to show the necessity for care in the use of wire and sheet-metal gauges. If you wish to get from the dealer just the size of wire you want, and you have a gauge at hand which corresponds to the size, be sure and name the kind of gauge, as for example, "No. 5 measured by American or Brown & Sharp gauge."

If you have no gauge but have some of the wire

the lamp is supported in a miniature porcelain socket, as usual. The switch is composed of a piece of spring brass adjacent to one end of the carrying handle, as ob-

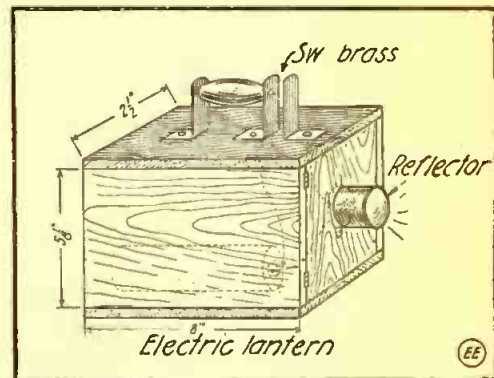

Box Type Electric Lantern Adapted for Use with Standard Dry Cells.

served in the illustration, so that the thumb can press this spring against one of the handle ends very easily and in this way close the battery circuit.

Contributed by ROBERT FORNEY.

such as you want, send the dealer a sample with your order.

If you attempt to measure the wire or sheet-metal with such instruments as you have at hand you probably will have difficulty in doing so as some of the sizes have no variation until the fourth decimal place is reached.—Gas Review.

and sometimes forget to turn off the battery when through with it, with the result that the batteries and light soon become worn out. They will probably find a ready use for this device of mine, which never "forgets," as it works automatically. As can be seen from the drawings, when

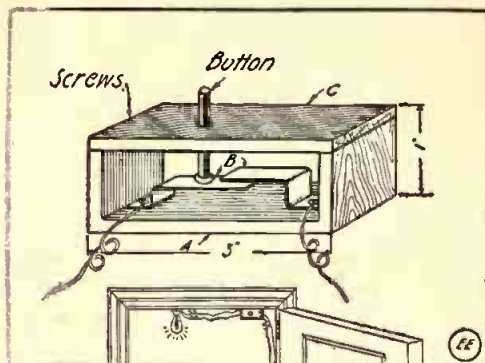

Automatic Closet Switch Extinguishes Lamp When Door Is Closed.

the door of the closet is open (there being no pressure on the button) the brass strips come into contact, thus closing the circuit. The reverse is the case, however, when the door is closed. Thus opening and closing the door makes and breaks the circuit, respectively.

To make the switch cut or saw a piece of dry wood into the shape shown at A. Then bend and fasten on it two springy brass strips B, with two screws and nuts, which serve the double purpose of holding the strips in place and acting as binding screws for battery wires. A cross piece C, with a hole in the middle for button, is then screwed or glued into position. Care should be taken that the button connects with the under brass strip and not the upper, as this is the important feature of the device. Lower figure shows the switch screwed in position on the top jamb. If a neat appearance is desired cover with shellac or varnish.

Contributed by JOHN T. DWYER.

AN INTERESTING A.C. EXPERIMENT.

The following is a very interesting experiment in electrical phenomena, which will undoubtedly interest some of your readers, and those who are interested in wireless already have the necessary apparatus for performing this experiment at hand.

A condenser and a variable reactance are connected in multiple with ammeters A₁ and A₂, as shown in diagram. The reactance should be varied until ammeter A has reached its maximum reading; such a condition is called electrical resonance. It will be noted that the sum of the readings A₁ and A₂ will be very much greater than A, which is apparently contrary to the laws which govern a divided circuit, as the am-

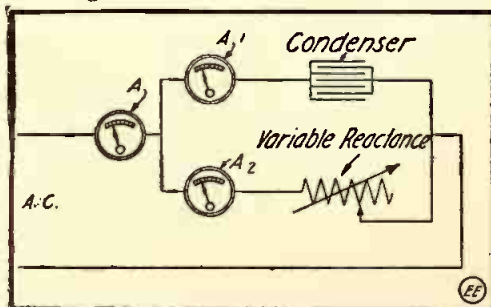

Interesting Capacity and Inductance Effect on A. C. Circuits.

meters indicate that more current is flowing in the divided circuits than is actually entering them. The theory for the above can be found in any reputable text book on alternating currents under the head of electrical resonance.

This experiment, when carefully reasoned out, should prove very amazing as well as instructive to the embryo electrician.

Contributed by H. C. YEATON.

AN EFFICIENT BATTERY TESTER.

This battery tester, although it does not tell the exact number of volts and amperes in a battery, will tell roughly the amount of energy left in it.

Procure a piece of wood 2½ inches square and ½ inch thick and put a ⅛-inch bevel on it. Then find the center of it and bore a ⅝- inch hole. Procure a small straight bottle, such as cheap colognes come in, and fasten it securely in the hole

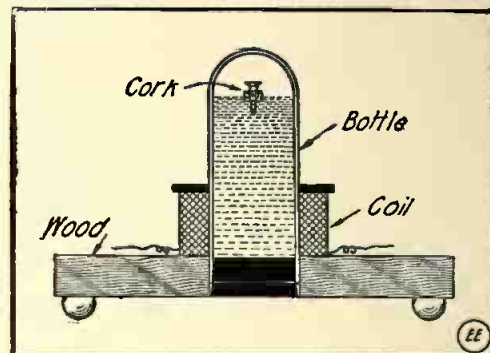

The Magnet Coil Attracts the Cork and Iron Screw, Forming a Useful Battery Gauge.

by wrapping paper around it and gluing it so that the neck of the bottle is flush with the bottom of the wood. Glue a cardboard disc in the center of the bottle and let it dry securely. Then take a ⅝- inch wire nail and a small bit of cork. File off the nail and cut the cork so that there is just enough cork to float the nail in water. Then measure off about 20 feet of No. 20 magnet wire and wind it between the wood and the disc of cardboard so as to form an electro-magnet. Next fill the bottle with water and after dipping the cork in shellac, seal the bottle. By putting one wire on the carbon and the other on the zinc, the cork will go down and will rise as soon as the power is shut off. The harder and faster it goes down, the more current the battery contains. On a very weak battery it will simply move on the surface.

Contributed by

WILLIAM BINGHAM.

SIMPLE FORM OF RESISTANCE.

The construction of a simple form of resistance is described as follows: (See drawing) C is a length of carbon rod,

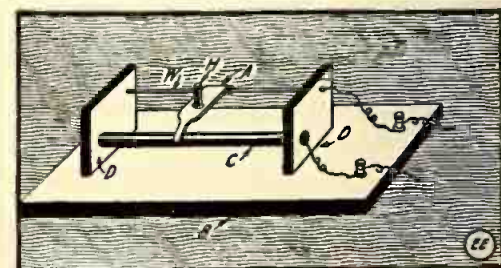

Rheostat Made from Arc Lamp Carbon and Slider.

such as used in motion picture machines. W represents a length of No. 4 copper wire. A is a piece of tapering sheet brass, bent into cylindrical form at the wide end to slide along wires W. H is a wooden knob. D are wooden blocks; B the base with terminals. By sliding A to the left or right one obtains more or less resistance respectively.

Contributed by

WM. MALM.

Send us a brief description and pencil sketch of your latest stunt. We pay for them.

A CHEAP CURRENT REDUCER.

Here is a description of a current reducer with which I am operating my 1-inch coil on 110 volts alternating current. I am

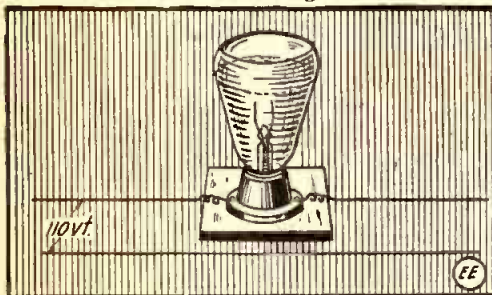

Cheap Current Reducer Made from Old Lamp Bulb.

using two of them in series and they give my coil a fine pitch by stretching a rubber band across the vibrator: Take a common burned-out lamp bulb and with a glass cutter cut off the top. File the top smooth, cut off wires about 1½ inches from bottom and fill with water. If not enough current passes through, add a little common salt to the water.

Contributed by G. C. MILLER.

AUTOMATIC ELECTRIC DOOR SWITCH.

Many electrical experimenters have lighted circuits for illuminating dark closets

Wrinkles Recipes Formulas

EDITED BY S. GERNSBACK

Under this heading we are publishing every month useful information in Mechanics, Electricity and Chemistry. We shall be pleased, of course, to have our readers send us any recipes, formulas, wrinkles, new ideas, etc., useful to the experimenter, which will be duly paid for, upon publication, if acceptable.

FORMULA NO. 20.

Extracts.

Cocoa.—Dissolve 1 lb. of *Chocolate* in 1 qt. of *Boiling Water*, let it cool, take out the *Cocoa Butter* and add to it 4 oz. of *Glycerine* and bottle.

Compound Coffee (for Dispensing).—8 oz. best (ground) *Java Coffee*; 2 drm. sliced *Vanilla Bean*; add diluted *Alcohol* in sufficient quantity.

Plain Coffee Extract.—Pour upon 1 lb. of best fresh roasted *Coffee* 1 qt. of *Cold Water*, heat gently for half an hour then let it come to a boil, cool for 2 hours, strain and add 4 oz. of *Glycerine*.

Ginger (for dispensing).—Take 1½ pt. of *Fluid Extract of Ginger*, 3 pts. of *Water*, 3 oz. of *Carbonate of Magnesia*; mix, shake often for 24 hours; filter, evaporate to ¾ pt. and add ¾ pt. of *Alcohol*.

Mead.—Oil of *Lemon*, 1 oz.; Oil of *Cloves*, 2 drm.; Oil of *Cinnamon*, 2 drm.; Oil of *Nutmeg*, 1 drm.; Oil of *Allspice*, 30 drops; Oil of *Sassafras*, 40 drops; Oil of *Ginger*, 1 drm.

Cut the Oils with *Pumice* and *Sugar*; dissolve in 16 or 32 oz. of *Alcohol*.

Add gradually an equal quantity of *Water*; clarify.

Liebig's Meat Extract.—1 oz. *Lean Meat*, very fresh, chopped very small; add 8 oz. *Cold Water*; shake well together for 10 minutes; heat gradually to boiling, let simmer gently for a few minutes, strain through a hair sieve while still hot; evaporate to a soft substance.

Sarsaparilla Extract.—Take 16 oz. *Jamaica Sarsaparilla*, cut transversely, 280 oz. *Distilled Water* (160° F.), macerate in half the water for 6 hours and decant the liquor. Digest the residue in the remainder of the water for six hours more, mix the liquors, press and filter.

Evaporate by a water bath to 7 oz. when cold, add 1 oz. of *Rectified Spirit*.

Peach.—3 drm. Oil of *Almonds*, 3 drm Oil of *Pineapple*, 3 drm. *Tartaric Acid*, 1½ pt. of *Alcohol*, 80°.

Pineapple.—2 oz. of *Pineapple Essence*, 1 oz. of *Citric Acid*, 2 pts. of *Alcohol*, 80°.

Strawberry.—1½ oz. of *Pineapple Oil*, ¼ oz. of *Tincture of Orris*, ¼ oz. of *Tartaric Acid*, 1½ pts. of *Alcohol*, 80°.

S. G.

Did you ever stop to think that for every carbon lamp in your chandelier you may have three times the candlepower at the same cost for current by substituting tungsten lamps.

When you think of a new idea, write it down. Otherwise you will forget it.

A GASOLINE TORCH FOR THE EXPERIMENTER.

A very handy gasoline torch for the experimenter's laboratory can be successfully and easily built. This torch will develop a considerable amount of heat, which is frequently needed for certain experiments. The burner is made from a piece of brass tube, A, as illustrated in illustration. This should be ½ inch in diameter and 2½ inches long, plugged up at both ends, one end being drilled and reamed out to 5-16 inch. Three rows of holes 1-16 inch in diameter are next drilled in the tube as depicted. One row is drilled to come directly on top and the other two at about 45° from the vertical. It is then fitted to a sheet steel base, B, by means of the clips, C, C. A piece of ⅛-inch copper pipe, P, is next coiled around the brass tube, A, to form the vaporizing coil. This coil should have a diameter of about 1 inch. One end of the copper tube is bent around so it will point directly into the reamed out hole in the end of the brass tube, A. A nipple, N, is made by drilling a ⅛-inch hole half way through a piece of brass, topped to fit the ⅛-inch hole. A 1-64-inch hole is then drilled through the remaining part of the nipple. The other end of the copper tube is connected to the supply tank.

The distance between the nipple, N, and the end of the tube, A, should be only 5-16 inch. The supply tank can be made from a brass tube 3 inches in diameter and 6 inches long, with the ends sealed by soldering on two end pieces of the same material. A small cock is provided, which is directly connected to the torch. A small

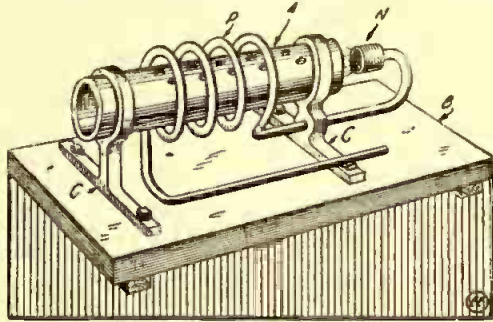

A Home-Made Gasoline Torch.

hole is made on the top of the tank to allow air entering the interior, in order to force the gasoline to the burner. Care should be taken in handling the gasoline, as it is very inflammable. It will be found that the torch will produce a hotter flame when the copper coil is quite hot; this is due to the fact that the gasoline is more readily vaporized and consequently a better mixture is produced.

In order to start this device vaporizing it is necessary at first to warm the coil by means of a match, or with a little gasoline, ignited under the worm.

Contributed by LOUIS WEISS.

CHEMICAL EXPERIMENTS.

By W. A. Talmage.

THE POPULAR WINE AND WATER TRICK.

Obtain a small quantity of phenolphthalein from your chemist or druggist in powder form. Dissolve it in a small bottle and keep well corked. When ready for the trick (before the performance) place some of this solution in a small crystal or porcelain pitcher and partly fill with clear water, then prepare four wine glasses or small tumblers as follows: No. 1 glass with about a teaspoonful of ammonia. No. 2 glass clear. No. 3 glass with a teaspoonful of ammonia, and No. 4 glass with two teaspoonfuls of acetic acid.

More glasses and chemicals may be used if desired, but must be prepared as above. To perform the trick pour from pitcher into glass No. 1 and we have wine, then into glass No. 2 we have water, and glass No. 3 we have wine, then glass No. 4 we have water; pour back glasses 1, 2 and 3 into pitcher and then fill the three glasses with wine from the pitcher, now pour all four glasses back and then fill them with water from the pitcher.

A little practise before you attempt this with your friends will enable you to handle glasses and pitcher skilfully. Try to cover the solution in glass No. 4 with your hand when pouring into it for the first time.

CHEMICAL COLOR CHANGES.

The following chemicals should be dissolved separately in individual bottles, labeled properly and kept tightly corked:

No. 1—Permanganate of potash, ½ dram; water, 4 ounces.

No. 2—Caustic soda or potash, 1 dram; water 4 ounces.

No. 3—Hyposulphite of soda (hypo), 2 drams; water, 4 ounces.

No. 4—Bichloride of mercury (poison), ½ dram; water, 2 ounces.

(Be sure and label bottle poison.)

No. 5—Sulphate of iron, ½ ounce; water, 4 ounces.

No. 6—Red prussiate potash, ½ dram; water, 2 ounces.

No. 7—Oil of tartar, this is made as follows: Carbonate of soda or common washing soda, ½ ounce; water, 4 ounces.

No. 8—Acetic acid (clear acid).

The above chemicals are all used in photography and may be purchased of any photo dealer.

In a tumbler containing a small quantity of water place enough No. 1 solution to give a nice wine color, then add about a half teaspoonful of No. 2 solution, this will slightly redden the No. 1 solution; now place a few drops of No. 3 solution, this will change to green; add a small quantity of No. 8, you will observe this to turn brown and then clear itself. Rinse tumbler out thoroughly.

Put about ten drops of No. 4 in half tumbler water, add a small quantity of No. 7, this changes to a deep orange color; now add a small quantity of No. 8, immediately clears itself. Remember that No. 4 is poison and should be handled with extreme care. Rinse glass thoroughly.

A small quantity of No. 5 in a half tumbler of water will be a clear solution and a small quantity of No. 6 in half tumbler of water will be clear; add both together and you will have a deep navy blue.

By further experimenting with above chemicals you will be able to perform many other changes.

MYSTERIOUS SMOKE TRICK.

Place a small quantity of ammonia in a tumbler and upon a small piece of clear glass place a few drops of muriatic acid. Tell one of your friends that you can find out whether he is an excessive smoker or not, and have him place his thumb on the under side of the sheet glass and carefully turn it over on top of the tumbler with his thumb still in position; the result will be an excessive amount of smoke issuing apparently from his thumb.

MYSTERIOUS FIRE.

A small quantity of chlorate of potash mixed with the same amount of sugar placed on a piece of tin or stone and then touched with a stick dipped in sulphuric acid will instantly burst into a bright white flame. If a small quantity of strontium nitrate is mixed with this the flame will be red instead of white, or if the same amount of barium nitrate is mixed instead of strontium the flame will be green.

WITH THE AMATEURS

Our Amateur Radio Station Contest is open to all readers, whether subscribers or not. The photos are judged for best arrangement and efficiency of the apparatus. To increase the interest of this department we make it a rule not to publish photos of stations unaccompanied by that of the owner. Dark photos preferred to light toned ones. We pay each month \$3.00 prize for the best photo. Make your description brief. Address the Editor.

AMATEUR RADIO STATION CONTEST.

Monthly Prize, \$3.00.

This month's prize winner.

C. HERSCHEL WOODRUFF'S RADIO STATION.

A short time ago a ½-K. W. "Hytone Set" was left in my care with permission to use it on my aerial. I tried a little experiment which cleared up the trouble. This is the method to follow: First, take a piece of lamp cord, which is made of a number of small wires, and ground the earth side of the oscillation transformer. Then make a small gap of about ½ inch, using one strand of the lamp cord as one electrode. At first you may get a heavy, thick spark when the key is pressed, which



Lower Figure on Mast is C. H. Woodruff, Owner of Station Shown at Right.

would not melt the wire, but by changing the tuning you will be able to get a spark which will melt a No. 10 copper wire.

With this arrangement I was able to "raise" a dozen amateurs. The range covered Cincinnati, St. Marys, Lima, Tiffin, Mt. Gilead, Mt. Vernon, Springfield and Fort Wayne, Ind. (9.P.C.).

The aerial was 90 feet long, 4 wires spaced 2 feet apart, 65 feet high. In the picture of my mast, the lower figure is myself, while the one above is a friend of mine (8.T.T.). The transmitter is ¼ K. W. with oil condenser, rotary gap and oscillation transformer. The gap is enclosed in a box just above the oscillation transformer.

The receiving set is of my own construction, as is the transmitter, and consists of 4,000 meter loose coupler, audion detector and 'phones. My set is capable of sending 40 miles and covers from 25 to 35 miles regularly. The receiving outfit has a range which covers Tampa, Fla., Miami, Fla., Key West, Galveston, Texas and Port Arthur.

C. HERSCHEL WOODRUFF.

Columbus, O.

HAROLD BENNETT'S RADIO STATION.

Herewith I present a description and photograph of my wireless station for competition in your Amateur Wireless Station



Wireless Station of Harold Bennett.

contest. All of my instruments were purchased and mounted in cabinets. On the left of the illustration will be observed the receiving set, which is composed of an Arlington type D transformer, and detector (on top of cabinet). On the side of the case is a loading coil, variable fixed condenser and receiver block. My receivers are 2,000-ohm type of the Murdock make. The sending set consists of a spark coil used in connection with a separate interrupter and condenser. On top of the cabinet is a spark gap and a large helix.

I can transmit 13 miles and receive 1,500 miles, hearing Arlington and several other high-power stations. I would be glad to hear from any amateurs, or exchange photographs of my set with them.

Clarinda, Ia. HAROLD BENNETT.

LONG DISTANCE RADIO STATION OF C. L. TODD.

Herewith is a photograph of my radio station, the description of which is as follows: The transmitter consists of a "Blitzen" ½-K. W. transformer with Clapp-Eastham condenser, Murdock rotary gap and a "jigger" (oscillation transformer). Sending range approximately 300 miles. QRK at 2CE and QSA at 8LQ. Marble switchboard contains meters and antenna switch.

The receptor is mounted in and on a mahogany cabinet fitted with hard rubber



Conway L. Todd Receiving Radio Messages.

face. The instruments contained thereon are: Two Clapp-Eastham "Cambridge" variable condensers, their type "D" tuner, De Forest audion and loading induc-

tances controlled by telephone cam switches. Receiving range about 2,500 miles.

The antenna is triangular, 30 feet on a side, constructed of stranded phosphor-bronze wire No. 10. It is 50 feet in height and very well insulated.

I would be glad to hear from any amateur within range. Working hours from 7 to 11 p. m. Call 8 A. D. E.

CONWAY L. TODD.

Rochester, N. Y.

PORTABLE WIRELESS SET OF J. F. RIEHLE.

The radio set here depicted is a compact, portable one, which can be placed on

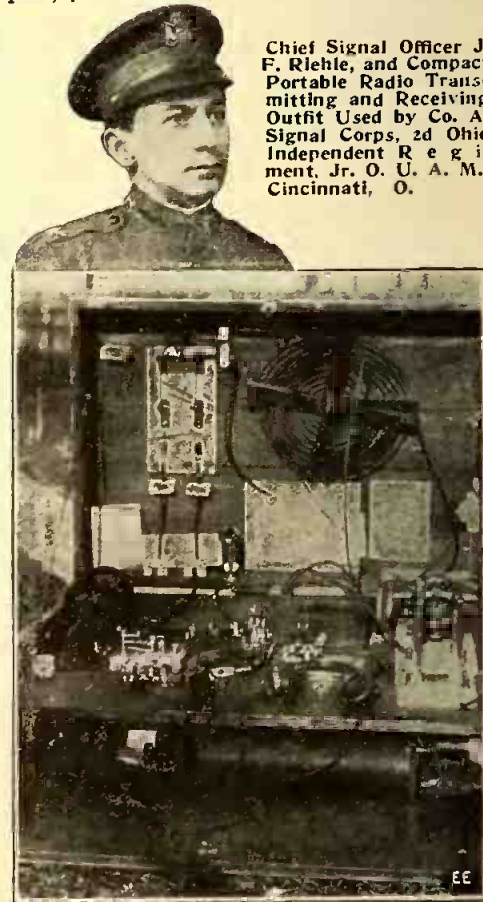

Chief Signal Officer J. F. Riehle, and Compact Portable Radio Transmitting and Receiving Outfit Used by Co. A, Signal Corps, 2d Ohio Independent Regiment, Jr. O. U. A. M., Cincinnati, O.

the back of a Ford runabout. It consists of a ½-K. W. 110-volt transformer, a 1-inch spark coil, a rotary and stationary spark gap mounted on marble, 5 moulded condensers for sending, 2 detectors, 2 variable condensers, 1 for primary and 1 for secondary of loose coupler, a large loading coil, fixed condenser and 2 1,000-ohm 'phones, also a large oscillation transformer, aerial switch and 2 sending keys, 1 for alternating current and 1 for spark coil on battery. The set can be used on either 110-volt 60-cycle alternating current or 6-volt storage battery, only two connections having to be changed to shift from one to the other. The spark gap can also be converted from rotary to stationary by two changes in the posts of gap.

This outfit was used by Co. A, Signal

Corps of the 2d Ohio Independent Regiment Jr. O. U. A. M. (Incorporated) at Coney Island during a sham battle. The time required for setting up the collapsible poles, running the aerial and putting the entire set into operation was but 5 minutes. The poles are 50 feet high and the aerial is composed of No. 10 copper wires, each 85 feet long. I have been able to receive all of the coast stations, including Key West, but am not quite sure about the sending range, but I should think it would be somewhere around 100 miles. I am the chief signal officer of the Signal Corps, also an electrical inspector with the Cincinnati Fire Prevention Bureau, and therefore keep in touch with nearly all the amateur operators in my vicinity. J. F. RIEHLE.
Cincinnati, O.

ROBERT WITSCHEN'S WIRELESS OUTFIT.

Herewith I am submitting a photograph

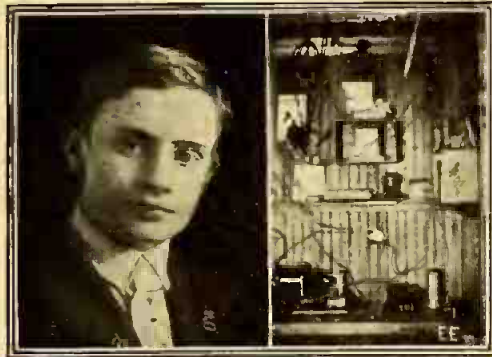

Master Robert Witschen and His Neat Radio Station.

and description of my station. Not all of

the apparatus that I own can be seen in this illustration. On the left you will observe my receiving outfit, which comprises a loose coupler, fixed condenser, 1,000 ohm single head-set and a Crystaloi detector. The sending outfit consists of a 1/2-inch coil, a home-made spark gap and a fixed condenser. The aerial has five wires on nine-foot spreaders and is 48 feet long and 48 feet high.

I should like to get acquainted with other amateurs within 60 miles of my station. My age is 15 years.

ROBERT WITSCHEN.

St. Cloud, Minn.

WEATHER FORECASTS BY WIRELESS.

A new scheme about to be inaugurated by the Weather Bureau will be the sending of weather reports to farmers by wireless. This experiment is to be tried out in Illinois and, if successful, the system will be spread to other States which request it. The messages will be transmitted at the rate of 10 or 12 words a minute to accommodate amateur operators who are not usually proficient enough to receive faster. An approved card has been provided whereon the receiving wireless operator copies the forecast message and posts it for the benefit of the public. Any farmer with an inexpensive receiving apparatus and a knowledge of the Morse code can obtain these forecasts by "listening in" while the station is sending them out.

RADIO STATION OF K. KERMET KRAMER.

The accompanying illustration is of my wireless station. The aerial is 32 feet high at one end and 40 feet at the other, and

is composed of two copper wires 100 feet long. The receiving set consists of an Amco loose coupler, home-made loading



coil, Brandes' 2,000 ohm 'phones, Crystaloi detector, fixed and variable condensers and a buzzer test. The transmitting set is mounted in and on a mahogany finished box. It consists of a Mesco helix and key, spark gap, Leyden jar and auto spark coil. I can receive N. A. A., N. A. M. and many other stations very loud and clear. The sending set has a range of about two to three miles. K. KERMET KRAMER.
Elizabeth City, N. C.

Wireless equipment and a heliograph have been combined by a New York inventor in portable signaling apparatus for use on railroads or at sea.

Amateur News

Radio Club of America.

The December meeting of the Radio Club of America was held on Saturday evening, Dec. 4, in Fayerweather Hall, Columbia University.

L. J. Lesh, of the Aero Club of America, presented a paper on "The Development of Radio Sets for Aeroplanes." Mr. Lesh is the foremost worker in this field of radio work. The paper was plentifully illustrated by lantern slides of the recent tests conducted by Mr. Lesh and Emil J. Simon at the Curtis laboratories at Hammondsport, N. Y. Results of many interesting experiments with the "aerofan" were discussed.

The discussion following the paper was participated in by Fritz Lowenstein, E. J. Simon, L. G. Pacent, Paul F. Godley, Walter S. Lemmon and Ernest Amy.

The Cape May County Radio Association.

The Cape May County Radio Association, of Wildwood, N. J., which was organized in May, 1915, would like to hear from other clubs and amateurs within a radius of 100 miles.

The officers are: Edwin L. Chalmers, president; Edward N. E. Schlichting, secretary; Richard J. Anderson, treasurer.

All of the officers are licensed and have up-to-date sets.

Bradentown, Fla., Radio Club.

The amateurs of Bradentown, Fla., have organized under the name of the Bradentown Radio Club, with ten members at present. Meetings are held weekly in a small building which has been converted into a club room. The club has purchased a receiving set and intends to add sending apparatus as soon as possible. The club is anxious to get in touch with other amateurs or clubs in the State through its secretary, Hughson Hurlbeaus, 439 Main street, Bradentown, Fla.

Amateur Radio Association of New Bedford, Mass.

The first meeting of the Amateur Radio Association of New Bedford, Mass., which was held at Mr. H. Johnson's station on Oct. 27, at 240 Chancery St., was a great success. The officers, elected for a term of three months, were as follows: President, Antone Sylvia; Financial Secretary, Horace Johnson; Station Inspector, Ralph E. Taylor. A committee was appointed to draw up a constitution for the association. The object of the association

among amateurs is to develop a more extensive knowledge of wireless telegraphy. The members who attended the first meeting were Antone Sylvia, Horace Johnson, Henry Ackerman, Ralph E. Taylor, Frank Allen, William Pinnington, John W. Callaghan, Douglas Tripp, Stanley Wood and Anthony Hayden.

New Radio Club Organized at Rockaway Beach, N. Y.

Local amateurs have succeeded at last in organizing a radio club called the "Rockaway Radio Club" for the purpose of bringing together the many amateurs in this vicinity. Two successful and interesting meetings have been held in the club rooms at No. 296 Washington Ave., Rockaway Beach, L. I., the second of which resulted in a decided increase in membership. The following officers were elected: President, H. Conway; Vice-President, R. Richter; Treasurer, J. V. Byrue; Recording Secretary, Lewis Wagerer; Corresponding Secretary, H. Friegerlin; Sergeant-at-Arms, L. Anderson.

For the convenience of the members a library has been established and E. Richter and W. Byrue were appointed librarians to take charge of same. Address all communications to Rockaway Radio Club, 296 Washington Ave., Rockaway Beach, N. Y.

Election of Officers of the Arlington Radio Club.

At a recent meeting of the Arlington Radio Club

of Arlington High School (Mass.), the following officers were elected: W. C. Clark, president; Elliott Perkins, vice-president; Harold O. Bixby, secretary and treasurer. The club has a large membership and will soon have both efficient transmitting and receiving sets in operation.

New Radio Club in Akron, Ohio.

The Akron Radio Club, of Akron, Ohio, was recently organized and the following officers were elected: Jack Gritton, president; Donald Hoffman, vice-president; Clarence W. Brown, secretary; Virgil Baysinger, treasurer; Darley Thurmes, exchange manager; Roland Palmer, electrician, and Howard Myers, inspector. The club has twenty-two members at present. Meetings are held weekly at the president's home. The club members would like to communicate with other radio clubs. Address all communications to Clarence W. Brown, R. F. D. No. 25, Akron, Ohio.

Association at Pensacola, Fla.

There was organized in Pensacola, Fla., on the first of January, 1916, a radio association which will be for the benefit of the amateurs of United States and Canada. It will be operated on a new basis which will be more of a help to the amateur and laymen than any other association in the country.

All amateurs interested in this movement please write for full information to T. H. Moore, Jr., 321 North Spring street, Pensacola, Fla.

RADIO CLUBS ATTENTION!

We are always pleased to hear from young Edisons and Radio Clubs. Send a write-up of your Club with photos of members and apparatus to-day to: Editor "Amateur Gossip" Section, The Electrical Experimenter, 233 Fulton St., New York City.

The Carrollton Radio Inter-Communication Club.

The Carrollton Wireless Club was reorganized in the laboratory of the public school at Carrollton, Ill., Nov. 24, as the Carrollton Radio Intercommunication Club. The following officers were elected: Ward Dickson, president; David Roberts, vice-president; Stuart W. Pierson, secretary and chief operator; Owen Jarboe, treasurer. The purpose of the organization is to regulate the radio work in Carrollton, to make the members proficient operators and to study the art of radio communication. The club will meet every other Tuesday. At each meeting papers pertaining to some special topic are read and then discussed. The secretary would like to hear from any wishing to get in communication with Carrollton, Ill.

LATEST PATENTS

Resonating Relay.

(No. 1,166,951; issued to Hans von Kramer and Gilbert Kapp.)

This device involves valuable factors controlling the movement of contacting or circuit-closing vanes.

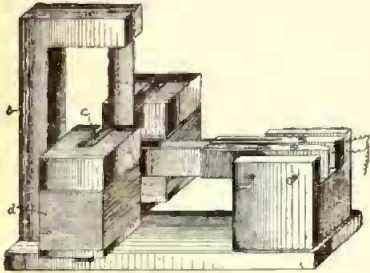

These factors may be varied in different ways and a relay can be tuned to respond to any desired frequency within certain limits. This device is capable of being operated by very feeble alternating currents and when so actuated can close the circuit in the usual manner. The magnetic circuit is permanently magnetized.

Telephone Attachment.

(No. 1,163,326; issued to David Y. Donaldson.)

An improved form of telephone desk set whereby the transmitter and receiver are mounted on a re-

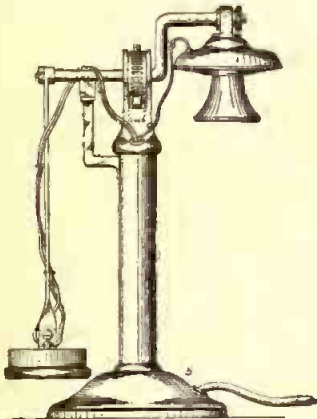

volving arm. Normally the transmitter and receiver hang downward so as to be dust and germ proof. The receiver is also mounted on a rigid arm, so as to be held in the proper position when the apparatus is revolved for talking, thus doing away with the task of holding the receiver to the ear.

An Elevator Door Light.

(No. 1,164,301; issued to Charles E. Moore, assignor to Elevator Supply & Repair Co.)

A threshold illuminator for elevators, etc., whereby the floor at the opening of the doorway is lighted to

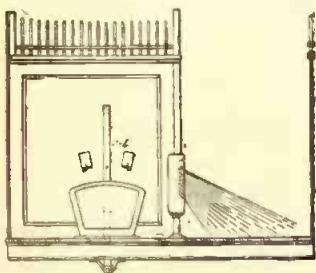

prevent persons from tripping. Whenever the car stops, the lamps, which are arranged in a special reflector as observed, are switched on automatically and off again as the car proceeds on its journey. This

arrangement is now in use in some of the largest office buildings where it has proved invaluable in the prevention of accidents.

Quenched Spark Gap.

(No. 1,163,568; issued to Frederick G. Simpson.)

This patent relates to the design of quenched spark gap units intended to be interchangeable and comprises a special insulation ring into which are threaded the metal sparking surfaces of substantial size. The gap is thus particularly rugged. Again the various parts are made of materials having nearly the same coefficient of expansion, so that no variation of the spark gap length can occur due to heating of same.

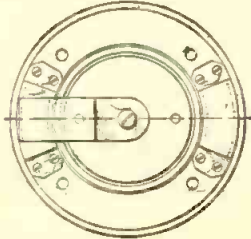

Electric Heat-Storage System.

(No. 1,161,748; issued to William Stauley, assignor to General Electric Company.)

This invention relates to an improved method of storing heat electrically and pertains especially to the arrangement and selection of the heat absorbing materials. A metal container 10, is placed in a quantity of heat storing material 15 (electric furnace sublimation products containing silicon, for instance). Means are provided in the design suggested, whereby the heat developed is automatically regulated according to the temperature of the heat storage materials, as

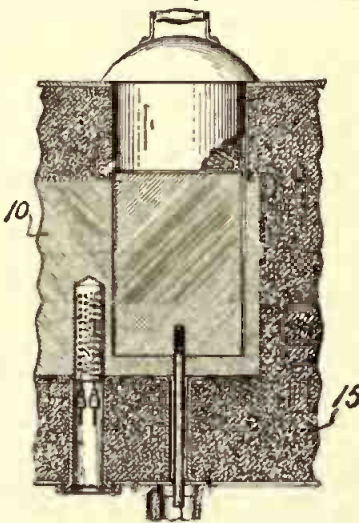

by using iron wire in the electric resistor.

A Liquid Rheostat.

(No. 1,161,746; issued to George Squire, assignor to General Electric Co.)

The inventor of this rheostat of the liquid type, endeavors to improve the efficiency of the same, especially as to the proper cooling of the fixed electrodes. A liquid is introduced through an upper nozzle 1, the discharging orifice of which may be changed as desired by swinging the segmental apron 5, upward

on its axis 6. In this manner the liquid carrying current is constantly flowing past the fixed electrodes and has but little chance to heat, besides cooling the tips of these electrodes in a very efficient manner.

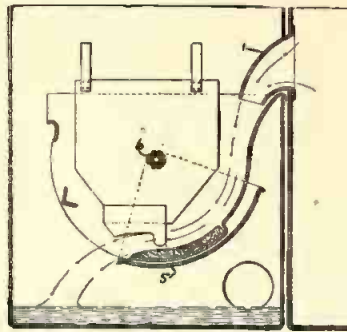

Quenched Spark Cap.

(No. 1,161,520; issued to Richard Pfund.)

A quenched spark gap improvement intended to do away with the thin and delicate insulating washers now in vogue. In this design a heavy insulating washer 5 is used,

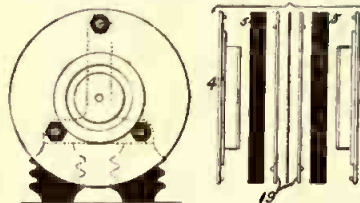

also two metal plates 19, and between these are placed a metal spacing washer 7. Cooling vanes of metal are placed between every gap or against plates 4 and 4, for instance. It will be seen that this design offers many advantages over that ordinarily in use nowadays.

Telephone Receiver.

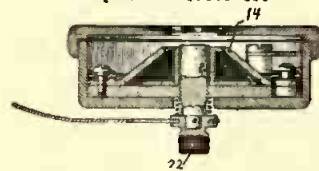

(No. 1,166,152; issued to Thomas Rhodus, assignor to The Magniphone Co.)

This is an improvement on the electromagnetic type of telephone receiver, designed so that the magnet coil will occupy the minimum amount of space and thus provide as large a (sound) resonance chamber within the receiver as possible. The yoke of the electro-magnet is in the shape of an iron cone 14. The center core may have its air gap before the diaphragm varied by means of an adjusting nut 22. The spiral spring under the nut takes up any lost motion in the core thread.

Telephone Synchronizing Device.

(No. 1,160,356; issued to Arthur H. Adams, assignor to Western Electric Company.)

This device is intended for the purpose of simplifying the synchro-

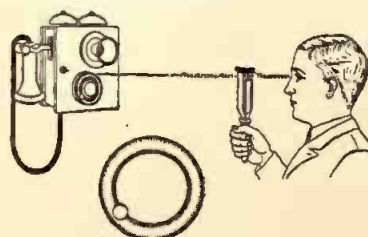

nization of automatic telephone calling discs. The disc itself, or a paper template fitting over same, is

provided with two circles composed of black points. When these are viewed through the tuning fork synchroscope as perceived, they appear to be stationary if the speed of the disc is correct.

It will be obvious that for the tuning fork shown and described herein there may be substituted any other device by which a slit opening could be presented before the observer with a frequency as in the case assumed, for example, of 110 per second. It will also be obvious that the invention may be adapted to any desired maximum or minimum speeds of rotation, and that the number of projections stamped or printed upon the card or disc may be changed either with or without a corresponding change in the periodicity of the tuning fork or equivalent device.

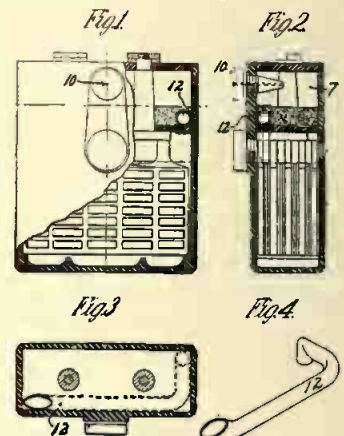

Storage Battery Vent.

(No. 1,160,491; issued to Phelps Brown.)

Ingenious device for venting storage batteries of the acid type. A splash chamber 7, is provided with a peculiarly shaped tube 12, joining this chamber with the one below containing the plates of the cell. In this fashion gas may pass up into the splash chamber and out through the perforated plug 10. Any acid splashing into the upper chamber will readily pass back through the tube 12, and it is claimed that when properly designed that no capillary leakage of the electrolyte can take place.

Electric Cluster Light.

(No. 1,169,346; issued to Thomas O'Donnell.)

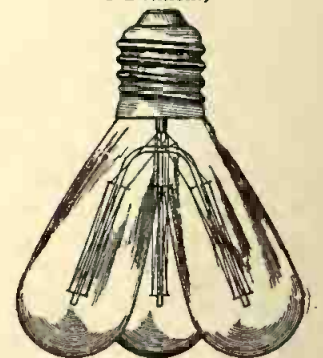

An ingenious arrangement for combining several electric lamp bulbs into a common unit, as perceived from illustration. A very good idea for lamps which are to be used in public places, etc., and capable of giving a more even distribution of the intrinsic brilliancy than when one bulb is used with a concentrated filament of equivalent candlepower. A standard Edison screw base may be used for this cluster lamp. The filaments may be connected on multiple or in series as the manufacturer may elect.

COPIES OF ANY OF THE ABOVE PATENTS SUPPLIED AT 10c. EACH.

Phoney Patents

Under this heading are published electrical or mechanical ideas which our clever inventors, for reasons best known to themselves, have as yet not patented. We furthermore call attention to our celebrated Phoney Patent Offizz for the relief of all suffering daffy inventors in this country as well as for the entire universe.

We are revolutionizing the Patent business and OFFER YOU THREE DOLLARS (\$3.00) FOR THE BEST PATENT. If you take your Phoney Patent to Washington, they charge you \$20.00 for the initial fee and

then you haven't a smell of the Patent yet. After they have allowed the Patent, you must pay another \$20.00 as a final fee. That's \$40.00!! WE PAY YOU \$3.00 and grant you a Phoney Patent in the bargain, so you save \$43.00!! When sending in your Phoney Patent application, be sure that it is as daffy as a lovesick bat. The daffier, the better. Simple sketches and a short description will help our staff of Phoney Patent examiners to issue a Phoney Patent on your invention in a jiffy.

PHONEY PATENT OFFIZZ

Patent Applied

No. 1492
23° S.W.

AN ELECTRO-MECHANICAL BREATHMOTOR

September Morn, 1813

To whom it may confound:

Be it known that I, O. Bedamed, a denizen of Luny Park and a resident of the local Institution, second floor, padded cell number 4, have invented a new and useful Improved Means for generating current, of which the following is a full, intoxicated execution.

This invention relates to a means for utilizing the heretofore wasted energy gen-

however, that the gentle cow has six stomachs.

When said position is assumed the stomach is in position to do overtime work, and for every inhalation and exhalation there will be a movement of attachment 1 (which is erected to conform with the natural formation of the protruberance) and a corresponding movement of the rod 2 and the lever 3, which moves on axis 4; the end of

19. A breathmotor which will earn 1,765 per cent. on investments in free lodging houses by generating, without cost, sufficient current to light Broadway, Chinatown and Sing Sing.

In testimony whereof, I firmly fix four former friends' fingerprints in the presents of these two tired and totally trustworthy allies, and witnessed this 30th morning of February, 1812.

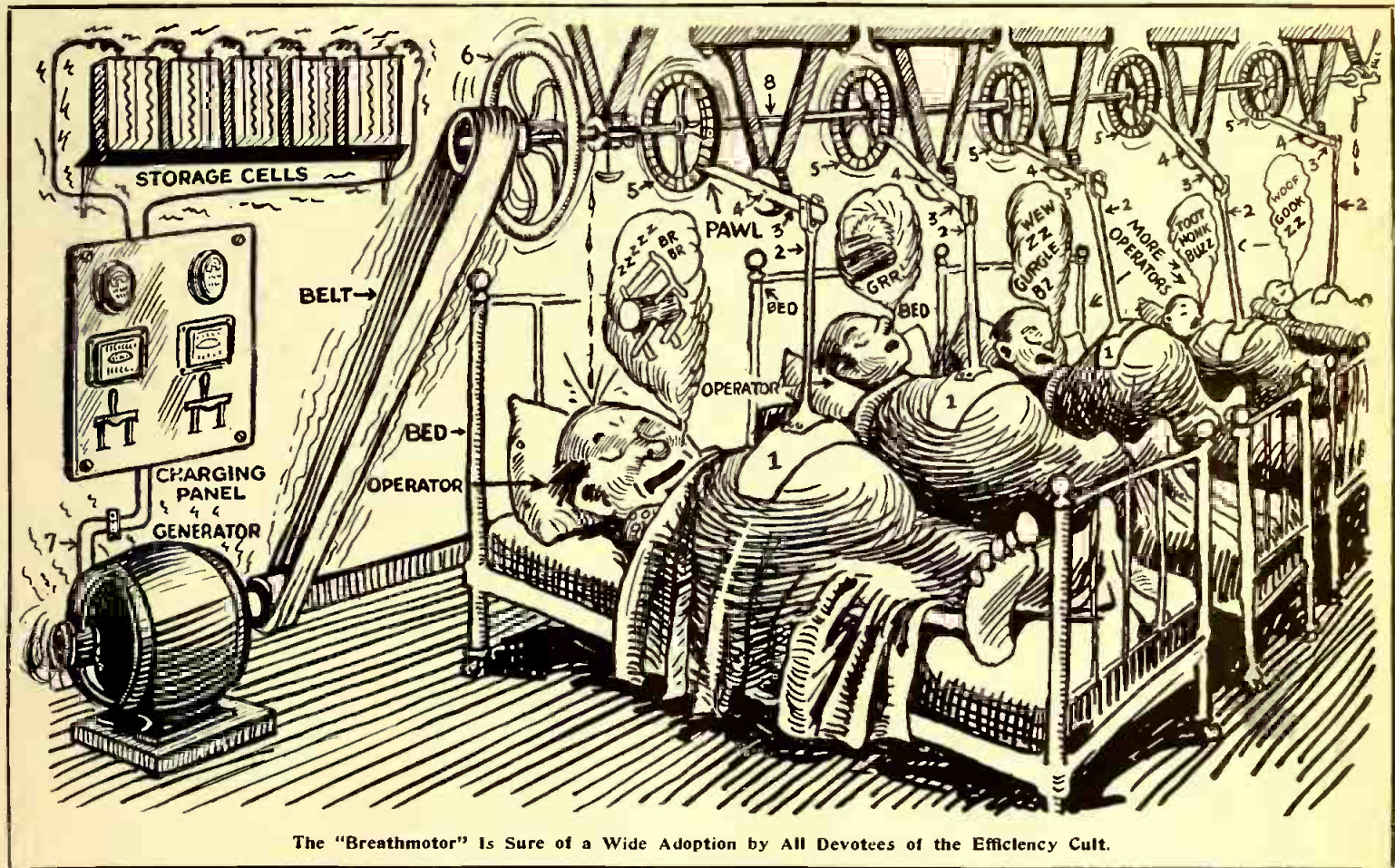

The "Breathmotor" Is Sure of a Wide Adoption by All Devotees of the Efficiency Cult.

erated by mankind, and has for an object the production of electric power.

Another object is the utilization of waste muscular energy. (The word waste has no reference to Her waiste.)

This invention converts the perpendicular movement of chest and stomach by means of levers, ratchet wheel, belt, and dynamo, into electrical energy, which said energy may be disposed of in various ways, such as heating a Chicken incubator, or operating an automatic spanker for conserving the skin on the palm of Father's hand.

The action of the apparatus is as follows: The victim retires (this does not have reference to a Ford owner) and assumes a horizontal position with the stomach uppermost. The petitioner assumes that the operator is a man, for said petitioner has no knowledge of the anatomy of the gentler sex, and cannot affirm his belief to the presence of said stomach in said sex. Said petitioner has been informed,

the lever 3 has attached thereon a pawl which engages with the ratchet wheels and produces a circulatory movement to the balance wheel, 6, and to the shaft on which said wheel is attached. This motion is transmigrated to the dynamo, 7. If the speed is too slow, a governor, 8, connects a current to the victim, and causes his respiratory action to increase surprisingly.

What I claim is:—

1. A breathmotor which will utilize the energy wasted by bums, loafers, and tin-horn sports who wear checkered clothes and put their thumbs in their suspenders. This arrangement will be a boon to women who have said bums, as they can run a washing machine, butter churn, wood saw or ensilage cutter by electricity.

4. A breathmotor by which energy can be collected in such places as Hotel De Gink, Hoboes' Heavenly Home, Weary Willie's Wrestling Palace, and Trusting Tramps' Trast.

(Signed) O. BEDAMED,

By his attorney,
F. S. Schlink.

Witnesses: I. M. Busted, Gosh A. Mity, Hoop S. Mydeer.

BUZZER AWOKED HIM TO SPY ON SPOUSE.

Electrical dealers in Washington, D. C., are making the most of the published announcements of a recent divorce suit in that city. The case is that of Mrs. Emma S. Bullis against Dr. M. C. Bullis.

In his cross-bill the doctor told how he kept track of his wife's movements during the night, although she slept in an adjoining room. He attached two small wires to the door of her room, connecting them through an electric battery to a small buzzer on a cord, which he wore around his neck. The moment his wife's door opened or closed he was awakened and was on the *qui vive*.

QUESTION BOX

This department is for the sole benefit of the electrical experimenter. Questions will be answered here for the benefit of all, but only matter of sufficient interest will be published. Rules under which questions will be answered:

1. Only three questions can be submitted to be answered.
2. Only one side of sheet to be written on; matter must be typewritten or else written in ink, no penciled matter considered.
3. Sketches, diagrams, etc., must be on separate sheets. Questions addressed to this department cannot be answered by mail.

COMPOUND WOUND DYNAMO.

(471.) L. A. Madison, Kingman, Me., wishes to know: 1. What is the largest motor he can run on the current from a 125-volt, 44-ampere dynamo. 2. Whether it is possible to operate a compound wound dynamo in the reverse direction and obtain current from same. 3. The receiving range he would have using an aerial 100 feet long and 75 feet high, with a galena detector, tuning coil, variable condenser and 2,000 ohm phones.

A. 1. The largest motor that you can run with this dynamo is about 7 h.p.

A. 2. A compound wound dynamo can be run in the reverse direction providing the windings of the series field and armature are changed, or the shunt field winding may be reversed.

A. 3. The distance which you can receive with the apparatus mentioned would be between 900 and 1,200 miles. This distance would be increased under favorable atmospheric conditions.

HIGH FREQUENCY COIL.

(472.) John A. McGuire, Ridgewood, N. J., asks: 1. Whether the high frequency outfit described in the November, 1915, issue of *The Electrical Experimenter* can be operated on spark coils. 2. Whether a 2-inch coil would operate this outfit.

A. 1. The high frequency outfit you mention will work on a 6-inch spark coil.

A. 2. It will not work efficiently on as small a coil as a 2-inch one.

STREET ARC LIGHTS.

(473.) Claude Martin, Brownwood, Tex., desires to know: 1. How street arc lights are connected in series so that when one burns out it does not affect the other lamps; also how this works out in series tungsten lighting schemes. 2. Why he was not able to charge a one pint Leyden jar

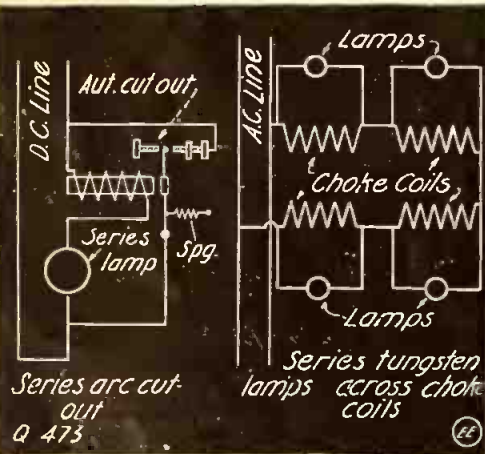

Automatic Cut-outs Used in Series Lighting Systems.

with a 1/2-inch spark coil. 3. Whether the Standard Electrical Dictionary by Prof. O'Connor Slone is self-pronouncing.

A. 1. This system is so arranged that a cut-out properly connected to each lamp, automatically operates a switch which will

keep the other lamps still burning when one lamp burns out. The diagram herewith shows how this cut-out is connected.

A. 2. The reasons for not being able to charge the Leyden jar with a 1/2-inch coil is perhaps due to the fact that the jar was punctured, thus allowing the spark to pass through the dielectric.

A. 3. The dictionary is not a self-pronouncing one. We believe that it is impossible to obtain such a dictionary.

SLATE SWITCHBOARD.

(474.) Albert R. Saunders, New York City, wishes us to give: 1. The connec-

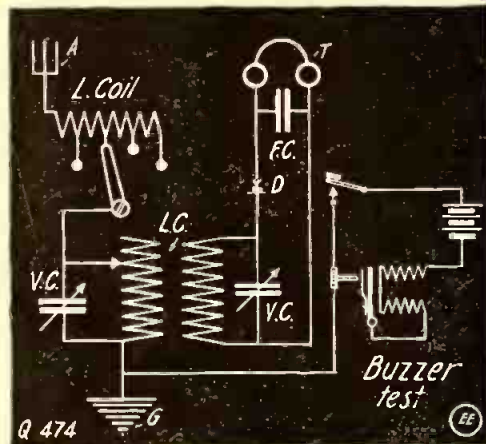

Radio Receiving Hook-up with Buzzer Test.

tions for loose coupler, duplex loading coils (four of different capacities), two variable condensers, fixed condenser, galena detector with buzzer test and phones. 2. What size wire and how much in each loading coil of the following dimensions: 1,000 meters, 1,400 meters, 2,000 meters, 2,500 meters. 3. How slate can be cut and drilled for a switchboard.

A. 1. The accompanying illustration gives the connections you desire.

A. 2. The following is the size and quantity of wire required for the various loading coils: For 1,000 meters, 330 feet; 1,400 meters, 450 feet; 2,000 meters, 660 feet; 2,500 meters, 850 feet, all No. 24 S. C. C. magnet wire.

A. 3. Slate is usually cut with a hack saw and drilled with twist drills, applying water to the drill in order to soften the slate.

THE FOURTH DIMENSION.

(475.) Morris K. Jessup, Rockville, Ind., desires us to tell him: 1. How to make a selenium cell. 2. Where he can find a book on the "fourth dimension."

A. 1. Selenium cells are usually made by winding two separate wires on an insulating material, such as mica, and applying a very thin coat of metallic selenium over same. After the metallic selenium has been applied the cell is carefully annealed. This process of annealing is accomplished by placing the cell for two to three hours in an oven and keeping the temperature just a few degrees below the melting point

of the selenium. It is then allowed to cool gradually.

Our August, 1914, issue contained an excellent method of making selenium cells.

A. 2. The best book on this subject, "A Primer of Higher Space" (the fourth dimension), is supplied by us at \$1.25 prepaid.

VARIOMETER.

(476.) Lloyd Bossirman, Pleasanton, Kan., wishes us to tell him: 1. The size and amount of wire necessary for building a variometer. 2. The wave length obtained by the use of above mentioned variometer and a loss coupler, the primary of which is 9x5 1/4 inches, with an antenna of two wires 500 feet long and a 50-foot lead-in. 3. The time that Fort Riley and Fort Leavenworth, Kan., and St. Louis, Mo., operate.

A. 1. The size of wire necessary for building the variometer would be No. 18 S. C. C. magnet wire, and the amount would depend upon the size of the coil. We think that about 50 feet of this wire would be required for winding the two coils.

A. 2. The wave length obtained with the above-mentioned instruments and the specified antenna would be about 5,000 meters.

3. These stations do not have any particular time for operating.

WAVE LENGTH.

(477.) Bernard J. Biscioti, Philadelphia, Pa., desires to know: 1. The wave length of his antenna, which is 44 feet long and 40 feet high, composed of four wires with a lead-in 10 feet long and a 6-foot ground connection. 2. Whether it is necessary for him to notify the Radio League of America when he installs a transmitting set? 3. How to hook up a buzzer to be operated on a 110 volt, alternating current line?

A. 1. The approximate wave length of your antenna is 150 meters.

A. 2. It will be necessary for you to no-

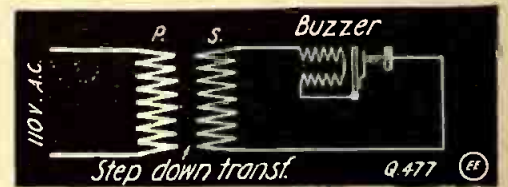

Operating Buzzer on Low Voltage A. C.

tify the Radio League of America whenever you install your transmitting set.

A. 3. The illustration herewith shows the connections for the buzzer which is to be operated on a 110-volt, alternating current line, utilizing a step-down transformer.

KICK-BACK PREVENTER.

(478.) Herbert T. Hintgen, Wahpeton, N. Dak., asks: 1. About some trouble with his electrolytic interrupter. 2. The approximate resistance of the carbons of dry cells.

(Continued on page 722.)

CAT.

No. 16

SEND FOR
IT TO-DAY
YOU NEED IT

Sent FREE for
4c to cover
postage only

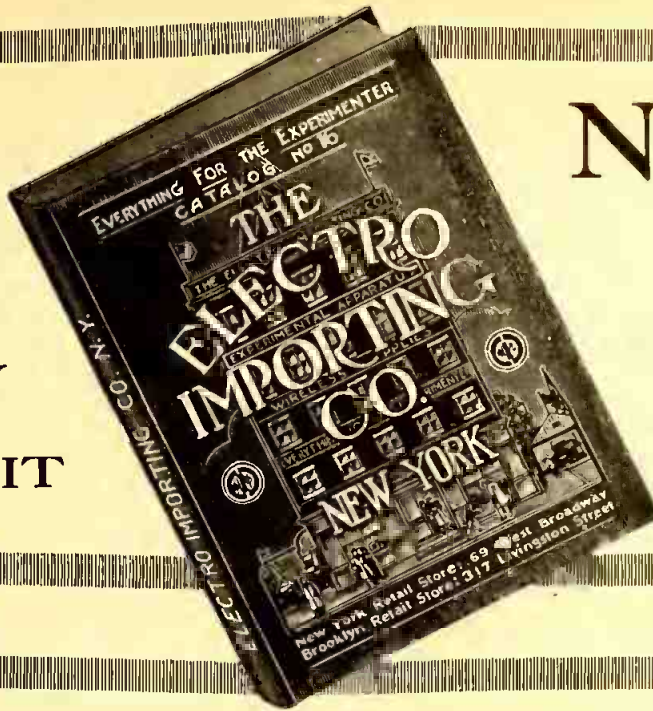

BRANCH STORE No. 1
69 West Broadway
New York City. Retail only

BRANCH STORE No. 2
317 Livingston Street
Brooklyn, N.Y. Retail only

"The Livest Catalog in America"

CONTAINS

Over 2000 Articles

"Everything for the Experimenter"

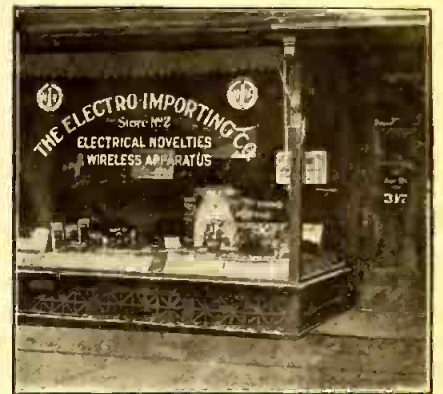
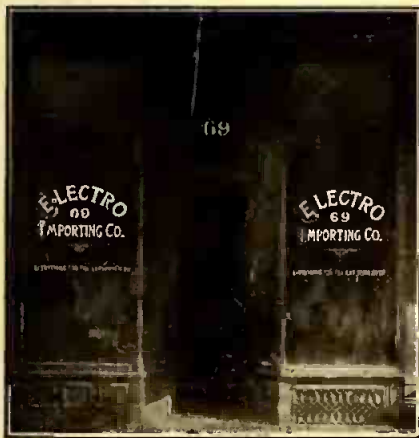

To Accommodate New York City Customers

The ELECTRO IMPORTING CO.

236 Fulton Street, NEW YORK

What Catalog No. 16 Contains

It contains the largest assortment of Wireless and electrical experimental apparatus shown in any catalog published. In addition are shown Commercial Wireless Sending and Receiving Outfits, Electric Motors, Dynamos, Flashlights, Medical Batteries, High Frequency Apparatus, Plating Outfits Toys, Printing Presses, Tools, Sporting Goods and the LARGEST Scientific Book section published. This book will give you as much information as many books that cost you \$1.00 or more. SEND FOR THIS WONDERFUL BOOK TO-DAY, WHICH IS FREE. YOU TO PAY 4c. FOR POSTAGE ONLY.

What Catalog No. 16 Contains

It contains 658 illustrations, 2,000 articles, complete Code Chart of Morse, Continental and Navy Codes, sixteen-page "TREATISE ON WIRELESS TELEGRAPHY," list of Call Letters of U. S. Government and Commercial Ship and Shore Wireless Stations, besides a great many useful tables, and formulas. This valuable book is 6 3/4 x 5 1/4 inches in size and 1/2 inch thick, and well bound. IT IS SENT FREE FOR 4c. TO COVER POSTAGE ONLY.

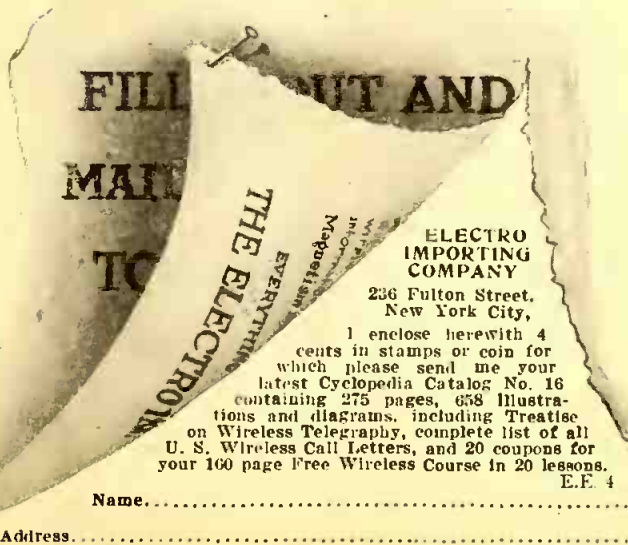

Name.....

Address.....

You benefit by mentioning "The Electrical Experimenter" when writing to advertisers.



"Mignon System"

Apparatus of Scientific Construction
for the Reduction of
Static Interference

High Resonance—Unapproached Selectivity

NO TICKERS NOR ARMSTRONG CIRCUITS REQUIRED
for the reception of CONTINUOUS wave signals if you own a

MIGNON-SYSTEM
CABINET

De Forest Audion Detectors and
Amplifiers

BRANDES RECEIVERS

Crystaloi Detectors, Etc.

Write for R6 Catalog, Dept. "B"

MIGNON WIRELESS
CORPORATION

ELMIRA, N. Y., U. S. A.

WATCH FOR THE

MIGNON TRANSMITTING
CONTROLLER

The Last Word in Sending Equipments

QUESTION BOX. (Continued from page 720.)

3. Whether the kick-back preventer described in the February, 1916, issue of this magazine would be sufficient for the operation of a 1-kilowatt radio transformer?

A. 1. The chemicals in the construction of your electrolytic interrupter are not the right kind, and therefore you have not obtained the satisfactory results. You should use a dilute solution of sulphuric acid composed of one part of the acid to five parts of water.

A. 2. The approximate resistance of the carbons of dry cells is 1/10 to 1/5 ohm.

A. 3. The kick-back preventer described in the February issue can be used with a 1-kilowatt transformer, but we would advise you to obtain a larger one for best results.

10,000 METER LOOSE COUPLER.

(479.) Joseph Frick, Chicago, Ill., wishes us to give him: 1. Details for constructing a 10,000-meter wave length loose coupler and size and kind of wire used. 2. Information regarding the possibility of receiving Lake Bluff, with the use of a tikker in the circuit.

A. 1. A loose coupler having a wave length range of 10,000 meters can be built as follows: The primary of coupler should be 18 inches long and 6 inches in diameter, while the secondary should have a length of 17 inches and diameter of 5 inches. The primary should be wound full of No. 22 copper enamel magnet wire and the secondary with No. 24 copper enamel magnet wire. The taps should be taken out on the primary at every 30 turns and likewise with the secondary.

A. 2. With the aforesaid loose coupler you should have no trouble in receiving Lake Bluff station with a tikker connected in circuit.

ARC EFFECTS.

(480.) Kenneth Preston, Ashland, O., inquires: 1. How he can eliminate the noises developed by an electric arc, which is located near his station? 2. The dimensions of a loading coil necessary for receiving Sayville, L. I.?

A. 1. We would advise you to construct a small auxiliary antenna parallel to the arc light transmission line, connecting the aerial to the ground. (This aerial is, of course, not used for wireless purposes.) Another method which you can use to eliminate the noises developed by the arc is to change the direction of your antenna. However, the former method would be preferable.

A. 2. A loading coil which will tune Sayville, L. I., station can be constructed by employing a tube which is 20 inches long by 5 1/2 inches in diameter, fully wound with one layer of No. 22 B. & S. copper enamel magnet wire.

"CHOPPER" FOR ARC CIRCUITS.

(481.) Lloyd Bosserman, Pleasanton, Kan., sends us a diagram of a radio telephone set, on which he would like to have our opinion as to whether it is correct. 2. He also requests a diagram showing the connection of a "chopper" in the electric arc circuit.

A. 1. The diagram submitted is correct and you will no doubt find it satisfactory for operating over short distances.

A. 2. The accompanying illustration shows the connection for the "chopper." It can be connected in series either with the ground or with the antenna lead. When the station is to be used for the transmission of radio telephonic messages it is only necessary to short circuit the terminals of this instrument. You will undoubtedly find the "chopper" satisfactory for transmitting

Multi-Audi-Fone

Note this Owing to the great advance in the development of the M. A. F. it can now be used with any Head Set you may have and we are going to give our customers all the advantage of the improvement. With our specially wound Head Set, \$23.00; without  \$18

Two Step Multi-Audi-Fone, without Head Set, \$60; with Head Set, \$65. Un-Damped-Waver, according to wave length, \$60 and \$100. Telephone Voice Multiplier for weak lines and poor ears, \$15. Detectorphones for Detectives, County Attorneys, Hotels and Manufacturers, \$35.

Deaf-Man's-Ear is for you, if you are deaf and want to hear, \$35. Send for circular to-day and don't fail to name which instrument.

MULTI-AUDI-FONE, 275 Morris Ave., Elizabeth, N. J.

AUDIO-ROTOR



For Undamped Wave Receiving

Copy Tuckerton, Sayville, Arlington, Nauen, Honolulu, Darien. This little instrument will do wonders you never dreamed of. Price \$5.00, prepaid.

CQ! CQ! CQ!

Important news messages from high powered stations using the undamped wave are passing over your aerial. The AUDIO-ROTOR connected in any receiving system enables you to copy the undamped wave without the use of other devices.

MONOTONE QUENCHED SPARK GAP

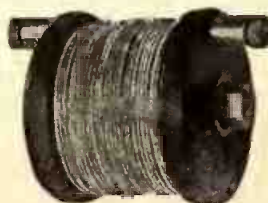

Quiet in Operation, Arcless, Penetrating

Already used by hundreds of operators. Only one unit required for spark coils. Transformers require two units for every 1/4 KW Power. Per unit \$1.50, prepaid.

RICHARDSON COMPANY, Commerce Bldg., ERIE, PA.

radio telegraphic signals or for calling when using the arc for the production of high frequency oscillations.

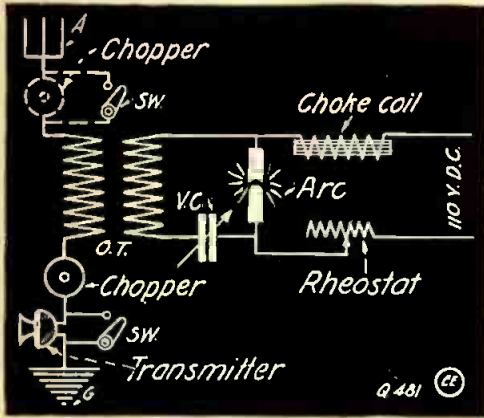

Connection of "Chopper" in Radiophone Circuit.

RECEIVING RANGE.

(482.) Chester Barnes, Linton, Ind., wishes us to tell him: 1. How far he would be able to receive with the following instruments: Receiving transformer, rotary variable condenser, fixed condenser, 2,000-meter loading coil, Murdock detector, 3,000-ohm receivers. 2. Whether a loading coil increases the value of the receiving range. 3. The best detector for use in wireless telegraphy.

A. 1. With these instruments you should be able to receive 800 to 1,200 miles under favorable conditions. This can, of course, be increased by using a large antenna.

A. 2. A loading coil is only used for receiving longer waves than the natural wave length of your antenna. It is not necessary to tune for such unless the distant station is transmitting a longer wave length than your normal receiving set responds to.

A. 3. The two best detectors used in wireless receiving stations are possibly the Audion and Radioson detectors.

RADIO HOOK-UPS.

(483.) Vincent Natalish, New York City, wishes to have: 1. A hook-up for the following instruments: A Navy type loose coupler, variable condenser, detector, 'phones and switch for cutting in a loading coil for increasing the wave length. 2. Diagram for a one-inch spark coil gap, helix, condenser or Leyden jars and key. 3. Information regarding which is preferable—Leyden jars or unit condensers of other types.

A. 1. The accompanying diagram gives the connections for the instruments you mention.

A. 2. The second illustration shows the

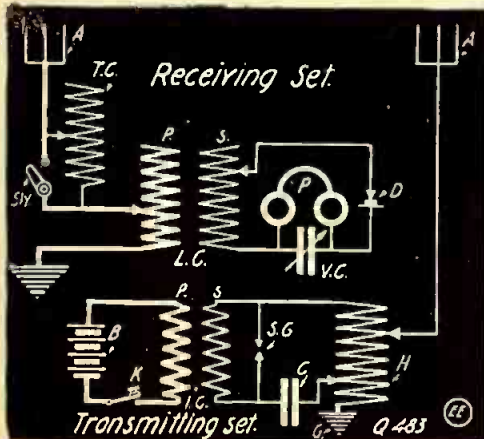

Radio Sending and Receiving Circuits.

connections for the transmitting instruments you have specified.

A. 3. It is more advisable to use sec-



"I Received Messages from San Francisco (2100 Miles) with CRYSTALOI"



"July 9th, while at anchor in Kahului Harbor, Hawaiian Islands, I copied K P H San Francisco Press with Crystalloi, at a distance of 2100 miles."
(Signed) A. H. RANDOW, Operator, S. S. Dakotan.

CRYSTALOI
The Highly Sensitive, Permanent
WIRELESS DETECTOR

Is Making New Records Like This Every Day

Crystalloi is the only practical wireless detector affording innumerable contact points. Due to its peculiar construction, embracing a very sensitive mineral which is brought into contact with a light, finely divided alloy, it is remarkably free from static and other interferences. Tests have shown that Crystalloi actually reduces static one-half. With proper use it will last a lifetime without repair, adjustment or attention of any kind.

3 TYPES
Crystalloi.

TYPE O—Dimensions 2 1/4" x 1 7/8".
Price, \$3.50. Mailing Weight, 1 lb.

TYPE AA—Equipped with a cohering inductance—Dimensions 4" x 3 1/2".
Price, \$6.00. Mailing Weight, 2 lbs.

TYPE BB—Equipped with cohering inductance, fixed condenser, buzzer, test and frequency control. Dimensions, 7 1/2" x 5 1/2" x 3 1/2".
Price, \$12.00. Mailing Weight, 4 lbs.



TYPE AA. SUPER-SENSITIVE

All Live Dealers Carry Crystalloi. If your dealer cannot supply you, write us. Catalog "C," fully describing Crystalloi and all of our other High-Class Receiving Apparatus, sent on receipt of 5 cents in stamps.

Eugene T. Turney Co.

INCORPORATED

2595 Third Avenue

New York City

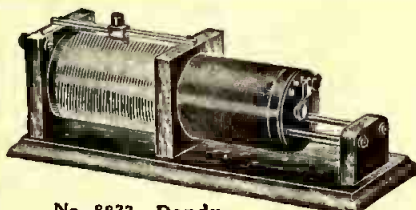

No. 8833. Dandy Receiving Transformer, \$5.40

We also Manufacture
Telegraph and Fire Alarm Apparatus,
Dry Batteries,
Medical Batteries,
Bells, Line Equipment,
Novelties,
Etc.

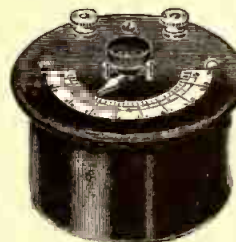

No. 8654. Dandy Rotary Variable Condenser, \$3.30

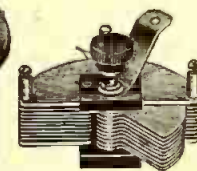

No. 8834. Jove Receiving Transformer, \$7.50

Are You looking for Quality—Design and Workmanship consistent with price?

If you are, then get our catalog No. 36E. Illustrating and describing about 300 articles of Amateur Radio Telegraph apparatus.

J. H. Bunnell & Co., Inc.

32 Park Place

Broadway Block

NEW YORK

Chicago Wireless Headquarters

CLOSING OUT LARGE LINE OF RAW MATERIALS, PARTS, Etc.

ROTARY VARIABLE CONDENSERS

Only transparent rotary variable condenser made that can be screwed down, filled with oil to increase capacity and has binding posts on bottom where they belong. The 43 plate condenser has a capacity of .001 m.f. The 17 plate has a capacity of .0003 m.f.

No. 9240—17 Plate Rotary Variable Condenser, \$2.25

No. 9241—43 “ “ “ “ “ 3.75

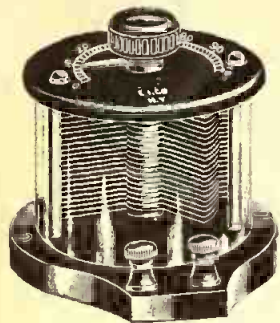

No. 10. TUNGSTEN FLASHLIGHT
6 inches long, complete 65c.
Extra battery, . . . 20c. Extra bulb, . . . 15c.

60 and 100 Watt Nitrogen Lamps use less current; give white light.
60 Watt, . . . 85c. 100 Watt, . . . 90c.



No. 125. TUNGSTEN NICKEL VEST POCKET FLASHLIGHTS with Tungsten bulb and Ever-Ready Battery, complete, . . . 45c.
Extra bulb, 15c. Extra battery, 20c.

FINE 50c. POCKET CIGAR LIGHTER. Turn the wheel. Flint good for 5,000 lights. (2 for 25c.) or each 15c. New Flints, 5c. 6 for 25c.

We carry a very complete line of Wireless Apparatus in stock, being Chicago headquarters for the Electro Importing Co. Same prices, same goods and Free Wireless Course. Lionel Trains. Motors. Transformers, Wireless Outfits. Structo Metal Building Material, Automobile and Electrical Supplies. Send 4c. in stamps for complete catalogs.

LA SALLE LIGHT COMPANY, 134-136 N. La Salle St., Chicago, Ill., Opposite City Hall

NEW WIRELESS WONDER

THE INSTANT RADIOGRAPH

Greatest invention of the Age. The result of years of experimentation.

Abolishes detector troubles and adjustments—

No more delays—no more lost time and messages

Pick up your receivers any time, Summer or Winter, in any atmospheric conditions and—

You Can Receive Instantly Without Any Adjusting

3,000 miles is latest record of the Instant Radiograph.

It is wonderful, but true, you cannot get the Instant Radiograph out of adjustment no matter how you knock it about. Try it yourself, hit it with a hammer while in use.

Vibrations, jars, knocks cannot affect it as there are no fine adjustments to make—no batteries—nothing to wear out—no operating expense whatever.

INTRODUCTORY
PRICE FOR
MARCH

\$3.00

The Instant Radiograph is more efficient than any detector on the market, as there is nothing to adjust.

The Instant Radiograph is beautifully and solidly constructed on a heavy base of hard rubber 4 x 4 inches square with rounded corners and 4 1/4 inches high; binding posts are made of non-corroding metal, heavily silver plated, and have heavy rubber-covered thumb screws, preventing current leakage. All contacts are large, non-corroding, heavily silver plated, of large size and will last a lifetime. This is a wonderful instrument of distinctive appearance that you will be proud to have in your wireless station.

The Radiograph is the greatest recent invention in the Wireless field. Its value is priceless and as we want every professional and amateur operator on land and on board ships to use it, we have decided to make an introductory price of \$3.00 for a limited time only. This is only one-third of the price at which it should be sold. Send your order at once. Send for free Catalog E of the Instant Radiograph.

You need this new book, "Radio Stations of the World." A complete authentic list of call signals of every public wireless station. Price, only 50c.

UNIVERSAL WIRELESS COMPANY,

19 East 32nd St., New York

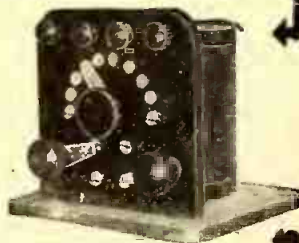

Cut 1/4 Actual Size.

This Selective and Efficient Tuner Only \$8.00

"Your new tuner with switches is very satisfactory and much more selective and efficient than other type although that one does splendid work. Henry Wheat, Jr., Geneva, N. Y."

We also make a 10,000 meter tuner. Send 2-cent Stamp for Bulletin 107

Colby's Telegraph School
Auburn, N. Y.

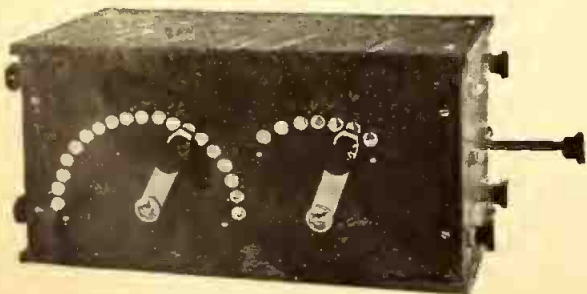

tional condensers in a transmitting station than Leyden jars, as the former are less bulky.

TELEGRAPHONE QUERIES.

(484.) Joseph A. Wensk, Baltimore, Md., wishes to know: 1. Whether the plates and supports of the Telegraphone, which was described in the June, 1915, issue of *The Electrical Experimenter*, can be built of wood instead of aluminum? 2. Whether he can receive the Sayville station with the use of Dr. Cohen's new receiving set hook-up? 3. The quantity and size of wire required to build two coils, each have 15 ohms resistance.

A. 1. These parts could be satisfactorily built of wood, but the wear and tear on same is such that if they are built of aluminum they will last much longer.

A. 2. You will undoubtedly be able to receive the Sayville wireless station by the use of Dr. Cohen's improved hook-up if a proper inductance is added to your antenna circuit. We would advise you to obtain a very large inductance, having at least a wave length of 7,000 meters, as the wave length used by this station is about 9,000 meters.

A. 3. For building these coils we would suggest to use 640 feet of No. 36 B. & S. copper magnet wire.

DRY BATTERIES.

(485.) William Entress, Unionport, N. Y., wants to know: 1. The compound used in making dry cells and the quantity of same. 2. Whether a Geissler tube can be operated on a small medical coil?

A. 1. The moisture retaining compound used in constructing primary dry cells is: Ammonium chloride, 1 part; plaster of paris, 3 parts; zinc oxide, 1 part, and a sufficient amount of sawdust to cover the paste.

A. 2. A small medical induction coil will not operate a Geissler tube. You must use a coil giving at least a one-eighth inch spark.

LOOSE COUPLER.

(486.) Edward Updike, Niles, Mich., wishes us to tell him: 1. Whether a loose coupler would be improved if the primary of the coil were wound over an iron tube? 2. Whether a resistance should be connected in series with an arc.

A. 1. The primary coil of a loose coupler should never be wound over an iron core, as the impedance of the coil would be increased and thus inferior results would be obtained. However, other metallic tubes can be employed experimentally if desired, but careful insulation must be made between the tube and the winding. Also the tube should be slit longitudinally, to prevent eddy currents circulating through it. The iron core cannot magnetize and demagnetize fast enough for this purpose, resulting in a very low "power factor" and consequent loss.

A. 2. A resistance should invariably be used with the arc.

CHANGING A. C. TO D. C.

(487.) John T. Alderman, Jr., Henderson, N. C., wants to know: 1. Whether a 1/2-kilowatt radio transformer can be used for operating an X-ray or Tesla transformer? 2. Whether a buzzer transmitter can be made from an ordinary buzzer? 3. How 110 volt, A. C. can be converted into D. C.?

A. 1. A 1/2-kilowatt transformer can readily operate an X-ray or Tesla transformer, providing it is not too large.

A. 2. A buzzer transmitter can be made from an ordinary buzzer. However, larger coils should preferably be used in building such a device, so that a greater amount

VIOLET RAYS

NEWEST FORM OF ELECTRICITY FOR YOUR OWN PERSONAL USE

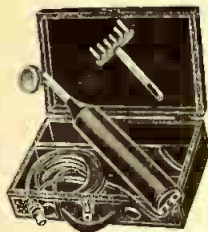

The VIOLETTA HIGH-FREQUENCY GENERATOR is used and endorsed by thousands of physicians. It generates the Violet-Ray High-Frequency Current which is used with wonderfully quick results for facial, scalp, and body treatments.

Contact efficient, operates on alternating or direct current, and absolutely safe and guaranteed. A scientific marvel in construction. Write for our beautifully illustrated booklet G.

AGENTS and DEALERS RESPOND

Bleadon-Dunn Co., 208 N. 5th Ave., Chicago, Ill.

REPAIRS—9 XE—SUPPLIES WIRELESS

Send us your Spark Gap Motors. We repair any wireless instrument. Our wireless repair men do this work. IN STOCK—all kinds and makes of Tuners, Detectors, Phones, Transformers, Etc. Give us a trial. We answer letters.

9 XE-WIRELESS REPAIR & SUPPLY COMPANY
DAVENPORT, IOWA

8,000 MILES

is the record (amateur) with our Audio-Tron Detector

THE AUDIO-TRON
DETECTOR—AMPLIFIER—OSCILLATOR

Price postpaid \$6.50

Jensen Electric Co.

RADIO APPARATUS
and SUPPLIES

SEND STAMP FOR CATALOG

1949 Huron Street CHICAGO, ILL.

WIRELESS SUPPLIES

LARGE STOCKS
of Electrical and
Wireless Apparatus



AND INTELLIGENT SERVICE

As agents for The Electro Importing Co. and J. H. Bunnell & Co., we assure you of quality merchandise at lowest prices.

QUAKER LIGHT SUPPLY CO., 728 ARCH ST., PHILA., PA.

25- WATT "WIRELESS" TRANSFORMER \$15.00

Closed Core Type 14,000 VOLTS 3 Different Powers Self Contained Shipping Weight—20 lbs.

Folders and information descriptive of these 1/2 K. W. transformers may be had for the asking—also of our 500 and 750 watt capacities.

Winger's Code Charts—large size Continental—Post Paid—15c., small or pocket size 10c. They enable you to learn the code more quickly than by any other method.

Our New Detector (cat whisker type) is "Some" Detector—it is a marvel of simplicity and dependability—base is of Vulcanized Fibre and is furnished with Two crystal holders—one Cupholder and one Looped Spring holder—Post Paid 50c. WINGER ELECTRIC & MFG. CO., 711 S. Dearborn St., Chicago, Ill.

READ the Classified Advertisements in this issue. They are small but contain big bargains and opportunities.

of current can be supplied to the coils and thus a greater range obtained.

A. 3. There are two methods by which you can readily convert 110 A. C. to D. C. One is to employ a rotary converter of the electrical type or a mechanical converter. The second and easier method, although not as efficient for converting same, makes use of an electrolytic rectifier.

WATER RHEOSTAT.

(488.) Clarence F. Kramer, Lebanon, Ind., wants to know: 1. How many small incandescent electric bulbs can be lighted by the current generated from an ordinary three-bar telephone magneto? 2. How it is possible to step-down 110 volt, 60 cycle A. C. to such a voltage as would operate a hand feed arc lamp? 3. Whether it is possible to employ a water rheostat for reducing said voltage to the proper value for operating the arc lamp?

A. 1. Only by rewinding the magneto with, say, No. 24 enamel wire will you be able to light up about two six-volt, two-candlepower lamps. The ordinary magneto uses very fine wire, usually No. 36 or finer, with a resistance varying from 600 to 10,000 ohms. Such a magneto will not light a lamp.

A. 2. The 110-volt, 60 cycle A. C. can be reduced to a suitable value for operating a hand feed arc lamp by employing a water rheostat.

A. 3. You can readily use a water rheostat for reducing 110 volts. The accom-

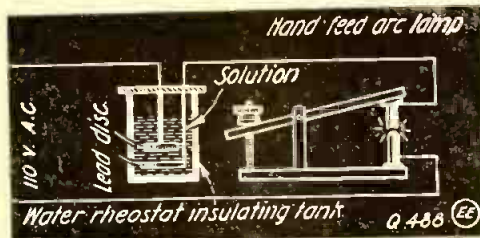

Use of Water Rheostat in Arc Circuit.

panying illustration gives the method for connecting the rheostat.

USES FOR OLD PHONOGRAPH RECORDS.

(489.) H. M. Clay, Shelbyville, Ky., wishes to know how he can melt old phonograph records so that he may use the molten material for making parts for wireless instruments?

A. The best method by which you can melt the phonograph records is to employ an ordinary carpenter's glue pot, filling the inner chamber with broken parts of the record and the external chamber with water and then applying a low heat to the pot. Care should be taken to see that the molten material does not burn, as it can readily catch fire and thus destroy its insulating properties. You will obtain better results with a good grade of stationer's sealing wax.

SPARKING UNDER DYNAMO BRUSHES.

(490.) H. A. Wright, West Barnstable, Mass., wishes us to tell him: 1. The size of wire to be used in building the armature and fields for a two pole, shunt wound dynamo developing 12 volts. 2. The cause of sparking at the commutator.

A. 1. We would advise you to use No. 28 wire on the field coils and No. 26 copper magnet wire on the armature coils.

A. 2. The cause of sparking under the brushes may be due to several reasons, some of which are as follows: The brushes possibly may not be set correctly, pressing too hard or unevenly against the commutator. (Continued on page 727.)

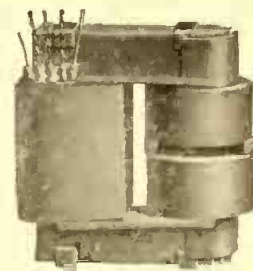

UNMOUNTED TRANSFORMER

You Can Get Results

with a small condenser and this transformer

It is a 1-2 K. W. size and is built on the same specifications as to material and workmanship, etc., as our big central station transformers.

Hundreds of stations are now using these transformers. This transformer gives you 13,200 volts.

Let us tell you how you can do part of the work yourself and get this transformer at a remarkably low cost.

THE PACKARD ELECTRIC CO.
555 Dana Avenue Warren, Ohio

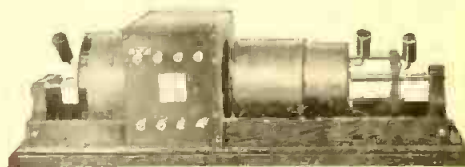

Type AML

The Precision Varicoupler

Patented Mar. 7, 1916, foreign patents pending.

Up-to-date receiving circuits require improved apparatus. You can't get super-sensitiveness with old style couplers. The Precision Varicoupler is PERFECTION in receiving tuners. It has

- No Taps
- No Sliders
- No Switches
- No Delicate Parts
- No "Dead Ends"
- All the Wire in
- No Contacts
- Use all the Time

and is finished in mission oak, genuine cut hard rubber, silver finished wire, etc.

5 Styles, \$10 to \$25

For detailed information write for bulletin PL.

The Precision Radio Equipment Co., Inc.
General Office: 868 Putnam Ave., Brooklyn, N. Y.

LOOK! A NEW CHAMBERS COUPLER No. 744, PRICE ONLY \$4.50



Positively unequalled for the money. Is 6" high, 6" wide, and 14" over all. Wound with E nameled wire, and has a very unique slider. Wood-work mahogany.

any finished. Try one, you will not be disappointed. 5c. in stamps brings our 64-page illustrated catalogue, B-B-24. None otherwise.

F. B. Chambers & Co. 2046 Arch Street Philadelphia, Pa.

The Great Announcement

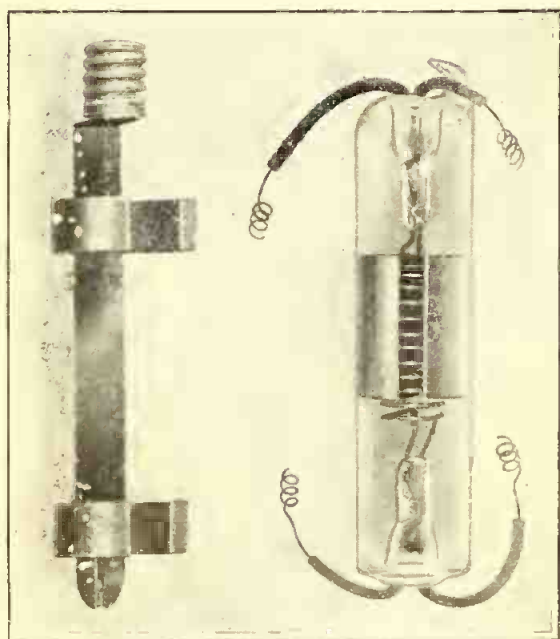

THE NEW TUBULAR AUDION BULB will be sold **SEPARATE** from our instruments, taking effect **March 15th**.

This bulb brings in signals very loudly. It has a single, straightline filament of very long life and is certain to be a very popular type. Made in one grade only, every bulb passing our usual and careful test.

To those who cannot afford our complete detectors with round bulb, this offer will be of immense interest.

Price—\$5.50 each, postpaid, or from any of our 45 distributors.

The adapter illustrated above is not furnished with the bulb, but is 40 cents extra. It adapts the bulb to a regular screw socket.

ROUND AUDION BULBS will still be sold, as heretofore, as renewals only for De Forest instruments, and only on return of the old bulb.

NEW BULLETIN X16 on the type T, Tubular Audion Bulb, will be sent if you enclose stamp.

Type RJ8

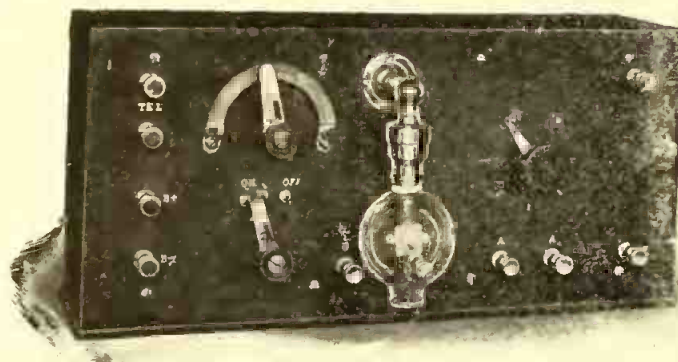

PRICE, \$25.00

New De Forest Audion Detector

THE BEST AUDION DETECTOR EVER OFFERED FOR PRIVATE USE

¶ The Audion Detector is the most sensitive detector in existence. (Bulletin U. S. Bureau of Standards, Vol. 6, No. 4, Page 540.) The new and improved forms are more sensitive, more reliable and more adaptable than ever before. The new Type RJ8 Audion Detector represents the greatest value for the money ever offered.

¶ It is equipped with potentiometer control for the high voltage circuit, giving extremely close regulation which is so essential to obtaining utmost efficiency with the Audion. It is a panel type instrument of the very best construction. It is thoroughly reliable and constant in operation, is not affected by mechanical vibration or by the transmitting spark, and is always to be depended upon for reception of signals over the greatest possible ranges.

¶ It is worth a stamp for you to be informed on this and the other new De Forest instruments.

“There is only ONE AUDION—the DE FOREST”

Send stamp for M 16 Bulletin on the New Audions

De Forest Radio Telephone & Telegraph Co.
101 PARK AVENUE, NEW YORK CITY

QUESTION BOX.
(Continued from page 725.)

tor, bearings too loose, short circuited segments, loose segments, overloading and overheating of the armature coils. Sometimes carbon brushes are gritty. Boil them in paraffine wax. Try carbon or graphite brushes with woven copper wire centers. Carbon brushes often have too high a resistance.

CONSTRUCTION OF PHONOGRAPHIC CYLINDERS.

(491.) James Fitzpatrick, Darlington, Pa., wants to know: 1. Whether a buzzer set operated by flashlight batteries can be used for exploding photographic flashlight powder? 2. How phonographic records are made?

A. 1. A buzzer set with sufficient amount of flashlight batteries and properly connected can successfully be used to explode the photographic flashlight powder.

A. 2. It would be impossible for us to go into the details of the construction of cylindrical phonographic records, as the process is somewhat complicated for explanation in our Question Department. However, we would say that a soft record plate is first produced and from this a metallic mold is built, in which all duplicates are made. We would advise you to write to several phonographic record manufacturers of this country and ask them to give you data as to the construction of their records. They may probably give you a general description of the method they use.

PHOTOGRAPHIC PLATES.

(492.) Francis Crump, Jr., Columbus, Ind., wants to know: 1. The chemicals used in making photographic plates. 2. The chemicals employed in manufacturing gas-light printing paper and how it is prepared.

A. 1. Photographic plates are made out of glass upon which a coating of gelatinous silver bromide is applied. The coating of this material is sensitive to light if applied in a darkened room.

A. 2. Gaslight printing paper is usually made with silver chloride in which a small trace of silver bromide is added. This material is mixed with a gelatinous compound and applied to sheets of paper.

WIRELESS IN FAR NORTH.

Wireless telegraphy will be used instead of the old poles and wire by the new Canadian Government Railway which is to connect Hudson Bay with the Canadian Northern at Le Pas, Manitoba.

A chain of wireless stations is already constructed between Port Nelson and Hudson Straits. When put into operation they will mark a new era in railroad telegraphy, for no other road depends solely on wireless over so long a stretch of territory.

There now remains only 100 more miles of grading to be done to complete the road bed from Le Pas to Port Nelson.

TUFTS COLLEGE HAS NEW HIGH POWER RADIO STATION.
(Continued from page 700.)

very latest design, wonderful testing instruments of a very delicate nature, and a perfect set of machinery for experimental purposes. The advantages in using only one aerial, according to Harold J. Power, head of the Atlantic Radio and Research Corporation, comes from the fact that the operators are better able to transmit messages to all points of the compass equally well.

The laboratory is practically sound and vibration proof, allowing the use of the most delicate testing instruments, a very important factor of the research work now being carried on there. Each room was carefully tested by Mr. Power with a microphone. The heavy machinery in the basement was turned on at full power, and not the slightest vibration could be detected in the room above.

On the northerly and westerly sides is the experimental laboratory well supplied with windows, so placed as to get the maximum light on the benches. In the machinery room the base, main shafting and pulleys are set solidly in the concrete floor, while the counter-shafting is bolted to a shelf, reinforced with steel brackets, so placed that rubber shock absorbers may be inserted between them and the floor if necessary.

A large assortment of the latest design testing instruments are to be found in this laboratory. These meters are so delicate that the minute current produced by placing the fingers on the contact buttons is recorded. The floors are all double and lined with heavy layers of felt. The doors are double soundproof. The Tufts Wireless Society will have a room in the building and eventually the plant will revert to Tufts College, together with all the costly instruments and machinery.

The credit for this addition to the electrical equipment of Tufts College, which has long been famous for the electrical engineers it has turned out among its graduates, and which was one of the first colleges in the country to take up radio research work, is due to Harold J. Power, a former student at Tufts and later a wireless operator on various steamers on the Atlantic.

Mr. Power started in wireless experimental work when wireless telegraphy was first being used on a commercial scale; Marconi, a few years previous, having published the results of his early experiments. Young Power, after weeks of hard labor, managed to construct a crude, but very complete wireless transmitting and receiving set. His "laboratory" consisted of a shack in the rear of his home. Little did he realize that 12 years later he was to sit down in a fine modern laboratory of his own and take down a message from Berlin, 4,000 miles away.

\$11.00 Guaranteed Amplifier Coils \$11.00

TRANSFORMERS

Built for Wireless

The Pittsburgh Wireless Equipment Co.

are under new management at

RIDGWAY, PENNSYLVANIA

and are on DECK to give you a SQUARE DEAL and 100% value in our

Superior Radio Apparatus

for every dollar's worth purchased

Send 10c. for our complete catalog. Parts catalog free.

PITTSBURGH WIRELESS EQUIPMENT CO.

Department "R"

RIDGWAY, PENNSYLVANIA

AUDIOLOI

Superior Wireless Detector

SENSITIVENESS GUARANTEED

Money refunded if not found satisfactory in all respects.

Type A, for short distance work, price (postpaid) \$1.50.

Type B, for long distance work, price (postpaid) \$2.50.

SIDNEY ISAACSON

1893 7th Avenue, New York City, N. Y.

8000 MILES

Breaks All Records (Amateur) with Supersensitive

AUDIO-TRON

BULBS \$6.50

DETECTOR—AMPLIFIER and OSCILLATOR

Send TODAY for Interesting Literature

CHELCO ELECTRIC CO.

948 N. TRUMBULL AVE., CHICAGO, ILL.

BE A FRIEND

to your friends. Give them this magazine when you have finished it. They will appreciate it.

"THERE'S MONEY IN IT"

AT HOME

LEARN TELEGRAPHY

AT HOME

MORSE AND WIRELESS

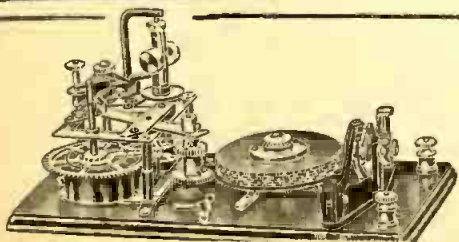

TEACH YOURSELF

in half usual time, at trifling cost, with the wonderful Automatic Transmitter, **THE OMNIGRAPH**. Sends unlimited Morse or Continental messages, at any speed, just as an expert operator would,

Adopted by U. S. Gov't. 4 styles. Catalogue free.

OMNIGRAPH MFG. CO., 39L Cortlandt St., New York



"Pretty soft for him"

OF course, it's pretty soft for the man who has made good. But, if you look behind for the real cause of his success, you'll find that luck played **no** part whatever—**TRAINING** did it. Yes, **TRAINING** secured through spare-time study. **TRAINING** is the **big** difference between you and the man who holds down the sort of job you'd like to have. Don't worry because others get ahead. Train yourself with the help of the International Correspondence Schools for the job you have in mind and you can do as well or even better.

Tens of thousands of men, at one time no better off than you, **now** hold good jobs as the direct result of I. C. S. training. Last year more than five thousand took the trouble to write to the I. C. S. reporting advancement to better positions and bigger pay. These men had the fighting spirit—they simply wouldn't stay down.

Get that spirit yourself. You're a man capable of doing bigger things. Make up your mind to do them. But get started. Every minute gained brings your success so much nearer. Mark and mail this coupon now.

I. C. S., Box 5307, Scranton, Pa.

— CUT OUT HERE —

INTERNATIONAL CORRESPONDENCE SCHOOLS
Box 5307, SCRANTON, PA.

Explain, without obligating me, how I can qualify for the position, or in the subject, before which I mark X.

| | |
|--|--|
| <input type="checkbox"/> ELECTRICAL ENGINEER | <input type="checkbox"/> ADVERTISING MAN |
| <input type="checkbox"/> Electric Lighting | <input type="checkbox"/> Window Trimmer |
| <input type="checkbox"/> Electric Car Running | <input type="checkbox"/> Show Card Writer |
| <input type="checkbox"/> Electric Wiring | <input type="checkbox"/> Outdoor Sign Painter |
| <input type="checkbox"/> Telephone Expert | <input type="checkbox"/> ILLUSTRATOR |
| <input type="checkbox"/> MECHANICAL ENGINEER | <input type="checkbox"/> DESIGNER |
| <input type="checkbox"/> Mechanical Draftsman | <input type="checkbox"/> BOOKKEEPER |
| <input type="checkbox"/> Machine Shop Practice | <input type="checkbox"/> Stenographer and Typist |
| <input type="checkbox"/> Gas Engineer | <input type="checkbox"/> Cert. Pub. Accountant |
| <input type="checkbox"/> CIVIL ENGINEER | <input type="checkbox"/> Railway Accountant |
| <input type="checkbox"/> Surveying and Mapping | <input type="checkbox"/> Commercial Law |
| <input type="checkbox"/> MINE FOREMAN OR ENGR | <input type="checkbox"/> GOOD ENGLISH |
| <input type="checkbox"/> Metallurgist or Inspector | <input type="checkbox"/> Teacher |
| <input type="checkbox"/> STATIONARY ENGINEER | <input type="checkbox"/> Common School Subjects |
| <input type="checkbox"/> Marine Engineer | <input type="checkbox"/> CIVIL SERVICE |
| <input type="checkbox"/> ARCHITECT | <input type="checkbox"/> Railway Mail Clerk |
| <input type="checkbox"/> Contractor and Builder | <input type="checkbox"/> AGRICULTURE |
| <input type="checkbox"/> Architectural Draftsman | <input type="checkbox"/> POULTRY RAISING |
| <input type="checkbox"/> Concrete Builder | <input type="checkbox"/> Textile Overseer or Supt. |
| <input type="checkbox"/> Structural Engineer | <input type="checkbox"/> Navigator <input type="checkbox"/> Spanish |
| <input type="checkbox"/> PLUMBING AND HEATING | <input type="checkbox"/> Chemist <input type="checkbox"/> German |
| <input type="checkbox"/> Sheet Metal Worker | <input type="checkbox"/> AUTO RUNNING <input type="checkbox"/> French |
| <input type="checkbox"/> SALESMANSHIP | <input type="checkbox"/> Auto Repairing <input type="checkbox"/> Italian |

Name _____
Occupation & Employer _____
Street _____
and No. _____
City _____ State _____

ELECTRICAL LOSSES IN TRANSMITTING AND RECEIVING SETS.

(Continued from page 702.)

frequent source of trouble. Ground connection should be made to moist earth only. If the earth around the station be sandy and dry, a counterpoise ground may be resorted to. This is made by stretching a wire netting similar, if possible, in shape and dimensions to the antenna just above the ground and insulated from it. The netting should be placed directly under the antenna to secure best results. Such a ground is used for military portable stations with very satisfactory results.

(To be continued.)

HOW TO ORGANIZE AND CONDUCT A RADIO CLUB.

(Continued from page 699.)

fecting himself alone. A member has a right to change his vote, if not by ballot, before the final result is announced, but not afterward.

ORDER IN DEBATE.

When a person wishes to speak he must rise in his seat, address himself to the chair, who must recognize him by name, thus giving him permission to speak. If several should arise at the same time the chairman must signify who shall speak first. No member should be allowed to speak more than twice, except to give a mere explanation, without special leave of the house, and the time a speaker may hold the floor is unlimited unless there is some rule of the organization limiting the speakers. If the chair rises to speak, the person standing must sit down until the chair has finished. In referring to another member it should not be by his name, but as "the previous speaker," "my opponent" or some such descriptive phrase. When a member is called to order he should sit down and not attempt to speak again until he has permission from the chair.

ORDER OF EXERCISE.

After an organization is effected the order of exercises adopted depends upon what is best suited for that body's deliberation. 2. Roll call. 3. Reading, approval, correction and adoption of the minutes of previous meeting. 4. Reports of standing committees. 5. Reports of special committees. 6. Unfinished business. 7. New business. 8. Communications. 9. Orders of the day. 10. Election of officers. 11. Reception of new members. 12. Announcements. 13. Adjournment.

PARLIAMENTARY DON'TS.

Don't attempt to discuss a motion until it has been stated by the chair.

Don't antagonize unnecessarily; nobody loves a barking dog even if he doesn't bite.

Don't be carried away in debate by a fervor or frenzy; moderation will win your cause most surely with reasonable minds, and your opinion will carry more weight. Speak slowly and distinctly.

Don't be too exacting to have the letter of the law enforced.

Don't forget that the common laws of politeness and respect due your fellow man obtain just the same in the society hall as in the drawing-room, even if the by-laws of the organization have no definite ruling on these points.

Don't cheapen your opinion in the eyes of others by speaking too often or upon every occasion. Keep quiet until you have something to say and a good reason for saying it.

Preface a motion with "I move that."

Don't leave it to the chairman to handle a motion relating especially to himself. The secretary or maker of the motion should state the question, put it to vote and announce the result.

(Continued on page 730.)

SOLDERALL

TRADE MARK



Price
50c.

50 MENDS for REAL METAL SOLDER
50 CENTS

With an ordinary match it easily mends and stops all leaks in pots, pans, tinware, metal ornaments, agate ware, toys, umbrellas (broken ribs) and a hundred other things. Automobileists, mechanics and machinists use it regularly. Indispensable for wiring. A child can stop or mend a leak with it at once.

SOLDERALL

TRADE MARK

Blow Torch

FITS ANY POCKET

No pumping or blowing necessary. Generates its own pressure. Burns wood or denatured alcohol. It is absolutely **safe**. Can't Explode.

PRICE, \$1.00

Dealers write for Wholesale Price List

THE EMENAR CO., Inc.
45 E. 23d ST., NEW YORK



Electric "Pullers" for Boys

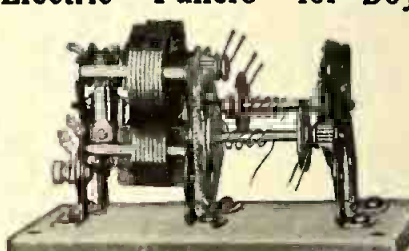

No. 390

Just what they have been looking for. Transfers the high speed to great power at slow speed.

FIVE CHANGES

from three pulleys and two winding drums.
Price \$2.00

Live dealers everywhere. Order direct, or ask your dealer to show you the Knapp Line and insist on getting Knapp Goods. Dealers not already handling the Knapp Line should ask for prices.

Catalog illustrating many specialties on request.

KNAPP ELECTRIC NOVELTY CO.
523 West 51st St., N. Y. City

BUILD YOUR OWN

Grandfather's Clock

WITH OUR HELP

We furnish blueprints, finishing material and instructions. Buy the works, dial, weights and pendulum from us at surprisingly low prices. You make a fine profit building artistic clocks for your friends. Complete works, \$5.00. Others with chimes at all prices. Ask for attractive free offer.

Clock Company
1661 Ruffner St.
PHILADELPHIA, PA.



BOSTON WIRELESS

Rotary Condenser, 43 plates, .001 M.F., \$3.75
Tuner, \$2.50. Spark Gaps, 60c. and \$1.00
Detectors, \$1.00, \$1.75, \$4.00
Loose Coupler, \$7.50, 1500 Meters

Agent for A. W. Bowman & Co., Adams-Morgan Co. Manhattan Spark Coils. Catalogue for 2c. stamp.

M. MUELLER, 18 Devonshire Street, BOSTON, MASS

PATENT ADVICE

Edited by H. GERNSBACK

In this Department we will publish such matter as is of interest to inventors and particularly to those who are in doubt as to certain Patent Phases. Questions addressed to "Patent Advice" cannot be answered by mail. Sketches and descriptions must be clear and explicit. Only one side of sheet should be written on.

WIRELESS DEVICES.

(50.) L. H. G. submits several ideas regarding rotary spark gap, quenched spark gap, hot-wire ammeter, and wishes to have our advice. He also wishes to know if, in case the devices are patentable, they could be sold for a reasonable sum without first obtaining a patent.

Our correspondent has an idea to increase the efficiency of a quenched spark gap by inclosing the entire gap in a certain gas, and wants to know if this would increase the efficiency of the gap.

A. A quenched gap will not work as well when inclosed in gas, for the reason that it will not be air-cooled as well as if it were under ordinary atmospheric pressure. For that reason it would work less efficiently.

On his rotary variable condenser a certain number of circular plates are mounted on two horizontal insulated rods. More or less plates can be placed in the circuit.

A. We do not see anything new in this condenser, as a similar one is already on the market, and the difference in the construction is not great enough to warrant your obtaining a patent.

As to the hot-wire ammeter, we believe its construction to be faulty, and we doubt if a patent can be obtained. As to the other question, we would never advise anyone to sell or offer for sale an invention without having first applied for a patent on same. It is a risky thing to do, and the inventor frequently loses the title to his invention.

EMPLOYEES' INVENTIONS.

(51.) C. J. Conner, Coatesville, Pa., wishes advice on the following:

Can an employer, whether a corporation or individual, claim an invention made by one of his employes and patented by said employe, the latter not using the time or material of the employer when developing the invention, and further, the employe paying for the patent.

A. If the invention has not been developed on the premises of the employer he has no right to the patent, if obtained by the employe. Only by working on the employer's premises, using his tools and equipment, etc., can an employer actually claim title to an employe's invention. We would suggest that you write to a patent attorney and obtain detailed information on the matter.

NON-OXIDIZING CONTACT.

(52.) W. Rademaker, Hoboken, N. J., wishes advice on the following questions:

1. Having applied for patents on an absolutely water-dust-rust-fire-etc.,-proof nonoxidizing and unexplosive contact or circuit breaker, what would be, according to your opinion, its commercial value or field of application?

A. 1. It is impossible to say what the commercial value of the contact of this kind would be without knowing the composition of it. Just by having a contact fire-proof means nothing, as some contacts are used under a very great heating stress where even platinum, which has a very high melting point, wears away in time. Tungsten

is being used, as it has a very high melting point, but it is not very suitable on account of its being too brittle.

2. Are exposed circuit-making devices, such as rail, fire-alarm signals, bells outside, frequently inoperative on account of atmospheric influence, ice, sleet, etc.?

A. 2. Yes.

3. Are there any contacts on the market which work by a sliding member in an airtight space?

A. 3. To our knowledge there are quite a few such contacts on the market. We believe the idea is a common one.

NEW DETECTOR.

(53.) Carter Pietsch, Bloomington, Ill., submits a new scheme for a wireless detector which is supposed to operate by using certain metallic members and certain magnetic windings surrounding these members. Our correspondent wants to know if this detector will work, also if it is patentable. He also would like to know who the most reliable patent attorney is to whom he might submit the idea.

A. Without trying out a scheme of this kind it is wholly impossible to say offhand whether it would work or not. Would advise our correspondent to have a sample made up and tested, and if it works we think a patent can be obtained, for the idea is rather novel. As to patent attorneys, any patent attorney advertising in this magazine can be trusted implicitly.

LOOSE COUPLER.

(54.) Oscar Taman, Chicago, Ill., submits drawing and specifications of a new long-wave loose coupler, and means are provided to entirely eliminate the dead end effect on long waves. Several moving tubes with wire are used in order to accomplish this. Inquirer desires to know whether his idea is patentable.

A. A loose coupler similar to the one you show is already on the market, and we do not think a patent could be obtained on your design.

Give the same thoughtful attention to the other fellow's ideas that you would have him give to yours, for in that way you not only learn more, but make more friends while you are about it.

PATENTS

IF YOU HAVE AN INVENTION which you wish to patent you can write fully and freely to Munn & Co. for advice in regard to the best way of obtaining protection. Please send sketches or a model of your invention, and a description of the device, explaining its operation.

All communications are strictly confidential. Our vast practice, extending over a period of seventy years, enables us in many cases to advise in regard to patentability without any expense to the client. Our Handbook on Patents is sent free on request. This explains our methods, terms, etc., in regard to Patents, Trade Marks, Foreign Patents, etc.

All patents secured through us are described without cost to the patentee in the *Scientific American*.

MUNN & CO.

SOLICITORS OF PATENTS

699 WOOLWORTH BLDG., NEW YORK
and 625 F STREET, WASHINGTON, D. C.

PATENT YOUR IDEAS
There is a Constant Demand for Good Inventions



"WHAT TO INVENT"
and "How to Obtain a Patent"
These Books sent FREE

If you have an invention, send sketch for free report regarding patentability; if not, send for free book, "What to Invent."

From our advertisements in newspapers manufacturers are constantly writing to us regarding the purchase of patents. Their names and addresses are furnished our clients free of charge. We advertise your patents for sale at our expense. **DON'T WAIT!** Your invention will never do you any good if some one else patents it ahead of you. Write to us NOW.

CHANDLEE & CHANDLEE
Est. 20 years. 822 F Street, Washington, D. C.

PATENTS

THAT PROTECT AND PAY Books and Advice Free

Send sketch or model for search. Highest References. Best Results. Promptness Assured.
WATSON E. COLEMAN, Patent Lawyer
624 F. Street, N. W. Washington, D. C.

INVENT SOMETHING

It May Bring Wealth

Our Free Book tells what to invent and how to obtain a patent through Our New Credit System.
WATERS & CO., 4287 Warder Building, Washington, D. C.

PATENTS WANTED

Write for List of Patent Buyers who desire to purchase patents and What To Invent with valuable list of Inventions Wanted. \$1,000,000 in prizes offered for inventions. Send model or sketch for Free Opinion as to patentability. We have a Special Department devoted to Electrical Inventions and are in a position to assist and advise inventors in this field in the development of their inventions.

MODERATE FEES—WE ASSIST INVENTORS TO SELL THEIR PATENTS

Write To-Day for our Five Books sent free to any address. (See attached coupon:)

-----FREE COUPON!-----
VICTOR J. EVANS & CO., Patent Attorneys
NEW YORK OFFICES: 189-191 Broadway PHILADELPHIA OFFICES: 1429 Chestnut St.
Main Offices: 779 9th Street, N. W., WASHINGTON, D. C.
GENTLEMEN: Please send me FREE OF CHARGE your FIVE Books as per offer.

NAME ADDRESS

You benefit by mentioning "The Electrical Experimenter" when writing to advertisers.



MILLERS FALLS TOOLS

When you Experiment
or build things—or do odd jobs round the house you need a good bit brace to do good work.

MILLERS FALLS BIT BRACE No. 732

has a ball bearing head and dust protected ratchet.
A "holdall" chuck holds all sizes of bit stocks and round shanks from 1/8 to 1/2 inch.
It's reasonable in price, too.
Send for pocket catalog.

MILLERS FALLS CO.
"Toolmaker to Master Mechanics"
Millers Falls, Mass.
N. Y. OFFICE: 28 Warren St.

HOW TO ORGANIZE A RADIO CLUB.
(Continued from page 728.)

THE CLUB LIBRARY.

While we do not wish to go on record as saying that books will teach everything, and further that we thoroughly believe in having every member of amateur clubs do some practical work with apparatus owned by the club or build some special instrument under the instruction of the club's instructor or engineer, yet we do wish to say that there is nothing more important for any such organization, whether large or small, than a good library. It may consist of six books or a hundred. At any rate, shortly after the club has been started on its mission the idea of forming a library should be promulgated and brought before the members. Besides books, a very important source of information is the magazines and periodicals available on the subject. These should be subscribed for at once, so that one or more copies will come to the reading table of the club each month.

The *Electrical Experimenter* is the leading wireless journal available to-day, and the following should also be subscribed for whenever possible: *Wireless World*, published by the Marconi Press Agency, Marconi House, Strand, London, W. C., England; *The Electrical World*, published by the McGraw-Hill Publishing Co., 239 West Thirty-ninth street, New York City, which very often publishes excellent engineering articles covering radio telegraphic developments of vital importance and interest to all live radio amateurs and operators.

The manager of the Radio League of America will be glad to advise anyone interested in this work as to where the best books, as well as the most reasonably priced ones, can be obtained on the subject of radio telegraphy and its allied branches. We give below a brief list covering the more important books on wireless furnished prepaid by the book department of *The Electrical Experimenter*.

- LIST OF RADIO CLUB LIBRARY BOOKS.
- Operator's Wireless Telegraph and Telephone Handbook. By Victor H. Laughter \$1.00
 - Wireless Telegraphy and Telephony Simply Explained. By Alfred P. Morgan 1.00
 - Elementary Manual of Radio Telegraphy. By Dr. J. A. Fleming 2.25
 - The Design and Construction of Induction Coils. By Frederick Collins. Principles of Wireless Telegraphy. By Dr. George W. Pierce 3.00
 - The Principles of Electric Wave Telegraphy. By Dr. J. A. Fleming.... 7.50
 - Wireless Telegraphy. By Dr. J. Zenneck 4.00
 - Experimental Wireless Stations. By P. Edelman 1.50
 - Wireless Telegraphy and Telephony. By C. J. Hoppough 1.50
 - Manual of Wireless Telegraphy for Naval Electricians. By Lieut.-Commander S. S. Robinson, U. S. N... 1.50
 - Practical Uses of the Wave Meter in Wireless Telegraphy. By Lieut. J. O. Mauborgne, U. S. A. 1.00
 - Wireless Telegraphy and High Frequency Electricity. By H. La V. Twining, A.B. 1.50
 - Electricity at High Pressures and Frequencies. By Henry L. Trans-trom 2.00
 - Experiments with Alternating Currents of High Potential and High Frequency. By Dr. Nikola Tesla.. 1.00
 - The Book of Wireless. By A. Frederick Collins 1.15
 - Construction of Induction Coils and Transformers. By Thomas Stan-

2 H.P. \$35

Auto Throttle Governed Engine for Every Work

There is no other four-cycle engine with automatic type of throttle governor on the market near the price. Unlike ordinary low priced engines it is not hit-or-miss—a while governed with irregular speed and wasted gasoline.

It fires every shot with speed regulated by exclusive auto-throttle governor which means even, economical power. It will operate electric light plant, pump water, run evaporator, churn or freezer, chop feed, operate machinery, in fact, it is "the engine for every work."

Hopper cooled complete ready to run, 2 H. P., for only \$35. Direct to you from the factory. Write for catalog.

C. Benninghofen & Sons
Dept. 110, Hamilton, O.



PORCELAIN

"THAT'S OUR BUSINESS"

Standard and Special Shapes, Regardless of How Difficult

We illustrate one hard shape we make. A pair of rolls 7 1/2" long and 1 1/4" in diameter with 8 holes on ends and middle. They must be perfectly straight and we make them so. It's hard but not for us. We can make your difficult designs also. Send us blue print for quotations.

Union Electrical Porcelain Works
TRENTON, N. J.



GROBET SWISS FILES

Are the standard of excellence in files, and have been for over 100 years. We send postpaid as an inducement 48 files especially adapted for tool makers and machinists on receipt of \$5.00. This is a chance to get a set of files you'll appreciate and we'll get future orders.

MONTGOMERY & CO.
100 Fulton Street
New York City



Experimental and Model Work

ELECTRICAL INSTRUMENTS AND FINE MACHINERY

Inventions developed. Special Tools. Dies, Gear Cutting, Etc.

HENRY ZUHR
32-34 Frankfort Street
New York City

600% Profit in Battery Charging

Every Auto starter and lighting battery needs a full charge outside the car once in two months. There are big profits in this work if properly equipped to handle. No special skill or attention required. **BATTERY SERVICE BRINGS YOU NEW CUSTOMERS.** Sold on small monthly rents. Write us.

HOBART BROS., Box B, TROY, OHIO



Model and Experimental Work

Special Tools, Small Machinery, Electrical Apparatus and Inventions Developed

CHAS. SPLINTER
200 N. JEFFERSON STREET, CHICAGO, ILL.

Theres' a Book
You Need on Page 738:
LOOK FOR IT.

WE TEACH WIRELESS BY MAIL

You May Learn Theory, Code and Laws of Radio Communication in Our School or at Your Home, fitting you for positions paying good salaries with wonderful chance to travel the world over. It's the most interesting profession known and the demand for skilled operators is increasing. Send stamp for catalog which gives full information.

NATIONAL RADIO SCHOOL, 4405 U St. Washington, D. C.

PATENTS Manufacturers **BUY** Patents that FULLY Protect—are the kind we get. Proof and reliable books free. LACEYS Patent Lawyers, 731 Barrister Bldg., Washington, D. C.

REGISTERED PATENT ATTORNEYS
PATENTS AND TRADE MARKS

LANCASTER & ALLWINE

252 Ouray Bldg. Washington, D. C.
Book "Inventions—Patenting and Promoting" Free
Improvements wanted—Send for free bulletins & advice



INVENTORS WANTING **FOREIGN PATENTS**

at 1-2 rate and U. S. priority proof filed. EX (gov) FEE by Inventors' League of U. S. expert att'y, get our latest terms. BUREAU of Patents, 11 Broadway, New York.

WE SHOW HOW TO SELL YOUR PATENT

EXPERIMENTERS—INVENTORS

Let us develop your inventions and make your working models. Our well equipped shop and staff of experienced model builders are at your service. We carry a complete stock of gears. Shipment made same day order received. Send 4c in stamps for booklet Inventors' Supplies.

UNION MODEL WORKS, Established 1882
119 S. Clark St., Chicago



BRASS GEARS cut by an entirely new process. The most accurate made and at prices that cannot be equalled by others. Every gear has a hub, center painted ebony black, edge turned true, highest grade red brass, and much heavier than others. We carry the largest stock in the world, and every gear listed is always shipped on date of order. SEND FOR CATALOGUE

CHICAGO STOCK GEAR WORKS
20a So. Fifth Ave. Chicago



Icy Curtis 25
 Wireless Hook-ups 25
 How to Make Wireless Receiving Apparatus 25
 How to Make Wireless Sending Apparatus 25

REVISED LIST OF AMATEUR RADIO CLUBS.

- (Addition to list published in March issue.)
 Arlington Radio Club, Arlington High School, Arlington, Mass. Secretary, Harold O. Bixby, 65 Hillside avenue, Arlington, Mass.
 Graceland Wireless Club, Graceland College, Lamoni, Iowa. Secretary, Jesse Roth, Graceland College, Lamoni, Iowa.
 Inter-City Radio Association, Allentown, Pa. Secretary, William J. Kreis, 623 N. Penn street, Allentown, Pa.
 Iowa City High School Radio Club, Iowa City, Ia. Secretary, Alan C. Rockwood, 1011 Woodlawn avenue, Iowa City, Ia.
 Lewiston Radio Club, High School Building, Lewiston, Idaho. Secretary, George Barrett, 925 Eighth avenue, Lewiston, Idaho.
 Louisville Radio Club, Louisville, Ky. Secretary, H. D. Brailsford, 323 W. Broadway, Louisville, Ky.
 Oklahoma Radio Experimental Association, 1109 N. Francis Street, Oklahoma City, Okla. Secretary, Clifford A. Smith, 922 1/2 W. Main street, Oklahoma City.
 Peoria Radio Club, Peoria, Ill. Secretary, Ronald Mooberry, 915 Sanford street, Peoria, Ill.
 Scott High School Radio Club, Scott High School, Toledo, O. Secretary, Watson Snell, 2555 Scottwood avenue, Toledo, O.
 Society of Radio Research, Atlanta, Ga. Secretary, A. B. Corey, 379 N. Jackson street, Atlanta, Ga.
 St. Louis Radio Club, St. Louis, Mo. Secretary, Fred Best, 4104 Easton avenue, St. Louis, Mo.
 Two Hundred Meter Club, Newtonville, Mass. Secretary, Herbert Hovendon, 42 Austin street, Newtonville, Mass.
 U. of W. Radio Club, University of Washington, Seattle, Wash. Secretary, F. M. Ryan, 4524 University boulevard, Seattle, Wash.
 Waco High School Radio Club, Waco, Tex. Secretary, Paul M. Doby, 535 Proctor street, Waco, Tex.
- Notice: To ensure proper entry of club registrations in our revised monthly list be sure to send us at once the data outlined below. Such information should reach us not later than the 28th of the month for entry in the succeeding issue of THE ELECTRICAL EXPERIMENTER.
- Name of Club.....
 Location (street and city).....
 Founded.....
 No. of Members.....
 Meeting Date.....
 Power of Club Set, if any.....
 Call Letter (licensed?).....
 Dues and Initiation Fee.....
 Secretary's Name and Address.....

BOOK REVIEW.

SELF HELPS FOR THE CITIZEN SOLDIER. By Capt. James A. Moss and Capt. Merch B. Stewart. Cloth covers, 240 pages, profusely illustrated. Published by George Banta Publishing Co., Menasha, Wis. Price, \$1.25.

"We must depend in every time of national peril in the future as in the past, not upon a standing army, nor yet upon a reserve army, but upon a citizenry trained and accustomed to arms."

These words from President Wilson in his message, December, 1914, convey the thought of every thinking leader from Washington down to the present day. The present book is directly in line with such principles, and although it does not teach the citizen to be a soldier, it gives him information on the rudiments of what is required of soldiers, and by intelligent reading, he can clearly understand his duties and will fit smoothly into the military scheme.

The subject of our deficient defense receives attention in the forepart of the book, from which it goes on to explain the duties of a soldier. The book is well illustrated with photographs of soldiers in camp, on duty and at play. Pen pictures are used to caricature some false ideas and give the proper touch of light matter that relieves the seriousness of the book, yet brings home its importance in a very vivid manner.

Rules of hygiene and health are suggested to harden the citizen; full details of the National Rifle Association of America are given, as well as the rules under which arms and ammunition may be obtained without cost for rifle practice.

The planning and carrying out of a battle are described to impress upon the mind of the reader the importance of every man doing his best at all times, and how really important each cog is in a perfect machine.

The volume is written with a high ideal in mind by men who are working toward those ideals, and its true value may never be realized till the cessation of the present war leaves us rich, yet unprotected, while the foreign coun-

You Ought to Have the Best Flashlight

When you are coming home late at night, or working around the house and need a light, you want a light that will stay lit and won't start fires.

FRANCO Flashlights with Radio Batteries are definitely guaranteed for service; beautifully finished and reasonably priced. For Safety Sake, insist on

FRANCO
 Awarded GOLD MEDAL



Flashlights
 Panama-Pacific Exposition

See the complete line at your dealer's or write us for catalog No. 9—FREE.

INTERSTATE ELECTRIC NOVELTY CO.
 29 Park Place, New York

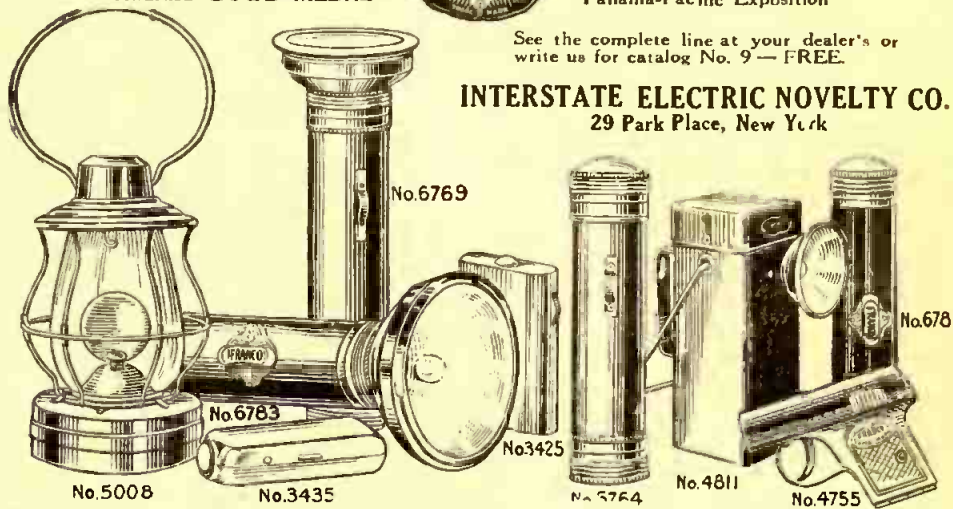

You Can Only secure the best in FLASHLIGHTS and BATTERIES by insisting that



"Cigarette"

this trade-mark is on flashlight-case and battery. If your dealer cannot supply you with our product write directly to us for Catalogue A2.



Beacon Flashlights and Batteries are made in a wide variety of styles and shapes but only one quality—THE BEST.



"Short-Circuit Proof."



"Ideal Fountain Light."

Beacon Electric Works of National Carbon Co., 130-132 KING STREET NEW YORK
 BRANCHES: CHICAGO, SAN FRANCISCO

Arnold Navy Type Loose Coupler
 PRICE, \$15.00

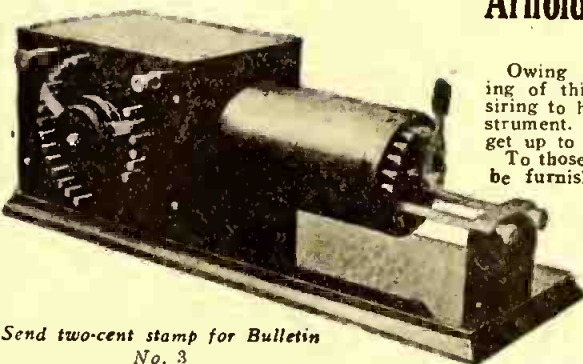

Send two-cent stamp for Bulletin No. 3

Owing to the peculiar construction and winding of this instrument it is possible for those desiring to hear the Arc Stations, to do so on this instrument. A special Hook-up is needed in order to get up to the wave length.

To those ordering an instrument such Hook-up will be furnished gratis.

It is as in the past the Right instrument to do all first class receiving with Workmanship and material the best.

Send 2-cent stamp for Bulletin No. 3, which describes fully, also shows the finest line of Switch points, Rubber knobs and accessories on the Market.

J. F. ARNOLD
 135 East 119th Street, New York City

EXPERIMENTERS! ATTENTION!

Make your own generator or motor. We have a full line of all parts, finished or unfinished. We make a specialty of commutators and armature discs. We have a nice line of sturdy little generators from 80 watt to 800 watt, just the thing for charging storage batteries, for private lighting plants. Any capacity storage battery.

ALL AT FACTORY PRICES

BERNARD M. BERGMANN, Send Stamp For Circular "B" For Quotations 442 Niagara St., Buffalo, N. Y.

Here's **YOUR** Chance to Learn
DRAFTING
This Complete \$15 Drawing
Outfit and Full Instructions
In Mechanical Drawing **FREE**



There's a good job waiting for you. The country is facing greater prosperity than it has ever before experienced. Far-seeing men are getting ready for boom times. Get this training now and share in the coming prosperity. We make the way plain.



CHARLES W. MOREY
President of the College
and Head of a Large Chicago
Firm of Civil, Mechanical
and Electrical Engineers and
Contractors.

**Men Wanted
AT BIG SALARIES**

This is a rare chance for a few wide-awake young men. On account of the rapidly increasing demand for trained draftsmen Pres. Morey has issued orders that instructions be furnished to a limited number of young men who are inclined along engineering or architectural lines. Read about this great offer below—then mark and mail the coupon.

STUDY AT HOME Devote your spare hours for a short time only and learn this profitable and pleasant profession, and get in the class drawing the big pay envelope. Hundreds of men are in daily attendance at this old established college. In your own home you can do the same work these men are doing, and the same experts that teach them will guide you toward the big job. These well-known engineers prepare your instruction matter. Your work is examined and approved by them. They know exactly the practical training you need and they train you. No books to sell. Live, up-to-date blue prints of work in actual construction. In your own home you work with plans of machinery, buildings, steel works, etc., actually being constructed in Chicago, New York and other large cities.

Electrical Drafting and Design
No other similar correspondence course in America has a resident college of National reputation back of it, nor a faculty of active experts actually engaged in municipal and corporation engineering work. These men know exactly the kind of training you need because they are in constant charge of big work.

\$45 COURSE FREE
IN MECHANICAL DRAWING

This College has set aside a limited number of Free Scholarships and will give the regular \$45 Course in Mechanical Drawing Free with any one of the Home Study Courses named in the coupon below—this is in addition to the complete \$15 Drawing Outfit which is also furnished to students free. Take advantage of this unusually liberal offer today, as it will be withdrawn when the allotted number of Free Scholarships has been awarded. It costs you nothing to get full information. No obligation on you.

ACT NOW—FILL OUT COUPON TODAY

| | |
|---------------------------|-----------------------|
| —Electrical Drafting | —Builders' Course |
| —Machine Drafting | —Plan Reading |
| —Architectural Drafting | —Estimating |
| —Structural Drafting | —Sheet Metal Drafting |
| —Civil Engineering (1060) | —Surveying |

Name

Address

Town State

College or Home Study Course

CHICAGO TECHNICAL COLLEGE
1060 LAKE VIEW BLDG. CHICAGO, ILL.

tries will be poor and in debt, but equipped with a mighty war machine that can only be met with men who handle a rifle as well as they do a cane.
The Radio League of America was formed with a similar idea of preparedness in mind. This book will be of great service to members of the League who realize their duty to the country in time of peril, enabling them to grasp clearly the part they will have to play in the mighty drama of war, should this harbinger of sorrow ever visit our fair land. It is a step in the right direction and the only criticism is that many more and interesting details might be incorporated in its make-up.

THE ELEMENTARY PRINCIPLES OF WIRELESS TELEGRAPHY. By R. D. Bangay. Cloth covers; 7 3/8 x 5 inches; 155 pages; 86 illustrations. The Marconi Publishing Corporation, New York City. Price, 35 cents.

Amateurs, as a class, have been waiting for such a book. It contains no "how-to-make-it" or construction data on apparatus, but confines itself to a clear and lucid explanation of high frequency phenomena in its relation to wireless telegraphy.
The reader will marvel at the ease with which the writer takes him through the book, explaining the operation of the different apparatus used in a manner not made tiresome by repetitions, useless words or flights of fancy so often indulged in to make a book imposing.
The elementary phenomena of electricity and magnetism is dealt with but only in so much as it refers to the subject on hand, and the student quickly picks up the theory of the art.
All of the apparatus used at the present time is explained in language that is concise and untechnical.

HANDBOOK OF TECHNICAL INSTRUCTION FOR WIRELESS TELEGRAPHISTS. By J. C. Hawkhead; revised by H. M. Dowsett, A.M.I. E.E. Cloth covers; 5 3/4 x 7 3/4 inches; 295 pages; 242 illustrations. The Marconi Publishing Corporation, New York City. Price, \$1.50.

The vast number of Marconi stations on ship-board and the many recent improvements in same has made necessary a revision of this work as originally written by Mr. J. C. Hawkhead. The aim of this treatise is to put into the hands of the ship radio operator a book that will be of assistance in giving him a solid foundation on which to base phenomena noted in practical work.
The suggestions incorporated in the book are not only of use to the commercial operator but could be followed with profit by amateurs interested in having up-to-date and efficient stations.
All types of apparatus used by the Marconi Co. are portrayed and explained, both the care and operation up to and including the multiple type tuners and 5 K. W. transmitting sets.
Quite a large amount of space is allotted to the explanation of elementary electricity, thereby forming a solid basis for other information included in the work.

LIST OF RADIO STATIONS OF THE WORLD. By F. A. Hart and H. M. Short. 220 pages; 8 3/4 x 5 1/2 inches; cloth bound; 35c. Supplied by The Experimenter Publishing Co., New York City.

This book is divided into four parts and arranged so any operator may easily and quickly locate the call of any station desired, or on the other hand, just as easily determine the name and position of any station sending a call that is heard through a wireless set.
The first part lists all radio stations of the world, land and ship, alphabetically by their calls and this list is corrected up to May, 1915. By means of this list it is possible to trace any call to the station of its origin.
The second part lists naval stations alphabetically by country and vessel, while part three lists commercial ship stations by vessels, giving owner, nationality and control.
The last section contains a list of coast stations, arranged alphabetically by country and station.
The book is printed on high-grade paper in large, easily read, type and is a valuable addition to any radio station, commercial or amateur. Being practically indispensable when accurate data is required for calls heard or stations that are to be communicated with, and still within the reach of every one, it should find a ready demand.

X-RAY INDISPENSABLE.
Electricity is extensively used in modern surgery. Indeed, it would be difficult to get along without it. Without the X-ray machine it would be impossible to accurately locate foreign substance in the body. X-ray photos are also extensively used in diagnosing a large number of other ailments, such as tumors and cancers.

We Guarantee First Grade Commercial Operators' Licenses

The Largest, Best Equipped and ONLY Practical Radio School in New England

LEARN WIRELESS
Last year every one of our graduates successfully passed his required commercial Government Examination upon the first trial. Send a stamp for new fall prospectus. Winter classes now forming.
Eastern Radio Institute
899 B. Boylston St., Boston, Mass.

START NOW
LEARN TELEGRAPHY and WIRELESS
Students who start now reap the advantages of the wonderful opportunities created by the war and which will multiply when peace is declared.
Our book on "Telegraphy and Wireless as an Occupation" sent on receipt of 10c. It gives much necessary and valuable information.
BOSTON SCHOOL OF TELEGRAPHY
18 Boylston St., Boston, Mass.

\$4.50 Starts YOU Towards the Big Job
The profession of Meter Engineering needs Men. Positions are open. Big Money is being paid. Now—on a great special offer—you can start for the big job for only \$4.50. Be the boss—Be the man who gets the fat pay envelope. Don't delay.
Write Today for Big New Book Your name & address, that is all. No obligation. Big opportunities for men in our profession.
Ft. Wayne Correspondence School, Dept. 3384 Ft. Wayne, Ind.

DON'T TAKE A COURSE IN MACHINE DRAFTING
till you've read my proposition. You want to learn the kind of drafting that enables you to earn money. I can prove by numerous references that my course is best. No picture books for children, but a business proposition for business young men! Instruments I send free are guaranteed best furnished by any concern. Terms very reasonable. Pay a part after in position as draftsman. Mention "The Experimenter," and inclose stamp, and I will send a copy of "Straight Dope," a set of engineering tables.
MACHINE DRAFTSMAN, 252-254 S. CORONA, DENVER, COLO.

Learn Wireless Telegraphy. There is an ever increasing demand for competent operators—this profession offers steady employment, at a good salary—wireless operators travel all over the world.
The PAINE UPTOWN BUSINESS SCHOOL
1931 Broadway, (65th) New York. Send for Catalogue E.

ELECTRICAL ENGINEERING
men with training are always in demand. Having trained over 2000 young men in the past 23 years in the fundamentals of Applied Electricity, The Paine Electrical School, with its well-equipped shops and laboratories, is peculiarly well qualified to give a condensed course in Electrical Engineering
including Mathematics, Steam and Gas Engines, Mechanical Drawing, Shop Work, and Theoretical and Practical Electricity, in all branches. Students actually construct dynamo, install wiring and test efficiency of electrical machinery. Course, with diploma, complete
IN ONE YEAR
For practical young men with limited time. 24th year opens Sept. 27th. Catalogue on request. 260 Takoma Ave., Washington, D. C.

500 TYPEWRITERS AT \$10 TO \$15
Typewriter prices smashed! Underwoods, Remingtons, Royals, L. C. Smiths, Fox, etc.—your choice of any standard factory rebuilt machine at a bargain. Everyone perfect and guaranteed for three years including all repairs. My free circular tells how to save 40 per cent to 60 per cent on each machine.
Write for it. C. E. GAERTE, President
DEARBORN TYPEWRITER EXCHANGE, DEPT. 624, CHICAGO, ILLINOIS

THE CHEMISTRY OF THE STORAGE BATTERY.

(Continued from page 711.)

either in the plates themselves or in the electrolyte, these normal reactions may be departed from. The impurities which may damage a battery are of three kinds:

IMPURITIES.

First—Foreign metals, or salts of such metals, especially such as are less electro-negative than lead, i. e., copper, silver and platinum. They are immediately precipitated on the negative plate and form, with the negative active material, innumerable points at which local action takes place. The spongy lead is, by this action, converted into lead sulphate, free hydrogen gas being evolved at the foreign metal. This action is greater the greater the quantity of metallic impurity and the more readily hydrogen gas is thrown off its surface. Platinum is the worst of the metals in this respect. A familiar example of this action is the following: Chemically pure zinc is but very slowly attacked in dilute sulphuric acid. On the addition of a mere trace of copper sulphate, copper is precipitated on the zinc, creating local action, and the zinc is violently attacked with the evolution of free hydrogen gas.

Second—Metals such as iron or manganese, whose salts are readily oxidized or reduced. Iron or ferrous sulphate is, for example, readily oxidized to ferric sulphate in contact with lead peroxide, while the ferric sulphate is again reduced to ferrous sulphate in contact with the spongy lead, each of these actions being accompanied with loss of charge of the corresponding plate and the formation of lead sulphate. A considerable quantity of iron or manganese will rapidly discharge a battery in this way.

Third—Foreign acids or salts of these acids or acid-forming substances. The effect of these substances is a rapid corrosion of the grids. The presence of such acids, even in minute quantity, must be avoided.

It is on account of the above actions that care should be taken to use only such acid and water as are known to be pure.

PUPIN'S NEW NON-INTERFERENCE ANTENNA.

(Continued from page 701.)

quency higher than a given range of frequencies. The station becomes then an ear which is quite sensitive for frequencies which are in the vicinity of the signaling frequency, but which is stone deaf to frequencies which are considerably beyond the range, as most static disturbances are. Similarly, a sectional wave conductor can be constructed which is quite responsive to frequencies in the vicinity of the signaling frequency, but absorbs almost completely everything below this range. My theoretical and experimental investigations encourage me in the belief that a perfect barrier has been found against disturbances due to the so-called static, and that the distances of uninterrupted wireless telegraphy and telephony will be very greatly increased.

RECTIFICATION NOTICE.

We are advised by Casimir Jaroszewicz, who recently submitted a contribution for the monthly station contest in the February, 1916, issue of *The Electrical Experimenter*, that the radio set there described over his name is owned by Harold Burbridge, 6109 South Green street, Chicago, for which party Mr. Jaroszewicz prepared the article.

A Continuous and Cheap Service of ELECTRIC LIGHT In Your Country Home, Hotel, Club, Church Institution or Small Town



You simply switch on or off your lights and the **BRUSTON PLANT**

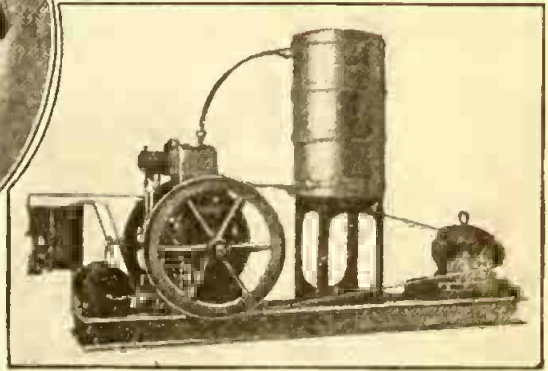

Starts Itself and Stops Itself

OVER 1,000 IN USE

THE BRUSTON AUTOMATIC ELECTRIC LIGHTING PLANT gives you the same continuous service of light and power in your country home, hotel or institution as you have in the City of New York.

The plant is absolutely automatic, starts itself, regulates itself and stops itself. Practically the only attention required being to fill the fuel and oil tanks.

It will generate current at less than half what it would cost you in the city.

This plant has obtained the highest awards at the leading expositions in England, Canada and France, has been installed in the houses of many of the leading people of the world and has never been replaced by another plant or taken out as unsatisfactory.

Send for catalogue "X" or call at our office and see a plant in actual operation

BRUSTON AUTOMATIC ELECTRIC LIGHTING & POWER CO., Inc.
126 Liberty Street Telephone, Rector 9354 New York City

ELECTRICAL ENGINEERS Earn \$125 to \$250 a Month

The demand for Electrical Engineers at \$125 to \$250 a month far exceeds the supply. Engineering and power companies everywhere are searching for specially trained men. No previous experience necessary to take up this interesting work. Decide to fit yourself for one of these high-salaried positions.

The **American School** will train you to be a well-paid electrical worker in a short time at small expense. Our staff of practical engineers will give you individual instruction and advice. You can start in right now to prepare yourself for a better job and bigger pay.

Earn While Learning

No need to give up your present occupation. We train you at home—solely by correspondence—as we have successfully trained thousands of others in the past eighteen years. Pocket-size textbooks, prepared by famous electrical experts, enable you to study anywhere—at any time. Papers examined and corrected only by experienced technical graduates.

Electrical Book FREE

Send the coupon for your copy of our 56-page Free Book. Tells how easy it is to master Electricity, and gives full particulars regarding the course you are most interested in. **Don't hold back because of the money. The cost is small, and you can pay for your instruction as you progress—in small monthly installments.**

Mark and mail the coupon to-day. This is a wonderful opportunity to get into a profession that pays big money. No obligation in sending the coupon. **Mail It now!**

AMERICAN SCHOOL OF CORRESPONDENCE, CHICAGO, U. S. A.

\$800 to \$2,400 in Three Years
"The work I did with you advanced my salary from \$800 to \$2,400 in three years."—RUDOLPH F. KOOPS, Rochester, Mass. (Graduate, Electrical Engineering.)

Made Chief Electrician
"About two months ago I was appointed Chief Electrician of the Schenectady plant of the American Locomotive Co."—L. A. WARREN, JR., Schenectady, N. Y. (Graduate, Electrical Engineering.)

Free Book Coupon

AMERICAN SCHOOL OF CORRESPONDENCE, Chicago, U. S. A.

Without any obligation on my part, please send me your Free Book and complete information regarding a course in Electrical Engineering Telephone Engineering Hydroelectrical Engineering Power House Superintendence Wireless Telegraphy. Elec. Exper. 4-16

NAME _____

ADDRESS _____

LET SAM BROWN TEACH YOU THE AUTOMOBILE BUSINESS

He'll fit you for a good job as chauffeur, testor, repair man, salesman, etc., in 3 to 5 weeks. Sam teaches you personally—is right on the job every minute. Established six years.

Earn \$75 to \$300 a Month

Good jobs everywhere are waiting for good men. Complete equipment to work on; 4, 6 and 8 cylinder cars for students' work. No theory. Sam is practical. Short on lectures—long on actual, practical work. When you finish you are ready to tackle any auto problem. You're as good as the best. Sam does a good job. Learn from a practical mechanic. I have a fine 8 story building, at 1513-21 Prospect Ave., and 1520-26 Brownwell Court. Welding and Bronzing Depts.; large, well equipped machins shop; Radiator, Fender and Tire Depts. Start in at once. Drop in and see me, or write—Sam Brown.

Ohio Auto School
Dept. 201, 1521 Prospect Ave.
CLEVELAND, O.

PLATING QUARTZ FIBERS BY A CATHODE SPRAY.

The construction of many sensitive electrical instruments necessitates having a conducting support which shall be very light, besides having a constant torsion. This usually takes the form of a quartz fiber and many schemes have been used to render this substance a conductor, among which can be mentioned the method of spraying metallic particles on the fiber proper by mechanical means and also by electroplating platinum on the fiber.

Advantage was taken of the cathode discharge noticed in connection with Crookes' tubes in devising a new method of plating quartz fibers, which requires more or less extensive apparatus, but the illustration herewith gives a good idea of the process. An aluminum or glass tube is shown at A which has a rather thick wall. In the bottom is sealed a pipe P which is attached to a vacuum pump of any desired type, but it must be powerful enough to create a high vacuum in the chamber. The plug B in the upper end is ground into its seat to make an air-tight joint, and vaseline is used to seal this joint. The center of the plug is hard rubber surrounded by a ring of brass,

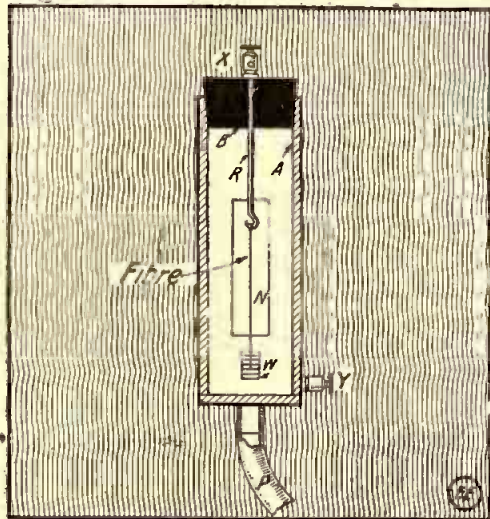

Apparatus Used to Plate Quartz Fibers by a Cathode Spray.

while through the center of it passes the rod R. Supported from the lower end of the rod R is the fiber which is to be plated with platinum. This fiber is kept taut by the weight W. At N is shown a sheet of the platinum foil which is fastened to the side of the cylinder if the tube is of aluminum. Should the tube be made of glass a platinum wire is sealed into the glass to make connection to the foil.

In operation the device acts in the following manner: Hydrogen is admitted to the chamber and the vacuum pump is then started, which creates a rarefied atmosphere of hydrogen. The terminal X in the plug is connected to the positive pole of the induction coil or transformer and the terminal Y is connected to the negative pole. When the coil is in operation according to the phenomenon taking place in a Crookes' tube the cathode rays will be thrown off from the tube toward the center. If the tube is made of aluminum there will be very little, if any, aluminum deposited on the fiber, whereas the platinum foil will have fine particles torn off and forcibly deposited on the quartz.

It is advisable to turn the plug at frequent intervals, so that all sides of the fiber will be acted upon by the platinum. This turning of the plug may be eliminated by coating the entire inner surface of the cylinder with platinum, but this makes the apparatus much more expensive to construct.

The resulting film of platinum on the fiber will be found to be very coherent, thin and of comparatively low resistance.

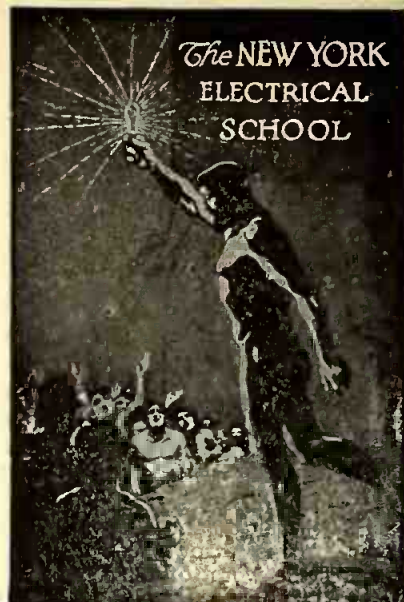

The NEW YORK ELECTRICAL SCHOOL is the pioneer and premier school of the "Learn by Doing" method. When you have completed this Course you shall be fully qualified to handle ALL branches of Electrical industry. The equipment of this School is unequalled and up-to-the-minute. No preparation needed to become a "learner" in this school. You can start to learn on any day of any week throughout the whole year. Send for catalogue.

New York Electrical School
29 West 17th Street New York City

Practical Electrical EDUCATION

Our practical course in Electrical Science and Engineering trains you to get and keep the big-pay jobs. Enter at any time, no matter what your education. Advance as fast as you master what we teach. Course combines theory with actual practice in all branches of electrical work. Individual instruction. Positions paying \$1,500 a year up, waiting for graduates. WRITE FOR FREE ILLUSTRATED CATALOG.



HOME STUDY COURSE—If you cannot come to us or do not want to give up your present occupation, we will furnish you, by mail, at small cost, our theoretical course. Will apply all payments made for Home Study Course on regular tuition; in case you enter our school at Milwaukee later. Get full particulars. **SCHOOL OF ENGINEERING OF MILWAUKEE** 238 Stroh Building, Milwaukee, Wis.

New 1916 Edition of "Experimental Wireless Stations" by Philip E. Edelman

Now ready. Enlarged to 272 pages with new illustrations

Greatest offer in wireless books. Only volume that is up to date for 1916. Contains all the 1914 edition and, in addition, gives full information on Audion Amplifiers, Pilot, Cascade Amplifiers, Audion Oscillator and Ultraudion. Receiving set for long wave and undamped wave reception. Tuners and couplers of all sizes up to 14,000 meters, circuit used for transcontinental telephony from Arlington, Va. Railroad, Automobile and Aeroplane Wireless. Latest information on receiving time and weather signals. Dimensions of aerials for all wave lengths. Wireless Compass, Heterodyne Receiver. Use of Crystal Detector with Audion, etc. Tells how to receive 4,000 miles with a small aerial, about ground aerials, dead-end switches, telemechanics with audion circuits instead of coherers. How to find the trouble when a set won't work. Lieben-Reisz Amplifier, etc.

This 1916 edition contains a complete classified list of all the U. S. Patents granted for wireless telegraphy, telephony, and control from the beginning to date, together with a discussion of the more important recent patents. This gives the key to the entire art and no experimenter can afford to be without it. This book has the highest recommendations of radio engineers, wireless experts, radio inspectors, wireless associations and operators.

Owing to large increase in size and expense, a higher price is contemplated, but on orders received immediately, the new 1916 edition will be supplied at the previous low price of only \$1.50. If you have the old edition you will want the new. NOW!

Send \$1.50 and 15c. postage at once. Book will be sent by return mail. Satisfaction guaranteed.

P. E. EDELMAN Publisher 1802 Hague Ave. St. Paul, Minn.

Learn to **PAINT SIGNS and SHOW CARDS** I'll teach you personally by mail. 17 years' successful teaching. Big field for men and women. You can **EARN \$18 to \$45 A WEEK** Davis (N. C.) says: "Have been paid 50 fold. Couldn't make a letter. Now do all card writing for my firm." **DETROIT SCHOOL OF LETTERING** Chas. J. Strong, Founder Dept. 3704, Detroit, Mich.

Learn Piano Better & Faster

Obtain free book showing how **QUINN WRITTEN METHOD** saves three-quarters of time and money usually necessary to learn piano or organ. Scientific and systematic method, yet practical and simple. Play chords immediately, and a complete piece within a few lessons. Successfully used by Dr. Quinn for over 25 years. Endorsed by leading musicians. Successful graduates everywhere. Learn at home either as a social accomplishment or for teaching. Practice in spare time whenever you wish. For either adults or children. Special terms this month. Send today for **FREE** book "How to Learn Piano and Organ." No obligation. **M. L. QUINN CONSERVATORY**, Box 650-DO, CHICAGO.

LEARN the AUTO BUSINESS

Earn a Splendid Salary or Have a Business of Your Own. The Auto business is growing by leaps and bounds; there are better opportunities now than ever before, for properly trained men as Chauffeurs, Demonstrators, Mechanical Experts, etc. Over 3,000 of our graduates are making good money. Most Up-to-Dates—12 Years of Success. Latest equipment including 8 and 12 cyl. cars; latest types motors and lighting and starting systems. Individual instruction. Tuition and Board reasonable. Write at once. **CLEVELAND AUTOMOBILE SCHOOL** 2343 Euclid Ave. CLEVELAND, O.

MUSIC LESSONS FREE

You can read Music like this quickly. At Your Home. Write today for our booklet. I. tells how to learn to play Piano, Organ, Violin, Mandolin, Guitar, Banjo, etc. Beginners or advanced pupils. **AMERICAN SCHOOL OF MUSIC**, 70 Lakeside Bldg., Chicago

Uncle Sam is a Good Boss

He pays good money and the jobs are pleasant, dignified and good for a lifetime. Why not try for a good government job? The examinations are not hard to pass if you let the International Correspondence Schools show you how. Write today for booklet which tells how hundreds have got positions. It's free and without obligation. **International Correspondence School** Box 5308, Boranton, Pa.

Succeed Through Electricity

This interesting story shows you the way to greater success in the Electrical Field.

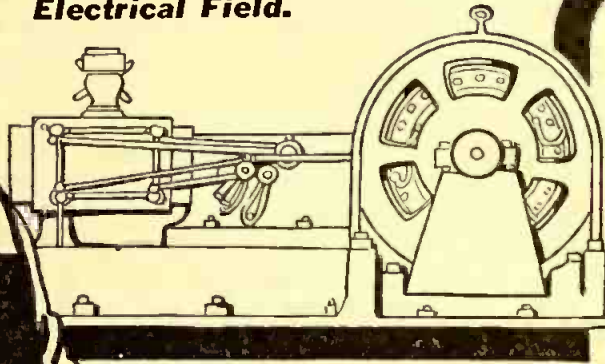

This is the Electrical age. Electricity now controls more trades, directs more men, offers more opportunities than any other power that man has yet discovered. Through exact knowledge of Electricity you will advance in salary and position.

Read These Testimonials

"Any Electrician, Operating Engineer, or Student who wants to do his own construction or further advance himself in the Electrical field should have a set of these books."

JOHN KELLEY
116 Union St., Newark, O.

"For the man not getting a college training and even in that case, I can sincerely say I do not believe there is a better set of books in the market today."

LLOYD D. HUFFMAN
Dayton, O.

"We consider Hawkins Electrical Guides the most compact and complete set of electrical references in the market."

NOGGLE ELECTRIC WORKS
Monterey, Cal.

"Hawkins surely knows the art of condensing information."

ELBRIDGE F. BALL
Buckland, Conn.

Hawkins Electrical Guides Will Show You How

These books are the standard works on Electrical Science. They are a complete and up-to-date course in Electrical Engineering, presenting the information in a way you can use it. Only \$1.00 per volume and owners of the set say there are no better electrical books published at any price.

Specially Arranged for Home Study and Reference They fit your pocket and your pocket book. Beautifully bound in flexible black leather with gold edges. Easy to read and handle. You can carry each single volume about with you until you have mastered the subject it contains. Written in the form of questions you would ask and the answers to them — in plain, practical, everyday language, complete, concise, authentic and to the point. Over 3200 pages and more than 4,000 illustrations.

10 NUMBERS IN ALL

1⁰⁰
A Number
PAYABLE

1⁰⁰
A Month

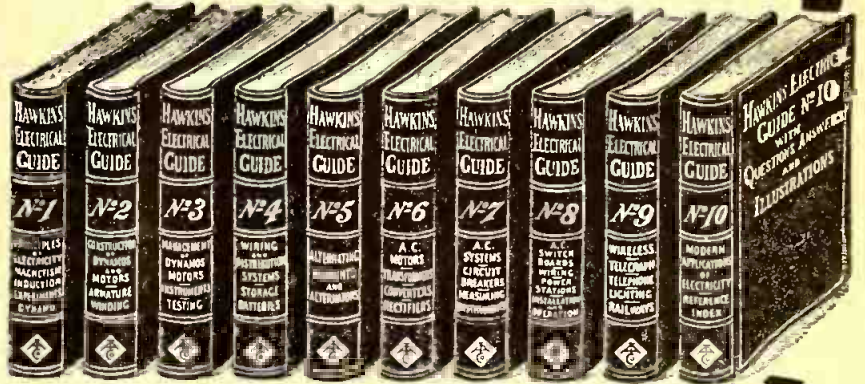

Shipped to You FREE

YOUR FREE COUPON

Send no money. Examine the books first. Decide for yourself that they are the most complete library of Electricity ever published and that you cannot afford to be without them. Every book is complete in itself, but the complete set is the best bargain. The last volumes are just coming off the press. Eight numbers now ready.

Easy Payments Accept this unusual offer now — today. Each page—every illustration will convince you of the big value we are offering. See the books first, then decide. If you decide to keep them you can make settlement at only \$1.00 monthly until paid for.

Theo. Audel & Co.
72 Fifth Ave., N. Y.
Please send me for FREE examination Hawkins Electrical Guides (Price \$1.00 each). Ship at once prepaid the first eight numbers. If satisfactory I agree to send you \$1.00 each month until paid.

A FEW OF THE SUBJECTS
Magnetism—Induction—Experiments—Dynamometers—Electric Machinery—Motors—Armatures—Armature Windings—Installing of Dynamometers—Electric Instrument Testing—Practical Management of Dynamometers and Motors—Distribution Systems—Wiring—Wiring Diagrams—Sign Flashers—Storage Batteries—Principles of Alternating Currents and Alternators—Alternating Current Motors—Transformers—Converters—Rectifiers—Alternating Current Systems—Circuit Breakers—Measuring Instruments—Switch Boards—Wiring—Power Stations—Installing—Telephone—Telegraph—Wireless—Bells—Lighting—Railways. Also many Modern Practical Applications of Electricity and Ready Reference Index of the 10 numbers.

Theo. Audel & Co.
72 Fifth Ave.
NEW YORK

Signature
Occupation
Business Address
Residence



BEST RESULTS
obtained with
MARKO
STORAGE
BATTERIES
for Audion use

It is a well-known fact among up-to-date wireless engineers and experimenters that the Audion operates at a higher efficiency when controlled by a storage battery that gives constant voltage. Marko Batteries are designed to meet these conditions.

Guaranteed highest quality and lowest prices.
Some Popular Sizes.

| Type | Volts | Amb. H.R. Capacity | List Price | Net Price |
|--------|-------|--------------------|------------|-----------|
| 4 WT 4 | 4 | 40-60 | \$10.50 | \$7.87 |
| 6 WT 2 | 6 | 20-40 | 11.00 | 8.25 |

Descriptive Circular upon request.

PAUL M. MARKO, 1191 Bedford Ave., Brooklyn, N.Y.

MARVELS OF MODERN PHYSICS.

(Continued from page 698.)

region of the ultra-violet than in that of the infra-red. These are the waves which often prove harmful to the eyes, but on the other hand their great germicidal power has been successfully harnessed by a Danish physician, Finsen, who achieved remarkable success in the treatment of skin diseases and cancer with them. In medical circles the name *Finsen Rays* has been given to the ultra-violet rays used by him.

The production of ultra-violet light is simple. The ordinary arc light is rich in it, but as ordinary glass cuts off these rays, the globe is generally made of quartz.

So far we have said nothing about the X-ray or the invisible radiations given off by radio-active substances, because this is where we come in contact with the other great class of invisible radiations, consisting of fine, rapid-moving particles of matter, and it was long a mooted point as to which class X-rays themselves belonged.

The Crookes' tube was one of the first vacuum tubes to be used in connection with electric discharges. It consisted of a bulb-shaped tube and two electrodes, as in Fig. 3. Plücker discovered the fact that certain rays were given off at the cathode, and these were found to be minute particles having a *negative* electric charge. Later Goldstein discovered the canal rays, or rays given off at the anode, which travel much slower and are *positively* charged. Not until 1895 did Röntgen discover that still other rays were given off at the anode, and on account of their unknown character he termed them the *X-rays*. On account of the fact that they could neither be refracted, reflected nor polarized he thought them to be different in nature from light waves. It is known now, however, that ether waves may be either periodic trains of waves or irregular pulses, very short, and that irregular pulses may not necessarily be subjected to the laws governing ordinary periodic trains. Consequently it seems quite well established that the X-rays are very short, irregular, transverse disturbances in the ether caused by the electrons bombarding the positive target in the tube. It is further thought that the X-rays, on account of their length, should be placed about the ninth octave above the visible spectrum.

As for the radio-active substances, of which uranium is one of the most active, the invisible radiations are quite similar to those of the X-ray tube. These emanations were originally called Becquerel rays, after the scientist who first noticed them. However, instead of one, there are three distinct kinds of rays, known as the alpha, beta and gamma rays (α , β , γ). These *alpha rays* consist of a stream of positive particles, while the *beta rays*, which are more penetrating, are identical with the cathode rays mentioned before. The *gamma rays* are extremely penetrating, and appear to be quite similar to X-rays.

Thus it is seen that the invisible radiations of the radio-active substances are composite. The remarkable feature is that they originate spontaneously and that though they may be given off for a long period of time the action does not seem to materially decrease. In order to aid in distinguishing between the different rays they are shown diagrammatically in Fig. 4.

One more interesting phenomenon in connection with invisible radiation is the property of certain substances known as *fluorescence*. Such substances are really light transformers; that is, they transform invisible waves to such lengths that they are visible. Beautiful color effects can be obtained by throwing ultra-violet light on such substances.

One of the most important results of the present-day study of invisible radiations is the bearing these results have on our theories of the ultimate constitution of matter. In the case of radio-active substances the atoms are unstable and the radiation goes on at the expense of the internal energy of the atom. The question arises, why should these atoms be so unstable? Is it an electrical phenomenon?

And we are, of course, brought again to the problem of the electro-magnetic wave. Experiments of the past year seem to indicate that the X-rays themselves may be reflected, refracted and partially polarized, and this develops still further the idea of the similar nature of all ether waves, although there still remain several striking differences between X-rays and light rays.

The development of the electron theory of matter has largely been an outgrowth of research in radiation. We know that the velocities of the alpha, beta and gamma rays are widely different, the speed of the first being about 20,000 miles per second,

(Continued on page 737.)

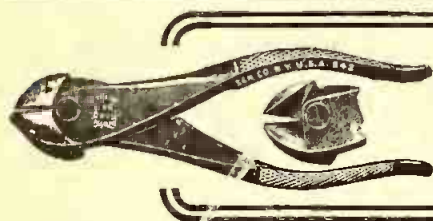

Cuts the toughest wire with the least strain
"RED DEVIL" NIPPER No. 542-6"

1 lb. handle pressure gives 20 lbs. cutting pressure. Hand-honed, "stay sharp" cutting edges, slip-proof, scientifically shaped handles. Sample 85c postpaid.
MECHANIC'S TOOL BOOK FREE

SMITH & HEMENWAY CO., Inc. 153 Chambers st. New York City

MEN WE HAVE TAUGHT ARE NOW SAILING THE SEVEN SEAS!

LEARN RADIO, COMMERCIAL OR RAILROAD TELEGRAPHY

BEREL'S SCHOOL OF TELEGRAPHY, 343-345 LENOX AVE. (127TH ST.), NEW YORK CITY

5 DAYS A WEEK—5 EVENINGS A WEEK—OPEN ALL YEAR—START AT ANY TIME

DAYS, \$7.50 A MO.—EVE., \$5.00 A MO.—FREE TRIAL ATTENDANCE

SEND FOR FURTHER PARTICULARS—NO CONNECTION WITH ANY OTHER SCHOOL

S-T-O-P!

We hereby present the greatest bargain ever offered in electrical literature.

A complete volume of the *Electrical Experimenter* bound in rich, dark green linen, stamped with gold letters at the extraordinary low price of

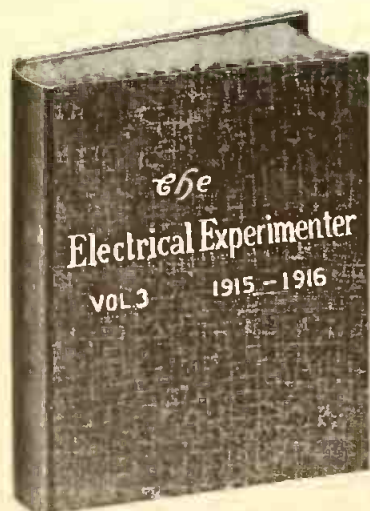

\$1.25

Postage on 7 lbs. is extra

Volume contains twelve numbers, 743 pages, 1,226 complete articles, 1,742 illustrations, 227 questions and answers.

A world of electrical information; the entire electrical progress for one year; the greatest reference book on current "Wireless"—all at a price as low as the *unbound*

copies would bring. Mind you, the book is durably bound with heavy covers. You will be proud to have it in your library. We have only 300 copies, therefore be sure and order to-day. Shipping weight 7 lbs. Add a sufficient amount for postage. Ready for delivery April 15th.

Order today to avoid delay

EXPERIMENTER PUBLISHING COMPANY, Inc.

Book Department, 233 Fulton Street, New York, N. Y.

LIGHTNING, ITS EFFECTS AND HOW TO AVOID THEM.

(Continued from page 683.)

thing like sharp bends around cornices and projections.

The number of conductors necessary depends on the size of the building and the comparative heights of its structural parts.

There is no special area below an elevated rod which can be considered as actually protected; so that "area of protection" really cannot be defined, and no definite rule can be laid down as to the number of rods necessary to protect a building.

The consideration of the extent of protection afforded must bear some relation to the value and importance of the building concerned. It should be the practise to provide at least two or more rods on any building. The best known system of protection is that referred to before.

It should be noted that any chimney stack is liable to be struck; each, therefore, should have its own elevation rod connected to the nearest conductor leading to earth.

Special attention should be paid to kitchen chimneys, as a column of hot air will often be selected as a path for the flash. The earth connection should be made either by means of a copper plate buried in damp earth, or by the tubular earth system, or by connection to the water mains. The number of connections should be in proportion to the ground area of the building, and there are few structures where less than two are necessary; if it is thought desirable to use the modified "bird-cage" system, described heretofore, each side of the building should have its own earth. Church spires, high towers, factory chimneys, etc., having two ground conductors should have two earths, which may be interconnected.

If a copper plate is used it should not be of less than 3 sq. ft. in area and not less than 1/8 inch thick, rectangular in shape, with saw-tooth edges and surrounded with broken coke or graphite. If coke is used, it must be thoroughly washed to eliminate any sulphur which may destroy the copper. The conductor should be firmly attached so as to make a permanent mechanical and electrical joint.

MARVELS OF MODERN PHYSICS.

(Continued from page 736.)

the second 100,000 miles per second, and the third 180,000 miles per second.

This is a step toward the solution of the riddle of modern physics, which resolves itself into the question as to what is the finite nature of positive and negative particles and electro-magnetic waves.

[This is the third paper of a series prepared especially for The Electrical Experimenter by Mr. Rusk.—Editor.]

A 500,000-VOLT TESTING TRANSFORMER.

The Oerlikon (Switzerland) Works regularly manufactures testing transformers giving voltages of 200,000 and 250,000. For use in their own laboratories they have found it necessary to construct a transformer yielding in normal operation a difference of potential of 500,000 volts. The exterior shape of the apparatus is cylindrical, 3.3 meters in diameter and 3.6 meters high. Its total weight is 34 tons. It is capable of taking a current of 1,000 amperes at 500 volts. At 500,000 volts the sparking distance is 1.32 meters, and at its maximum overload, giving a voltage of 700,000, the sparking distance is 1.85 meters.



DO YOU

own a wireless station, either for sending or receiving? If you do, don't fail to join the greatest Wireless Association in the country: THE RADIO LEAGUE OF AMERICA. If you believe in the preparedness of your country, if you

wish to help Uncle Sam, if you wish to have your station officially recognized, join the LEAGUE, a national, non-money-making organization. Beautiful engraved and sealed certificate, FREE to all members. NO DUES OR FEES WHATSOEVER.

Honorary Members: W. H. G. BULLARD, U. S. N.; PROF. REGINALD A. FESSENDEN; DR. LEE DE FOREST; DR. NICOLA TESLA.

Send stamp for large 8-page information booklet. DO IT NOW.



This Great Electrical Library SENT FREE FOR EXAMINATION

Send today for your free-for-examination set of the greatest electrical reference library of modern times. The new 1916 edition, just off the press, is recognized by big men in the electrical field as the most practical work of its kind ever published. Covers completely the generation and use of electricity for power, light, transportation and communication, including the construction and operation of dynamos and motors, central station engineering and telephone work, as well as wireless telegraphy and telephony and land and submarine telegraphy. Particularly helpful in its exhaustive treatment of electrical "troubles" and their remedies.

Earn \$150 to \$250 Monthly Electrical Engineers earn from \$150 to \$250 a month. The work is pleasant—the hours short. These great books will fit you—in your spare time—to enter this fascinating, high-salaried work. No previous experience necessary.

Cyclopedia of Applied Electricity

Contains 3,500 pages, 7x10 inches; 3,000 illustrations, full page plates, diagrams, etc.; hundreds of valuable tables and formulas; carefully cross-indexed for quick, easy reference. The books are substantially bound in half red morocco, gold stamped, and are printed in large, clear type on special quality paper.

50c a week The complete seven volumes, not a sample volume, will be sent, express prepaid, for seven days' free examination; returnable at our expense if they fail to meet with your expectations. If you keep them, pay \$2 seven days after receipt and then \$2 a month until you have paid the special introductory price of \$19.80, saving \$15.20, as the regular edition is \$35.00. As this offer is for immediate acceptance only, fill in and mail the coupon today. It won't cost you a cent to examine these books, so get them into your home, shop or office and look them over at your leisure. Remember, if you don't like them they may be returned at our expense and you won't be out a penny. One of the most liberal offers ever made. You can't afford to pass it by.

What These Books Cover
Elements of Electricity—Electrical Measurements—Underwriter's Electrical Requirements—Theory, Calculation, Design and Construction of Direct Current Generators and Motors—Types of Generators and Motors—Management of Electrical Machinery—Electric Lighting—Alternating Current Machinery—Power Transmission—Electric Railways—Self-Propelled Railway Cars—Trackless Trolleys—Power Stations—Switchboards and Switching—Storage Batteries—Applied Electrochemistry—Electric Elevators—Electric Welding and Heating—Wireless Telegraphy and Telephony—Land and Submarine Telegraphy.

Consulting Service Free With every set is included absolutely free a year's Consulting Membership, regular value \$12, entitling you to the advice of a staff of electrical experts. These men are no further from you than your nearest mail box. They stand ready to solve your perplexing problems, to offer suggestions, to point out the things you should avoid. Absolutely no limit to their assistance—ask as many questions as you wish for a whole year. This service alone will be worth more to you than the entire cost of the books.

Don't wait. This means \$15.20 saved if you act now. Remember, you take no chances whatever—it costs nothing to inspect and you are nothing out if you do not care to buy. This offer may mean your success, so mail the coupon today—now—before you turn the page.

American Technical Society, Chicago, U. S. A.

FREE COUPON Worth \$15.20 to you
American Technical Society Chicago, U. S. A.
Please send me Cyclopedia of Applied Electricity for seven days' free examination. If I keep the books, will send \$2 within seven days and \$2 a month until \$19.80 has been paid, when \$35 books and \$12 consulting membership will be nine. Otherwise will notify you and hold books subject to your order. Title not to pass until fully paid.
Elec. Exper. 4-16
NAME
ADDRESS
As I have had no previous dealings with you refer you to

You Can Get Better Results

BY USING THESE WONDERFUL BOOKS



How to Make Wireless Sending Apparatus

This book will surely be welcomed by every wireless enthusiast, and by the one who is fond of making his own apparatus. This book contains more information on how to make sending apparatus than any other book we know of. Thirty different pieces of apparatus can be made with materials that most anyone can obtain without much trouble and illustrations and descriptions are so clear and simple that no trouble will be experienced in making the instruments.

Only strictly modern and up-to-date apparatus are described in this book, and if we asked you 50¢ for it, we are sure that you would think it a bargain. This book has been written by twenty radio experts who know how to make wireless sending apparatus and for that reason you profit by their experience as well as by their experiments.

Among others, this book contains the following important apparatus: How-to-Make an Experimental Arc Set, How-to-Make a Speaking Arc Light, How-to-Make a Quenched Spark Gap, How-to-Make a $\frac{1}{4}$ K. W. Transformer, How-to-Make an Oscillation Transformer, How-to-Make a Radio Break in System, How-to-Make a Photophone, How-to-Make a Rotary Spark Gap, How-to-Make an Independent Vibrator, How-to-Make a Calibrated Spark Gap, and many others.

Size of the book is 7 x 5 inches, substantially bound in paper; the cover being printed in two colors. There are 100 pages and 88 illustrations. There are quite a few full-page illustrations giving all dimensions as well as photographs showing finished apparatus. **25c**

How to Make Wireless Sending Apparatus, **PREPAID**

How to Make Wireless Receiving Apparatus

This book will surely be a boon to every "how-to-make-it" fiend. It has been written and published entirely for the wireless enthusiast who makes his own receiving apparatus and the twenty radio constructors who have written the articles are well-seasoned in the art and know whereof they speak. Consequently, you profit by their experience.

Only strictly up-to-date and modern apparatus are described and only those that the average experimenter can make himself, with material that can be readily obtained. We believe that **this book contains more information on how to make a wireless receiving apparatus than any other book in print** and you will find that it is easily worth double the price we are asking for it.

Among the many good articles, the following will be of particular interest: How-to-Make a Receiving Set Without Aerial or Ground, How-to-Build a Magnetic Detector, How-to-Make a Wireless Relay, How-to-Make a Wireless Lecture Set, Intensifying Radio Signals, Construction of an Improved Loose Coupler, How-to-Make a Conical Tuning Coil, Construction of an Interference Preventer, How-to-Make a Unique Receiving Transformer, Construction of an Efficient Wave Meter, How-to-Make a Pocket Wireless Set, etc., etc.

Size of the book is 7 x 5 inches, handsomely bound in paper; the cover being printed in two colors. There are 100 pages and 90 illustrations. There are quite a few full-page illustrations giving all dimensions as well as quite a few photographs showing the finished apparatus. **25c**

How to Make Wireless Receiving Apparatus, **PREPAID**



Thousands of dollars were gladly spent to compile this book NOW OFFERED to you for the unusual price of **35c** Postage on 1 lb. extra

CONTENTS

Tells you quickly and accurately either call letter or station name and location of **any and every wireless station in the entire World**. Obviates that irritating moment when you hear an unknown call and have no means of quickly knowing who it is. Makes it worth while sitting up late at night to hear that faint and far off foreign call, for with it, at least, you can tell whom you hear. **Contains 222 pages of information worth its weight in gold**, lists over 15,000 ship and shore stations by **BOTH** nationality, location and call letter being cross indexed to give location, ownership and station designation.

A REALLY REMARKABLE OFFER

Imagine a finely cloth bound book $5\frac{1}{2}$ x $8\frac{1}{2}$ inches and $\frac{1}{4}$ inch thick in size, containing 222 pages of information obtainable nowhere else and printed on an excellent grade of book paper and from type unusual for clearness and ease of reading. Not only is it up to date, but provides means for the insertion in their proper places of **new calls of every nationality** whenever assigned. Positively the best work of its kind ever offered and **WORTH \$2.00 PER COPY**.

HOW IT IS POSSIBLE

This remarkable offer is possible only because of the financial difficulties which prevented the publishers from marketing a book which cost them thousands of dollars to compile alone, while thousands more were spent in editing, composition, printing and binding. Being exhausted the printers came to us as the logical outlet and we offer you these books at a price less than they actually cost to produce.

AUTHORS

The book was compiled by **FRANK A. HART**, Chief Inspector of The Marconi Wireless Telegraph Co., of America, and **H. M. SHORT**, resident inspector (U. S. A.), Marconi International Marine Communication Co., Ltd. Need we say more as to the authority which these men have at their command to compile so noteworthy and necessary a book?

DELIVERY

We have on hand a very limited number only of these books and **NO REPRINTS WILL BE MADE**. We cannot, therefore, urge too strongly that you send in your order at once. All orders will be filled in the order of their receipt. Better send for it **TO-DAY** and make sure of getting the greatest book value possible to get. When you get the book you will say we've underestimated the value we offer.

NOTE! POSTAGE IS EXTRA ON A SHIPPING WEIGHT OF ONE POUND. So include sufficient postage with your remittance which should be in cash or by money order.

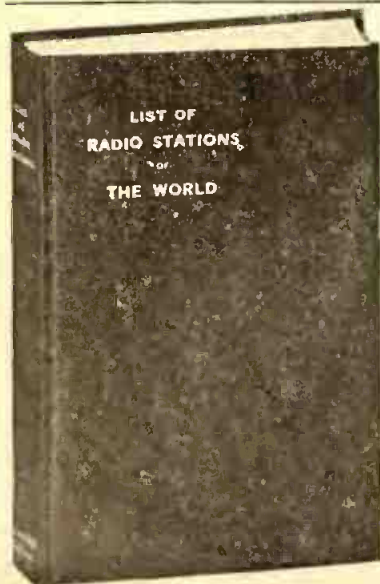

EXPERIMENTER PUBLISHING COMPANY, Inc., BOOK DEPARTMENT, 233 Fulton Street, New York, N. Y.

ELECTRICITY KILLS PROMINENT WIRELESS MAN.

On Feb. 4 last Virgil J. Simpson, one of the foremost wireless men of St. Louis, Mo., met his death in the radio laboratory of the Christian Brothers College of that city.

Mr. Simpson had gone to the laboratory to conduct a radio test on a new 5-kilowatt transformer of his own design and which he had just completed. He proceeded to check up the calculations by connecting a step-down potential transformer to the secondary terminal of the large step-up transformer, which latter yielded 10,000 volts. The voltmeter was connected across the low potential or primary winding of the small potential transformer usually employed for such voltmeter readings. The accident happened while he was attempting to disconnect the test instrument from the larger apparatus, forgetting for a moment that he had not opened the main primary switch connected with the 10,000 volt transformer.

The 10,000 volt current, although of not very heavy amperage, passed through his body for some seconds before he managed to jerk away one of the leads. A companion rushed to his aid and reached his side just as the victim freed himself from the charged wire. They walked to the middle of the laboratory, but the shock had been too much for him and he collapsed. Physicians were immediately summoned and worked over him for about an hour with a pulmotor, but to no avail.

His death should be a caution to all electricians, and particularly to those in the radio field, never to attempt to make connections in high tension transformer circuits until the primary circuits are opened. A moment's carelessness, as in the case of Mr. Simpson, may spell death.

A PECULIAR ELECTRICAL ACCIDENT.

An odd electrical accident is reported in a technical paper "Safety in Stone Quarry" recently issued by the Bureau of Mines, Washington, D. C. A transformer supplying a stone quarry burned out, permitting 4,000 volts to pass to the hoisting motors. The man in charge placed his hand on the lever and as the machine was electrically charged he could not let go. As he was wearing rubber-soled shoes he sustained no injury. He called for help and the man who came to his assistance, instead of pulling the switch and cutting off the current, took hold of the engineer's hands and tried to pull them free and in doing completed the circuit. The man with the rubber-soled shoes was unharmed except for slight burns.

Twenty per cent. of the people use electricity in some way every day. Most of us get it in some form during the

A NEW INSULATED CONNECTOR.

In the past the most troublesome thing about wiring has been the soldering of joints. It was very crude; in fact, soldering is one of the oldest known methods of making electrical joints and has not been improved on in any way except in the appliances used.



The new connector here pictured fills a long felt want and the connecting of wires is easily and quickly done. As will be seen from the illustration, it consists of a shell with this new instrument of hard

rubber on which is mounted a thumb screw with a conical point, which fits into a cone-shaped head. The wires to be connected are twisted together and inserted in the hole at the left, then the screw is forced down by means of a pair of pliers or a screwdriver clamping the wires tightly. The resulting joint is perfect, both mechanically and electrically.

The advantage of this very clever connector will be appreciated when the number of accidents that it will eliminate are considered. With the old methods fire was often caused from the alcohol or gasoline used in the torch, damage was done by hot solder falling on furniture, etc., and the soldering acid splashing on various things.

How I Jumped from \$1500 to \$50,000 Yearly



"Power of Will" Was My Guide

"Three years ago I was making \$1500 a year and working day and night. Today I make a thousand dollars a week and have time for other things as well. To the lessons in 'Power of Will' more than any other thing do I owe this sudden rise."

These are the exact words of an owner of "Power of Will." His name is not published for obvious reasons, but will be gladly given in confidence on request.

As remarkable as is his experience it might also be called typical of what this wonderful course in Will Training is doing for thousands of men and women in every walk of life who are using "Power of Will" as the stepping stone to greater accomplishment.

What is "Will Power"?

The Will is the motive power of the brain. Without a highly trained inflexible will, a man has about as much chance of obtaining success in life as a railway engine has of crossing the continent without steam. The biggest ideas have no value without Will Power to "put them over." Yet the Will, hitherto entirely neglected, can be trained into wonderful power like the brain or memory and by the very same method, by intelligent exercise and use.

If you held your arm in a sling for two years, it would become powerless to lift a feather, from lack of use. The same is true of the will—it becomes useless from lack of practice. Because we don't use our wills—because we continually bow to circumstance, we become unable to assert ourselves. What our wills need is practice.

"Power of Will"

by FRANK CHANNING HADDOCK, Ph. D., a scientist whose name ranks with such leaders of thought as James, Bergson and Royce, is the first thorough course in Will Power ever conceived. It is the result of over 20 years of research and study. Yet you will find every page in the 28 lessons written so simply that anyone can understand them and put the principles, methods and rules into practice at once with noticeable results right from the very start.

Meant for You

There are over 75,000 people in all walks of life who own "Power of Will." Among them are such master men as Judge Ben B. Lindsey; Supreme Court Justice Parker; Wu Ting Fang, ex-U. S. Chinese Ambassador; Lieut.-Gov. McKelvie of Nebraska; Assistant Postmaster-General Britt; General Manager Christeson of Wells-Fargo Express Company; E. St. Elmo Lewis, now Vice-Pres. Art Metal Construction Company, Gov. Ferris of Michigan, and many others of equal prominence.

Never in the history of self-help literature has there been such a record. And the owners regard it as a veritable text book. It has been instrumental in changing the entire lives of thousands—making them dominant personalities, self-confident and eager, in place of the fearful, unhappy, unsuccessful men and women they formerly were. No matter what your position—whether an errand boy or the president of a mighty corporation—no matter what your age, from 17 to 70, Power of Will can change your whole life—can make a new man of you just as it has for so many others. Whatever you want in life is yours, be it money, power, prestige or happiness, if you but master the wonderful system of will training taught in "Power of Will."



Send No Money!

Although "Power of Will" is a 300-page leather bound book containing more material than many \$25 correspondence courses, the price is only \$3. The publishers will gladly send a copy free, for five days' inspection.

Send no money now. Merely mail the coupon on the right, enclosing your business card, or giving a reference. If you decide to keep the book, send the money. If not, mail the book back. Tear out and fill in the coupon now, before you turn the page.

Name.....
Address.....
City.....State.....

Pelton Pub. Co. 30-H WILCOX BLOCK MERIDEN, CONN.

Partial Contents

- The Law of Great Thinking.
- The Four Factors on which it Depends.
- How to develop analytical power.
- How to think "all around" any subject.
- How to throw the mind into deliberate, controlled, productive thinking.
- Detailed directions for Perfect Mind Concentration.
- How to acquire the Power of Consecutive Thinking, Reasoning, Analysis.
- How to acquire the skill of Creative Writing.
- How to guard against errors in Thought.
- How to drive from the mind all unwelcome thoughts.
- How to follow any line of thought with keen, concentrated Power.
- How to develop Reasoning power.
- How to Handle the Mind in Creative Thinking.
- The secret of Building Mind Power.
- How the Will is made to act.
- How to test your Will.
- How a Strong Will is Master of Body.
- What creates Human Power.

What Users Say

- "I hand you \$3 in payment; from what I have already seen I believe I can get \$300 to \$30,000 worth of good out of it."—C. D. Van Vechten, General Agent, No. West Life Ins. Co., Cedar Rapids, Ia.
- "'Will Power' is a compilation of mighty force. My first week's benefit in dollars is \$900.00—cost \$3.00; profit \$897.00."—J. W. Heistand, 916 Tribune Bldg., Chicago, Ill.
- "In my judgment 'Power of Will' is wonderful."—Owen J. McCaughey, Secy. of Corp. Securities Co., St. Louis, Mo.
- "Enclosed find check; send 15 copies to our New York Office."—W. M. Taylor, Efficiency Expert the Overland Auto Co., Toledo.
- "The character of 'Power of Will' is such that he who reads and puts forth effort will soon find himself out of the common herd."—F. A. Good, Pres. of Neb. Lumber Dealers' Assn., Cowles, Neb.
- "I have carefully gone over 'Power of Will' and find it admirable."—Chas. Olin, Editorial Rooms, Boston Evening Transcript, Boston, Mass.

SMITHSONIAN INSTITUTION LIBRARIES



3 9088 01699 2299